

Galt



G500 Series Inverter

Operation Manual

Preface

Thank you for choosing the Galt Electric products. We have created a series of instructional guides and video tutorials to assist in your installation and improve your over-all experience. If you have any questions, please contact your distributor or our support department at support@galtelectric.com.



Digital Manual of the G500 Series Inverter



Quick Start Guide



Installation Guide



Programming Guide



Troubleshooting Guide



Maintenance Guide

Contents

Preface	i
Contents	ii
1 Safety precautions	1
1.1 What this chapter contains	1
1.2 Safety definition.....	1
1.3 Warning symbols.....	1
1.4 Safety guidelines.....	2
2 Quick start	5
2.1 What this chapter contains	5
2.2 Unpack inspection.....	5
2.3 Application confirmation.....	5
2.4 Environment confirmation.....	6
2.5 Installation confirmation.....	6
2.6 Basic commissioning.....	7
2.7 Safety standard related data.....	7
3 Product overview	8
3.1 What this chapter contains	8
3.2 Basic principle.....	8
3.3 Product specification	9
3.4 Product nameplate	12
3.5 Model Number.....	12
3.6 Rated specifications	13
3.7 Structure diagram.....	15
4 Installation guide	17
4.1 What this chapter contains	17
4.2 Mechanical installation	17
4.3 Standard wiring of main circuit.....	23
4.4 Standard wiring of control circuit.....	30
4.5 Wiring protection	33
5 Basic operation instructions	35
5.1 What this chapter contains	35
5.2 Keypad introduction.....	35
5.3 Keypad display.....	38
5.4 Operating the inverter through the keypad.....	40
5.5 Basic operation instruction.....	52
6 Parameters	133
6.1 What this chapter contains	133
6.2 Parameter list.....	133
7 Troubleshooting	278

7.1 What this chapter contains	278
7.2 Indications of alarms and faults	278
7.3 Fault reset.....	278
7.4 Fault history	278
7.5 Inverter faults and solutions.....	278
7.6 Analysis on common faults	287
7.7 Countermeasures on common interference	294
8 Maintenance and hardware fault diagnosis.....	298
8.1 What this chapter contains	298
8.2 Periodical inspection	298
8.3 Cooling fan.....	301
8.4 Capacitor	302
8.5 Power cable	303
9 Communication protocol.....	304
9.1 What this chapter contains	304
9.2 Modbus protocol introduction.....	304
9.3 Application of Modbus	304
9.4 RTU command code and communication data.....	310
9.5 Common communication faults.....	325
Appendix A Expansion cards.....	326
A.1 Model definition.....	326
A.2 Dimensions and installation.....	336
A.3 Wiring.....	339
A.4 IO cards.....	339
A.5 Programmable card (EC-PC502-00).....	343
A.6 Communication cards	346
A.7 PG cards	355
A.8 IoT cards	372
Appendix B Technical data.....	374
B.1 What this chapter contains	374
B.2 Derated application.....	374
B.3 Grid specifications.....	376
B.4 Motor connection data.....	376
B.5 Application standards	376
B.6 EMC regulations	377
Appendix C Dimension drawings.....	379
C.1 What this chapter contains.....	379
C.2 Keypad structure	379
C.3 Inverter structure	380
C.4 Dimensions of Inverters of AC 3PH 200V–240V and 380V–440V	380
C.5 Dimensions of Inverters of AC 3PH 520V–600V	386

Appendix D Optional peripheral accessories	390
D.1 What this chapter contains	390
D.2 Wiring of peripheral accessories	390
D.3 Power supply	392
D.4 Cables	392
D.5 Breaker and electromagnetic contactor	396
D.6 Reactors	399
D.7 Filters	401
D.8 Brake system	404
Appendix E STO function description	408
E.1 STO function logic table	408
E.2 STO channel delay description	408
E.3 STO function installation checklist	409
Appendix F Acronyms and abbreviations	410
Appendix G Further information	411
G.1 Product and service queries	411
G.2 Feedback on Galt Electric Inverter manuals	411
G.3 Documents on the Internet	411

1 Safety precautions

1.1 What this chapter contains

Read this manual carefully and follow all safety precautions before moving, installing, operating and servicing the inverter. If these safety precautions are ignored, physical injury or death may occur, or damage may occur to the equipment.

If any physical injury or death or damage to the equipment occurs due to neglect of the safety precautions specified in the manual, Galt Electric is not responsible for any damages and is not legally bound in any manner.

1.2 Safety definition

Danger: Serious physical injury or even death may occur if related requirements are not followed.











Warning: Physical injury or damage to the equipment may occur if related requirements are not followed.



Note: Procedures taken to ensure proper operation.

Qualified electricians: People working on the device should take part in professional electrical and safety training, receive the certification and be familiar with all steps and requirements of installing, commissioning, operating and maintaining the device to prevent any emergencies.





1.3 Warning symbols

Warnings caution you about conditions which can result in serious injury or death and/or damage to the equipment, and advice on how to avoid the danger. The following warning symbols are used in this manual.

Symbols	Name	Instruction	Abbreviation
 Danger	Danger	Serious physical injury or even death may occur if related requirements are not followed	
 Warning	Warning	Physical injury or damage to the equipment may occur if related requirements are not followed	
 Forbid	Electrostatic discharge	Damage to the PCBA board may occur if related requirements are not followed	
 Hot	Hot sides	The base of the inverter may become hot. Do not touch.	
 5 min	Electric shock	As high voltage still presents in the bus capacitor after power off, wait for at least five minutes (or 15 min / 25 min, depending on the warning symbols on the machine) after power off to prevent electric shock	 5 min

Symbols	Name	Instruction	Abbreviation
	Read manual	Read the operation manual before operating the equipment	
Note	Note	Procedures taken to ensure proper operation	Note

1.4 Safety guidelines

	<ul style="list-style-type: none"> Only trained and qualified electricians are allowed to carry out related operations. Do not perform wiring, inspection or component replacement when power supply is applied. Ensure all the input power supplies are disconnected before wiring and inspection, and wait for at least the time designated on the inverter or until the DC bus voltage is less than 36V. The minimum waiting time is listed in the table below. <table border="1" data-bbox="292 596 936 798" style="margin-left: auto; margin-right: auto;"> <thead> <tr> <th colspan="2">Inverter model</th> <th>Min. waiting time</th> </tr> </thead> <tbody> <tr> <td>220V</td> <td>0.75–55kW (1–75HP)</td> <td>5 minutes</td> </tr> <tr> <td rowspan="3">460V</td> <td>1.5kW-110kW (2–150HP)</td> <td>5 minutes</td> </tr> <tr> <td>132–315kW (175–425HP)</td> <td>15 minutes</td> </tr> <tr> <td>350–500kW (475–675HP)</td> <td>25 minutes</td> </tr> <tr> <td>575V</td> <td>0.75kW–110kW (1–150HP)</td> <td>5 minutes</td> </tr> </tbody> </table> <p>Note: Unless otherwise specified, the power described in this manual refers to the ND power. For example, 0.75–55kW (1–75HP) described in the preceding table refers to the ND power.</p>	Inverter model		Min. waiting time	220V	0.75–55kW (1–75HP)	5 minutes	460V	1.5kW-110kW (2–150HP)	5 minutes	132–315kW (175–425HP)	15 minutes	350–500kW (475–675HP)	25 minutes	575V	0.75kW–110kW (1–150HP)	5 minutes
Inverter model		Min. waiting time															
220V	0.75–55kW (1–75HP)	5 minutes															
460V	1.5kW-110kW (2–150HP)	5 minutes															
	132–315kW (175–425HP)	15 minutes															
	350–500kW (475–675HP)	25 minutes															
575V	0.75kW–110kW (1–150HP)	5 minutes															
	<ul style="list-style-type: none"> Do not modify the inverter unless authorized; otherwise, fire, electric shock or other injuries may occur. 																
	<ul style="list-style-type: none"> The base of the heatsink may become hot during running. Do not touch to avoid burns. 																
	<ul style="list-style-type: none"> The electrical parts and components inside the inverter are electrostatic. Take measures to prevent electrostatic discharge during related operation. 																

1.4.1 Delivery and installation

	<ul style="list-style-type: none"> Install the inverter on fire-retardant material and keep the inverter away from combustible materials. Connect the optional brake components (brake resistors, brake units or feedback units) according to the wiring diagram. Do not operate a damaged or incomplete inverter. Do not touch the inverter with wet items or body parts; otherwise, electric shock may occur. Solid State motor overload protection reacts when an inverter reaches 150% of FLA.
---	---

Note:

- Select appropriate tools for delivery and installation to ensure a safe and proper operation of the inverter and to avoid physical injury or death. To ensure physical safety, the installation staff should take electrical and mechanical protective measures like wearing exposure shoes and working uniforms.
- Ensure there is no physical shock or vibration during delivery and installation.
- Do not carry the inverter by its front cover only as the cover may disconnect.
- The installation site should not allow children or general public access.
- The inverter cannot meet the requirements of low voltage protection in IEC61800-5-1 if the altitude of installation site is above 2000m.
- The inverter should be used in a suitable environment (see Section 4.2.1 "Installation environment" for details).
- Prevent screws, cables and other conductive parts from falling into the inverter,
- As leakage current of the inverter during operation may exceed 3.5mA, properly ground the inverter ensuring the grounding resistance is less than 10Ω. The conductivity of PE grounding conductor is the same with that of the phase conductor (with the same cross sectional area).
- R, S and T are the power input terminals, and U, V and W are output motor terminals. Connect the input power cables and motor cables properly; otherwise, damage to the inverter may occur.

1.4.2 Commissioning and running

	<ul style="list-style-type: none"> ● Disconnect all power sources applied to the inverter before terminal wiring, and wait for at least the time designated on the inverter after disconnecting the power sources. ● High voltage is present inside the inverter during operation. Do not carry out any maintenance on the inverter during running except for keypad setting. For products at voltage levels of 6, the control terminals form extra-low voltage circuits. Therefore, you need to prevent the control terminals from connecting to accessible terminals of other devices. ● The inverter may automatically start when P01.21 (restart after power down) is set to 1. Do not get close to the inverter and motor. ● The inverter cannot be used as an "Emergency-stop device". ● The inverter cannot act as an emergency brake for the motor; it is a must to install an appropriate mechanical brake device. ● Permanent magnet synchronous motor applications require the following additional precautions and requirements before installation and maintenance. <ol style="list-style-type: none"> 1. Disconnect all the input power sources including main power and control power. 2. Ensure the permanent-magnet synchronous motor has been stopped,
---	---

	<p>and the voltage on output end of the inverter is lower than 36V.</p> <ol style="list-style-type: none"> 3. After the permanent-magnet synchronous motor is stopped, wait for at least the time designated on the inverter, and ensure the voltage between "+" and "-" is lower than 36V. 4. Ensure that the permanent-magnet synchronous motor cannot run by the action of the external load; it is recommended to install an effective external brake device or disconnect the direct electrical connection between the permanent-magnet synchronous motor and the inverter.
--	--

Note:

- To avoid damage, do not switch on and off the input power source of the inverter too frequently;
- For inverters that have been stored for a long time, check/reform the capacitance and carry out inspection and pilot run on the inverter before use.
- Close the front cover before running; otherwise, electric shock may occur.

1.4.3 Maintenance and component replacement

	<ul style="list-style-type: none"> ● Only well-trained and qualified professionals are allowed to perform maintenance, inspection, and component replacement on the inverter. ● Disconnect all the power sources applied to the inverter before terminal wiring, and wait for at least the time designated on the inverter after disconnecting the power sources. ● Take measures to prevent screws, cables and other conductive matters from falling into the inverter during maintenance and component replacement.
---	--

Note:

- Use proper torque to tighten the screws.
- Keep the inverter and its parts and components away from combustible materials during maintenance and component replacement.
- Do not carry out insulation voltage-endurance test on the inverter, or measure the control circuits of the inverter with a megohmmeter.
- Take proper anti-static measures while working on the inverter and its internal parts during maintenance and component replacement.

1.4.4 What to do after Scrapping

	<p>The heavy metals inside the inverter should be treated as an industrial waste and disposed of properly.</p>
---	--

2 Quick start



Scan this QR code or go to www.galteletric.com/support/g500/quick-start-guide to see video instructions of the quick start guide.

2.1 What this chapter contains

This chapter introduces the basic principles required during installation commissioning. Users can realize quick installation commissioning by following these principles.

2.2 Unpack inspection

Check as follows after receiving products.

1. Check whether the packing box is damaged or dampened. If yes, contact local dealers or company offices.
2. Check the model identifier on the exterior surface of the packing box is consistent with the purchased model. If no, contact local dealers or company offices.
3. Check whether the interior surface of packing box is improper, for example, in wet condition, or whether the enclosure of the inverter is damaged or cracked. If yes, contact local dealers or company offices.
4. Check whether the nameplate of the inverter is consistent with the model identifier on the exterior surface of the packing box. If not, contact local dealers or company offices.
5. Check whether the accessories (including user's manual, control keypad and expansion card units) inside the packing box are complete. If not, contact local dealers or company offices.

2.3 Application confirmation

Check the following items before operating on the inverter.

1. Verify the mechanical load type to be driven by the inverter, and check whether overload occurs during inverter operation and whether the inverter power class needs to be increased.
2. Check whether the actual running current of motor load is less than rated inverter current.
3. Check whether the control precision required by actual load is equal with the control precision provided by the inverter.
4. Check whether the grid voltage is consistent with inverter rated voltage.
5. Check whether desired functionality requires an optional expansion card.

2.4 Environment confirmation

Check the following items before use.

1. Check whether the ambient temperature of the inverter during actual application exceeds 40°C, if yes, derate 1% for every additional 1°C (for details, see Section B.2.2 "Derating"). In addition, do not use the inverter when the ambient temperature exceeds 50°C. Note: For cabinet-type inverter installation, ambient temperature is the air temperature inside the cabinet.
2. Check whether ambient temperature of the inverter during actual application is below -10°C, if yes, install space heaters. Note: For cabinet-type inverter, ambient temperature is the air temperature inside the cabinet.
3. Check whether the altitude of the application site exceeds 1000m, if yes, derate 1% for every additional 100 m.
4. Check whether the humidity of application site exceeds 90%, if yes, check whether condensation occurred, if condensation does exist, take additional protective measures.
5. Check whether there is direct sunlight or rodent intrusion potential, if yes, take additional protective measures.
6. Check whether there is dust, explosive or combustible gases at the application site, if yes, take additional protective measures meeting local code requirements.

2.5 Installation confirmation

After the inverter is installed properly, check the installation condition of the inverter.

1. Check whether the input power cable and current-carrying capacity of the motor cable fulfill actual load and code requirements.
2. Check whether peripheral accessories (including input reactors, input filters, output reactors, output filters, DC reactors, brake units and brake resistors) of the inverter are of the correct type and installed properly; check whether the installation cables fulfill requirements on current-carrying capacity.
3. Check whether the inverter is installed on fire-retardant materials; check whether the hot parts (reactors, brake resistors, etc.) are kept away from combustible materials.
4. Check whether all the control cables are routed separately from power cables based on EMC requirement.
5. Check whether all the grounding systems are grounded properly according to inverter requirements.
6. Check whether installation spacing of the inverter complies with the requirements in the operation manual.
7. Check whether installation method of the inverter complies with the requirements in the operation manual. Vertical installation should be adopted whenever possible.
8. Check whether external connecting hardware for the inverter are firm and tight enough, and whether the rating and installation method is compatible with the load requirement.
9. Check and assure there are no loose or redundant screws, cables or other conductive objects inside the inverter, if yes, correct.

2.6 Basic commissioning

Carry out basic commissioning according to the following procedures before operation of the inverter.

- | |
|---|
| 1. Select inverter control mode according to actual motor type and parameter requirements. |
| 2. Whether autotuning is needed? If possible, disconnect the motor load to carry out dynamic parameter autotuning; if the load cannot be disconnected, perform static autotuning. |
| 3. Adjust the acceleration and deceleration time based on actual working conditions of the load. |
| 4. Use jogging to carry out device commissioning. Check whether the motor running direction is consistent with the direction required, if no, it is recommended to change the motor running direction by exchanging the motor wiring of any two phases. |
| 5. Set all the control parameters, and carry out actual operation. |

2.7 Safety standard related data

IEC/EN 61508 (type A system)							ISO 13849**			
SIL	PFH	HFT	SFF	λ_{du}	λ_{dd}	PTI*	PL	CCF	DC	Category
2	8.73×10^{-10}	1	71.23%	1.79×10^{-9}	0	1 year	d	57	60%	3

* PTI: proof test interval.

** According to the categorization defined in EN ISO 13849-1.

3 Product overview

3.1 What this chapter contains

This chapter introduces the operation principles, product features, layouts, nameplates and model instructions.

Note: Unless otherwise specified, the power described in this chapter refers to the ND power. For example, 0.75–55kW (1–75HP) described in this chapter refers to the ND power.

3.2 Basic principle

The G500 series inverter is designed to control both asynchronous AC induction motors and permanent-magnet synchronous motors. The figure below shows the main circuit diagram of the inverter. The rectifier converts 3PH AC voltage into DC voltage, and the capacitor bank of intermediate circuit stabilizes the DC voltage. The inverter converts DC voltage into the AC voltage used by AC motor. When the circuit voltage exceeds the maximum limit value, external brake resistor will be connected to intermediate DC circuit to consume the feedback energy.

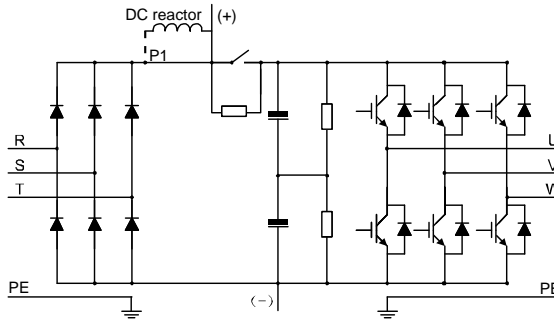

Figure 3-1 Main circuit of inverters of 220V 18.5–55kW (25–75HP); 460V ≥37kW (50HP)

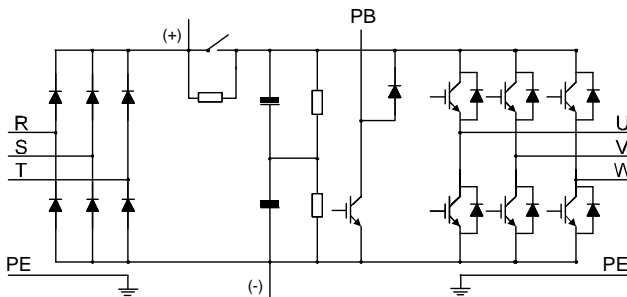

Figure 3-2 Main circuit of inverters of 220V ≤15kW (20HP); 460V ≤30kW (40HP)

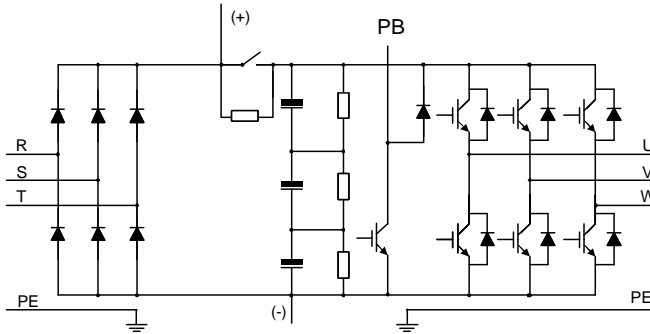

Figure 3-3 Simplified main circuit diagram of inverters of 575V ≤ 18.5kW (25HP)

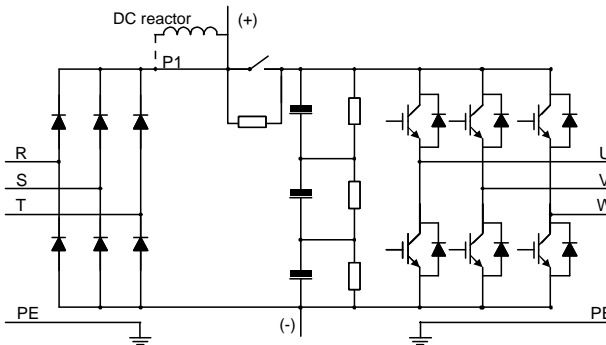

Figure 3-4 Simplified main circuit diagram of inverters of 575V ≥ 22kW (30HP)

Note:

1. The inverters of 220V 18.5–55kW (25–75HP) and 460V ≥ 37kW (50HP) support external DC reactors and external braking units, but it is necessary to remove the copper tag between P1 and (+) before connecting. DC reactors and external braking units are optional.
2. The inverters of 220V ≤ 15kW (20HP), 460V ≤ 30kW (40HP) support external braking resistors which are optional.
3. The inverters of 575V supports external DC reactors and external braking units, but it is necessary to remove the copper tag between P1 and (+) before connecting. DC reactors and external braking units are optional.

3.3 Product specification

Function description		Specification
Power input	Input voltage (V)	AC 3PH 200V–240V Rated voltage: 220V AC 3PH 380V–480V Rated voltage: 460V AC 3PH 520V–600V Rated voltage: 575V

Function description		Specification
	Allowable voltage fluctuation	-15%→+10%
	Input current (A)	See Section 3.6 "Rated specifications".
	Input frequency (Hz)	50Hz or 60Hz, allowable range: 47–63Hz
Power output	Output voltage (V)	0–input voltage
	Output current (A)	See Section 3.6 "Rated specifications".
	Output power (kW)	See Section 3.6 "Rated specifications".
	Output frequency (Hz)	0–400Hz
Technical control performance	Control mode	SVPWM control, SVC, FVC
	Motor type	Asynchronous motor, permanent-magnet synchronous motor
	Speed regulation ratio	Asynchronous motor 1: 200 (SVC); Synchronous motor 1: 20 (SVC), 1:1000 (FVC)
	Speed control precision	±0.2% (SVC), ±0.02% (FVC)
	Speed fluctuation	± 0.3% (SVC)
	Torque response	<20ms SVC), <10ms (FVC)
	Torque control precision	10% (SVC), 5% (FVC)
	Starting torque	Asynchronous motor: 0.25Hz/150% (SVC) Synchronous motor: 2.5 Hz/150% (SVC) 0Hz/200% (FVC)
Overload capacity	120% of the rated current: 1 minute 150% of the rated current: 10 seconds 180% of the rated current: 1 second	
Running control performance	Frequency setting mode	Digital, analog, pulse frequency, multi-step speed running, simple PLC, PID, Modbus communication, PROFIBUS communication, etc; Recognize the switch-over between the set combination and the set channel
	Automatic voltage regulation function	Keep the output voltage constant when grid voltage changes
	Fault protection function	Fault protection function Provide over 30 types of fault protection functions, including overcurrent, overvoltage, undervoltage, over-temperature, phase loss and overload, etc
	Speed tracking restart function	Realize impact-free starting of the motor in rotating Note: This function is available for 4kW (5HP) and above models
Peripheral interface	Terminal analog input resolution	No more than 20mV

Function description		Specification
	Terminal digital input resolution	No more than 2ms
	Analog input	2 inputs, AI1: 0–10V/0–20mA; AI2: -10–10V
	Analog output	1 output, AO1: 0–10V /0–20mA
	Digital input	Four regular inputs; max. frequency: 1kHz; internal impedance: 3.3kΩ Two high-speed inputs; max. frequency: 50kHz; supports quadrature encoder input; with speed measurement function
	Digital output	One high-speed pulse output; max. frequency: 50kHz One Y terminal open collector output
	Relay output	Two programmable relay outputs RO1A NO, RO1B NC, RO1C common port RO2A NO, RO2B NC, RO2C common port Contact capacity: 3A/AC250V, 1A/DC30V
	Extension interface	Three extension interfaces: SLOT1, SLOT2, SLOT3 Expandable PG card, programmable expansion card, communication card, I/O card, etc
Others	Installation mode	Wall-mounting, floor-mounting and flange-mounting
	Temperature of running environment	-10–50°C, derating is required if the ambient temperature exceeds 40°C. For details about derating, see Section B.2.2 "Derating".
	Enclosure Rating	IP20
	Cooling mode	Air cooling
	Brake unit	Built-in for inverters of 220V ≤15kW (20HP) and 460V ≤30kW (40HP), and 575V ≤ 18.5kW (25HP); optional for inverters of 220V 18.5–55kW (25–75HP), 460V ≥37kW (50HP), and 575V ≥ 22kW (30HP)
	EMC filter	380V models fulfill the requirements of IEC61800-3 C3 Optional external filter should meet the requirements of IEC61800-3 C2
	Overvoltage category	For input voltage 220-240V: transient surge suppression shall be installed on the line side of this equipment and shall be rated 220V (phase to ground), 220V (phase to phase), suitable for overvoltage category III, and shall provide protection for a rated impulse withstand voltage peak of 4kV. For input voltage 323-480V: transient surge suppression shall be installed on the line side of this equipment and shall be rated 480V (phase to ground), 480V (phase to phase), suitable for overvoltage category III, and shall provide protection for a rated impulse withstand voltage peak of 6kV.

Function description		Specification
		For input voltage 323-480V: transient surge suppression shall be installed on the line side of this equipment and shall be rated 575V (phase to ground), 575V (phase to phase), suitable for overvoltage category III, and shall provide protection for a rated impulse withstand voltage peak of 6kV.

3.4 Product nameplate

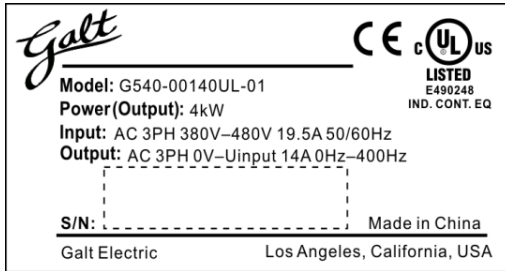

Figure 3-5 Product nameplate

Note: This is an example of the nameplate of the G500 inverters. The certification labels on the top right will be shown according to the actual certifications.

3.5 Model Number

The model number contains product information. You can find the model number on the inverter.

G540-00140UL-01

Inverter Model	Voltage Class	Rated Power	Software Version
G520	2: Three-phase 200V class 200V-240V	Inverter capacity amperage / 10 (00140 = 14A output)	Factory generation software version
G540	4: Three-phase 400V class 380V-480V	Inverter capacity amperage / 10 (00140 = 14A output)	
G560	6: Three-phase 600V class 520V-600V	Inverter capacity amperage / 10 (00140 = 14A output)	

3.6 Rated specifications

3.6.1 AC 3PH 200V–240V

Model number	Input Amps	Amps for duty (NEC)		HP for duty		Power rating (kW)
		Amps LD (120%)	Amps ND (150%)	HP LD (120%)	HP ND (150%)	
G520-00045UL-XX	5	/	4.5	/	1	0.75
G520-00070UL-XX	7.7	/	7	/	2	1.5
G520-00100UL-XX	11	/	10	/	3	2.2
G520-00160UL-XX	17	/	16	/	5	4
G520-00200UL-XX	21	/	20	/	7.5	5.5
G520-00300UL-XX	31	/	30	/	10	7.5
G520-00420UL-XX	43	/	42	/	15	11
G520-00550UL-XX	56	/	55	/	20	15
G520-00700UL-XX	71	/	70	/	25	18.5
G520-00800UL-XX	81	/	80	/	30	22
G520-01100UL-XX	112	/	110	/	40	30
G520-01300UL-XX	132	/	130	/	50	37
G520-01600UL-XX	163	/	160	/	45	45
G520-02000UL-XX	200	/	200	/	75	55

Note:

- The input current of 0.75–55 kW (1–75HP) inverters is measured at the input voltage of 220V without reactors.
- The rated output current is the output current measured at the output voltage of 220V.
- Within the allowable input voltage range, the output current/power cannot exceed the rated output current/power.

3.6.2 AC 3PH 380V–480V

Model number	Input Amps	Amps for duty (NEC)		HP for duty		Power rating (kW)
		Amps LD (120%)	Amps ND (150%)	HP LD (120%)	HP ND (150%)	
G540-00037UL-XX	5.0	3.7	3.7	2	2	1.5
G540-00050UL-XX	5.8	5	5	3	3	2.2
G540-00140UL-XX	13.5	14	9.5	10	5	4
G540-00185UL-XX	19.5	18.5	14	10	7.5	5.5
G540-00250UL-XX	25	25	18.5	15	10	7.5
G540-00320UL-XX	32	32	25	20	15	11
G540-00380UL-XX	40	38	32	25	20	15
G540-00450UL-XX	47	45	38	30	25	18.5
G540-00600UL-XX	56	60	45	40	30	22
G540-00750UL-XX	70	75	60	50	40	30

Model number	Input Amps	Amps for duty (NEC)		HP for duty		Power rating (kW)
		Amps LD (120%)	Amps ND (150%)	HP LD (120%)	HP ND (150%)	
G540-00920UL-XX	80	92	75	60	50	37
G540-01150UL-XX	94	115	92	75	60	45
G540-01500UL-XX	160	150	115	100	75	55
G540-01800UL-XX	160	180	150	150	100	75
G540-02150UL-XX	190	215	180	175	150	90
G540-02600UL-XX	265	260	215	200	150	110
G540-03050UL-XX	265	305	260	250	175	132
G540-03400UL-XX	310	340	305	250	250	160
G540-03800UL-XX	345	380	340	300	250	185
G540-04250UL-XX	385	425	380	350	300	200
G540-04800UL-XX	430	480	425	400	350	220
G540-05300UL-XX	485	530	480	450	400	250
G540-06000UL-XX	545	600	530	500	450	280
G540-06500UL-XX	610	650	600	500	500	315
G540-07200UL-XX	625	720	650	600	550	350
G540-08600UL-XX	890	860	-	700	-	400
G540-08600HDUL-XX	890	-	860	-	700	500

Note:

- The input current of 1.5–200kW (2–270HP) inverters is measured at the input voltage of 460V without reactors.
- The input current of 220–500kW (270—75HP) inverters is measured at the input voltage of 460V with reactors.
- The rated output current is the output current measured at the output voltage of 460V.
- Within the allowable input voltage range, the output current/power cannot exceed the rated output current/power.

3.6.3 AC 3PH 520V–600V

Model number	Input Amps	Amps for duty (NEC)		HP for duty		Power rating (kW)
		Amps LD (120%)	Amps ND (150%)	HP LD (120%)	HP ND (150%)	
G560-00021UL-XX	3.3	/	2.1	/	1	0.75
G560-00032UL-XX	5	/	3.2	/	2	1.5
G560-00045UL-XX	7	/	4.5	/	3	2.2
G560-00065UL-XX	10	/	6.5	/	5	4
G560-00090UL-XX	13	/	9	/	7.5	5.5
G560-00120UL-XX	16.5	/	12	/	10	7.5
G560-00160UL-XX	19	/	16	/	15	11
G560-00210UL-XX	24	/	21	/	20	15

Model number	Input Amps	Amps for duty (NEC)		HP for duty		Power rating (kW)
		Amps LD (120%)	Amps ND (150%)	HP LD (120%)	HP ND (150%)	
G560-00270UL-XX	29	/	27	/	25	18.5
G560-00350UL-XX	40	/	35	/	30	22
G560-00450UL-XX	47	/	45	/	40	30
G560-00520UL-XX	52	/	52	/	50	37
G560-00620UL-XX	65	/	62	/	60	45
G560-00860UL-XX	85	/	86	/	75	55
G560-00980UL-XX	95	/	98	/	100	75
G560-01200UL-XX	118	/	120	/	125	90
G560-01500UL-XX	145	/	150	/	150	110

Note:

- The input current of 0.75–110kW (1–150HP) inverters is measured at the input voltage of 575V without reactors.
- The rated output current is the output current measured at the output voltage of 575V.
- Within the allowable input voltage range, the output current/power cannot exceed the rated output current/power.

3.7 Structure diagram

The inverter layout is shown in the figure below (use the inverter of 460V 30kW/40HP as an example).

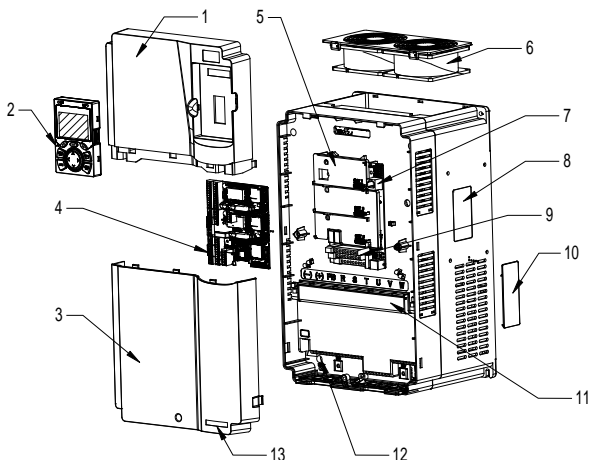

Figure 3-6 Structure diagram

No.	Name	Instruction
1	Upper cover	Protect internal components and parts
2	Keypad	See Section 5.2 "Keypad introduction" for details.
3	Lower cover	Protect internal components and parts

No.	Name	Instruction
4	Expansion card	Optional, see Appendix A "Expansion cards" for details.
5	Baffle of control board	Protect the control board and install expansion card
6	Cooling fan	See Chapter 8 "Maintenance and hardware fault diagnosis".
7	Keypad interface	Connect the keypad
8	Nameplate	See Section 3.4 "Product nameplate" for details.
9	Control terminals	See Chapter 4 "Installation guide" for details.
10	Cover plate of heat emission hole	Optional. Cover plate can upgrade protection level, however, as it will also increase internal temperature, derated use is required.
11	Main circuit terminal	See Chapter 4 "Installation guide" for details.
12	POWER indicator	Power indicator
13	Label of G500 series	See Section 3.5 "Model Number" for details.

4 Installation guide



Scan this QR code or go to www.galtelectric.com/support/g500/wiring-instructions to see video instructions of the installation guide.

4.1 What this chapter contains

This chapter introduces the mechanical and electrical installations of the inverter.

Note: Unless otherwise specified, the power described in this chapter refers to the ND power. For example, 0.75–55kW (1–75HP) described in this chapter refers to the ND power.

	<ul style="list-style-type: none"> • Only well trained and qualified professionals should perform the installation mentioned in this chapter. Be sure to install according to instructions presented in the Safety Precautions section. Ignoring these safety precautions may lead to physical injury or death, or device damage. • Ensure the inverter power is disconnected before installation. If the inverter has been powered on, disconnect the inverter and wait for at least the time designated on the inverter, and ensure the POWER indicator is off. Users are recommended to use a multimeter to check and ensure the inverter DC bus voltage is below 36V. • Installation must be designed and done according to applicable local laws and regulations. Galt Electric does not assume any liability whatsoever for any installation which breaches local laws and regulations. If recommendations given by Galt Electric are not followed, the inverter may experience problems that the warranty does not cover.
---	---

4.2 Mechanical installation

4.2.1 Installation environment

A proper installation environment is essential for the inverter to operate with long term reliability. The installation environment of the inverter should meet the following requirements.

Environment	Condition
Installation site	Indoor
Ambient temperature	<ul style="list-style-type: none"> • -10—+50°C • When the ambient temperature exceeds 40°C, derate 1% for every additional 1°C. For details about derating, see Section B.2.2 "Derating".

Environment	Condition
	<ul style="list-style-type: none"> ● It is not recommended to use the inverter when the ambient temperature is above 50°C. ● In order to improve reliability, do not use the inverter in cases where the temperature changes rapidly. ● When the inverter is used in a closed space eg control cabinet, use cooling fan or air conditioner to prevent internal temperature from exceeding the temperature required. ● When the temperature is below freezing, it is recommended to install an external heating device before use to eliminate component freezing inside the inverter, failing to do so may cause damage to the inverter.
Humidity	<ul style="list-style-type: none"> ● The relative humidity (RH) of the air is less than 90%. ● Condensation is not allowed. ● The max RH cannot exceed 60% in the environment where there are corrosive gases.
Storage temperature	-30—+60°C
Running environment	<p>The installation site should meet the following requirements.</p> <ul style="list-style-type: none"> ● Away from electromagnetic radiation sources. ● Away from oil mist, corrosive gases and combustible gases. ● Ensure foreign object like metal powder, dust, oil and water will not fall into the inverter (do not install the inverter onto combustible object like wood). ● Away from radioactive substance and combustible objects. ● Away from harmful gases and liquids. ● Low salt content. ● No direct sunlight
Altitude	<ul style="list-style-type: none"> ● Below 1000 m or 3300 ft. ● When the altitude exceeds 1000m, derate 1% for every additional 100m. ● When the altitude exceeds 2000m, configure an isolation transformer on the input of the inverter. It is recommended to keep the altitude below 5000m.
Vibration	The max. amplitude of vibration should not exceed 5.8m/s ² (0.6g)
Installation direction	Install the inverter vertically to ensure good heat dissipation effect

Note:

- G500 series inverter should be installed in a clean and well-ventilated environment based on the IP level.
- The cooling air must be clean enough and free from corrosive gases and conductive dust.

4.2.2 Installation direction

The inverter can be installed on the wall or in a cabinet.

The inverter must be installed vertically. Check the installation position according to following requirements. See Appendix C "Dimension drawings".

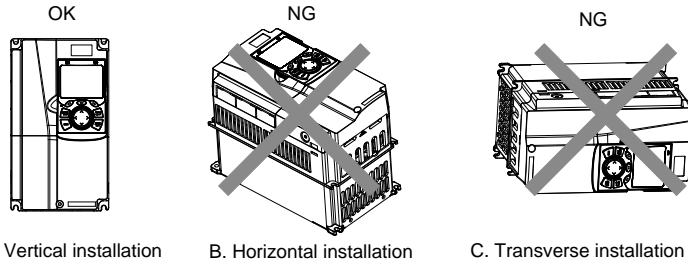

Figure 4-1 Installation direction of the inverter

4.2.3 Installation mode

There are three kinds of installation modes based on different inverter dimensions.

- Wall-mounting: for the inverters of $220V \leq 55kW/75HP$, $460V \leq 200kW/270HP$, and 575V.
- Flange-mounting: for the inverters of $220V \leq 55kW/75HP$, $460V \leq 200kW/270HP$, and 575V.
- Floor-mounting: for the inverters of 460V 220–500kW (300–675HP).

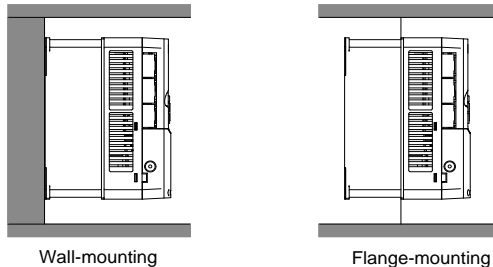

Figure 4-2 Installation mode

The installation steps are described as follows:

- (1) Mark the position of the installation hole. See appendix for the position of installation hole;
- (2) Mount the screws or bolts onto the designated position;
- (3) Put the inverter on the wall;
- (4) Tighten the fixing screws on the wall.

Note: Flange plates are required when installing inverters of 220V 0.75–15kW (1–20HP) and 460V in flange mode, and for inverters of 220V 18.5–55kW (25–75HP) and 460V 37–200kW (50–270HP), no flange plate is required.

4.2.4 Single-unit installation

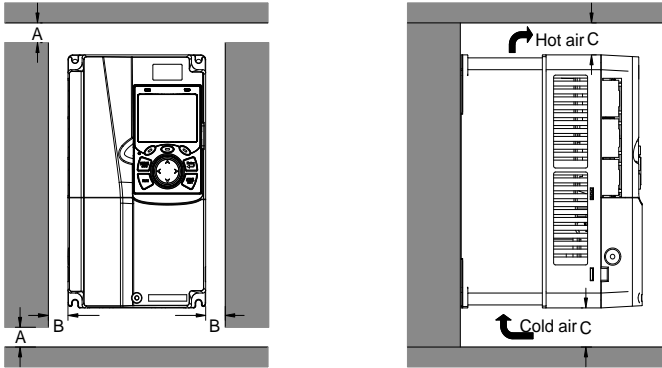

Figure 4-3 Single-unit installation

Note: The min. dimension of A, B, and C is 100mm.

4.2.5 Multiple-unit installation

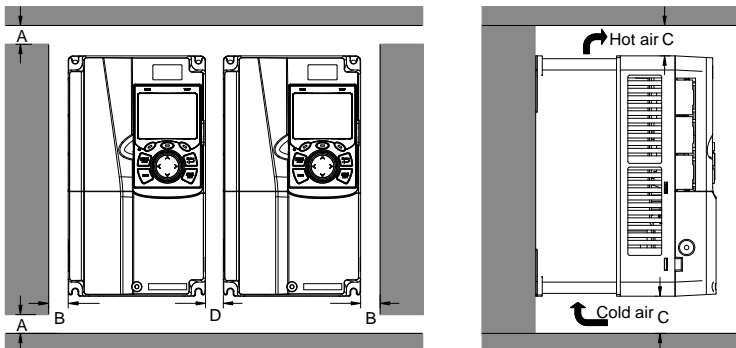

Figure 4-4 Parallel installation

Note:

- When users install inverters in different sizes, align the top of each inverter before installation for the convenience of future maintenance.
- The min. dimension of A, B, C and D is 100mm.

4.2.6 Vertical installation

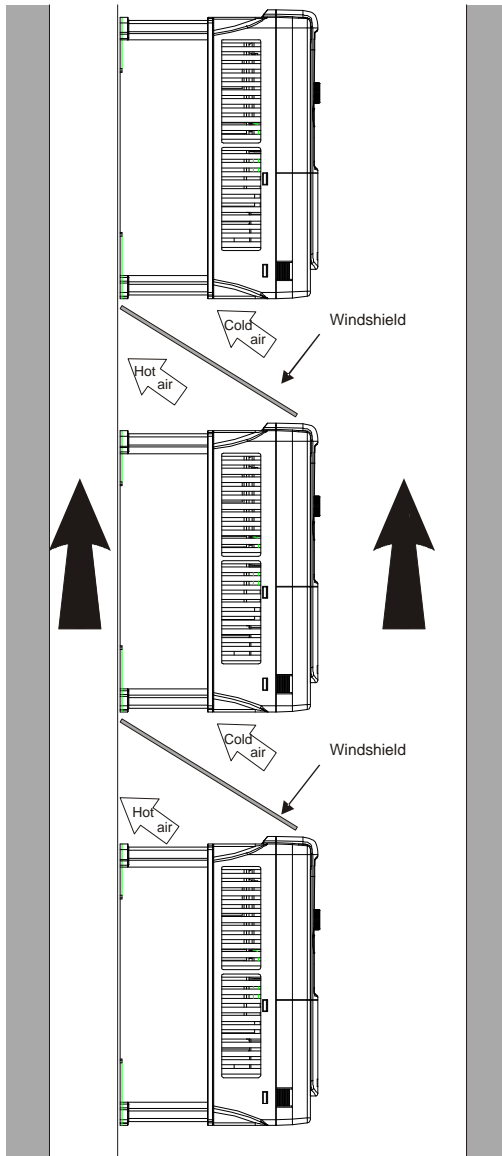

Figure 4-5 Vertical installation

Note: During vertical installation, users must install windshield, otherwise, the inverter will experience mutual interference, and the heat dissipation effect will be degraded.

4.2.7 Tilted installation

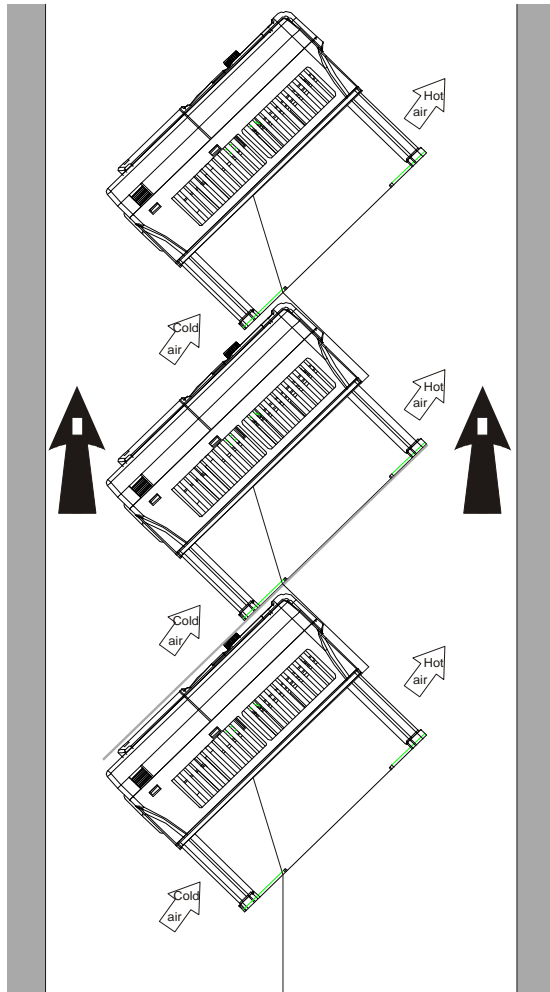

Figure 4-6 Tilted installation

Note: During tilted installation, it is a must to ensure the air inlet duct and air outlet duct are separated from each other to avoid mutual interference.

4.3 Standard wiring of main circuit

4.3.1 Wiring diagram of main circuit

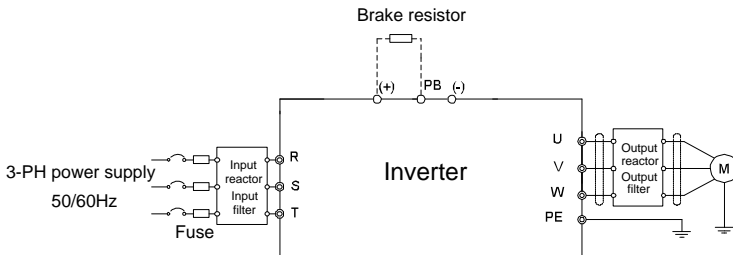

Figure 4-7 Connection diagram of main circuit for the inverter of 220V $\leq 15\text{kW}/20\text{HP}$ and 460V $\leq 30\text{kW}/40\text{HP}$

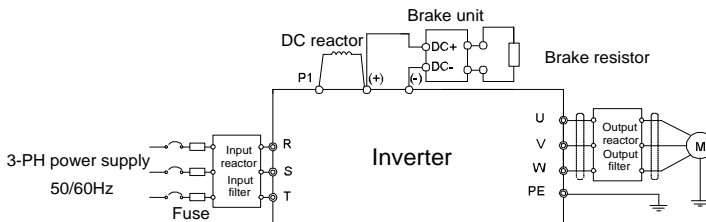

Figure 4-8 Connection diagram of main circuit for the inverters of 220V 18.5–55kW (25–75HP), and 460V $\geq 37\text{kW}/50\text{HP}$

Note:

- The fuse, DC reactor, brake unit, brake resistor, input reactor, input filter, output reactor, and output filter are optional parts. See Appendix D "Optional peripheral accessories" for details.
- P1 and (+) are short circuited in factory for inverters of 220V ($\geq 18.5\text{kW}/25\text{HP}$), 460V ($\geq 37\text{kW}/50\text{HP}$). If you need to use them to connect the DC reactor, remove the contact tag between P1 and (+).
- When connecting the brake resistor, take off the yellow warning signs marked with (+) and (-) on the terminal block before connecting the brake resistor wire. Otherwise, poor contact may occur.

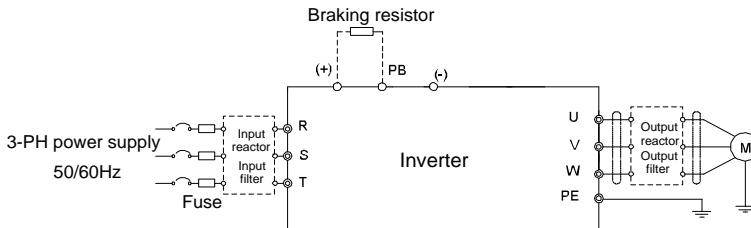

Figure 4-9 Connection diagram of main circuit for the inverters of 575V 0.75–18.5kW (1–25HP)

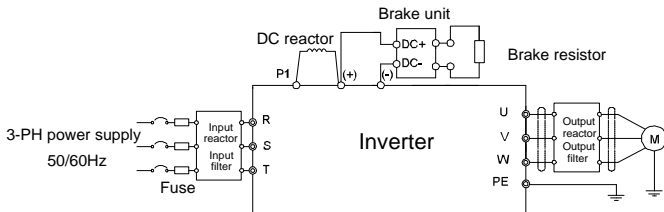

Figure 4-10 Connection diagram of main circuit for the inverters of 575V \geq 22kW (30HP)

Note:

- The fuse, DC reactor, brake resistor, input reactor, input filter, output reactor, and output filter are optional parts. See Appendix D "Optional peripheral accessories" for details.
- P1 and (+) are short circuited in factory. If you need to use them to connect the DC reactor, remove the contact tag between P1 and (+).

4.3.2 Main circuit terminal diagram

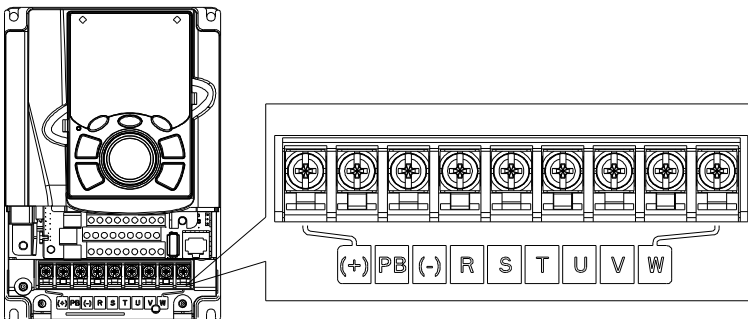

Figure 4-11 Terminals of main circuit for the inverters of 220V 0.75kW/1HP and 460V 1.5–2.2kW (2–3HP)

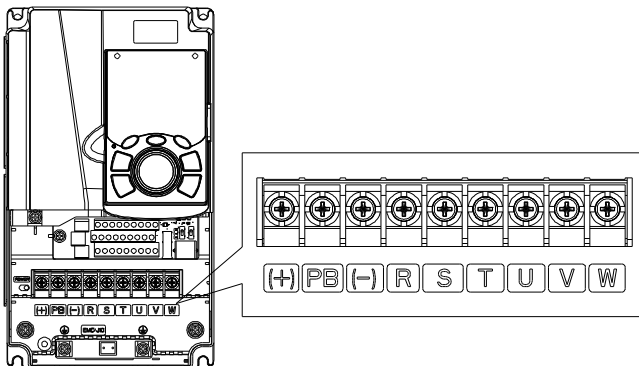

Figure 4-12 Terminals of main circuit for the inverters of 220V 1.5–2.2kW (2–3HP), 460V 4–5.5kW (5–7.5HP), and 575V 0.75–2.2kW (1–4.5HP)

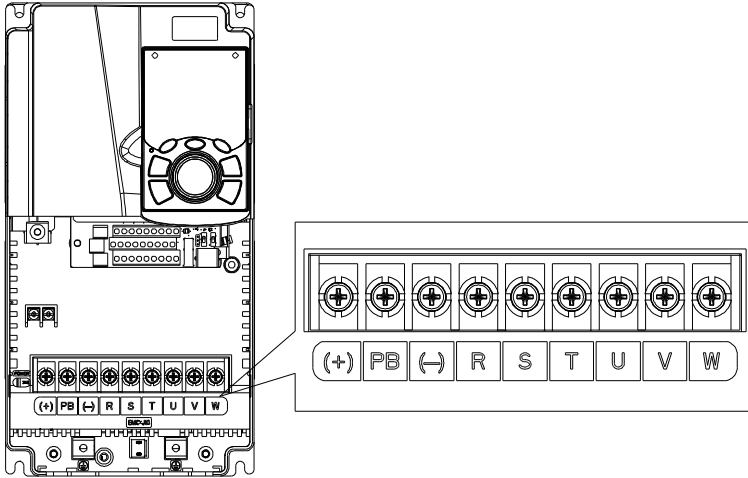

Figure 4-13 Terminals of main circuit for the inverters of 220V 4–5.5kW (5–7.5HP) and 460V 7.5–11kW (10–15HP), and 575V 4–7.5kW (5–10HP)

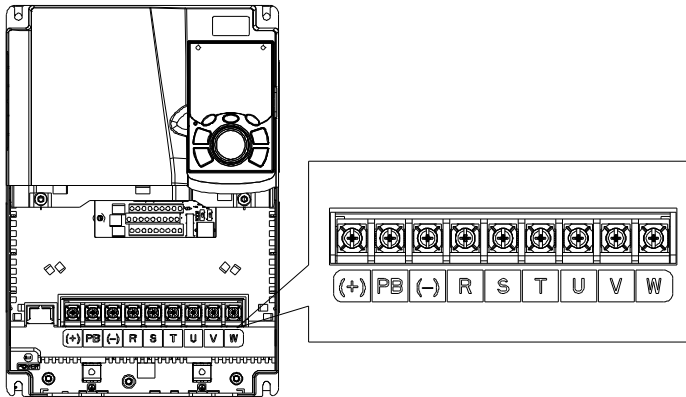

Figure 4-14 Terminals of main circuit for the inverters of 220V 7.5kW/10HP, 460V 15–18.5kW (20–25HP), and 575V 11–18.5kW (15–25HP)

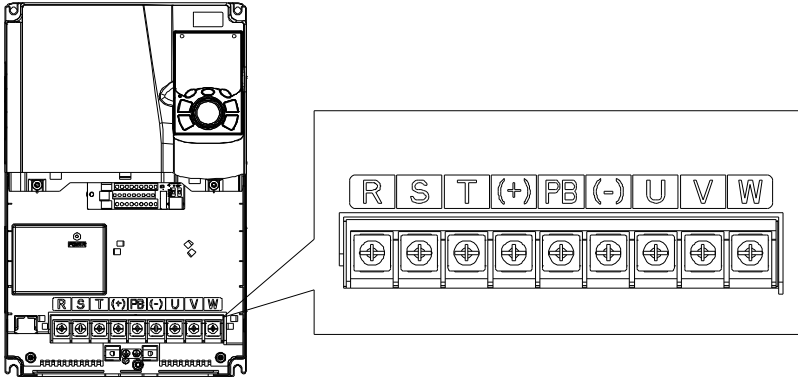

Figure 4-15 Terminals of main circuit for the inverters of 220V 11–15kW (15–20HP) and 460V 22–30kW (30–40HP)

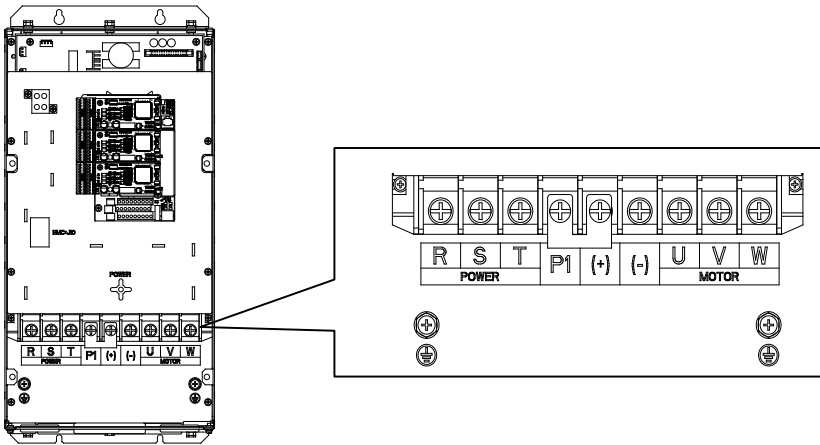

Figure 4-16 Terminals of main circuit for the inverters of 220V 18.5–30kW (25–40HP), and 460V 37–55kW (50–75HP), and 575V 22–37kW (30–50HP)

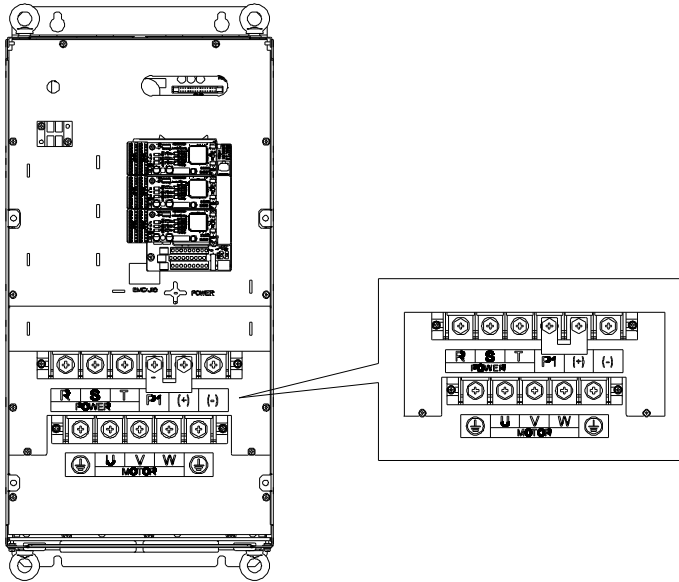

Figure 4-17 Terminals of main circuit for the inverters of 220V 37–55kW (50–75HP), 460V 75–110kW (100–150HP), and 575V 45–110kW (60–150HP)

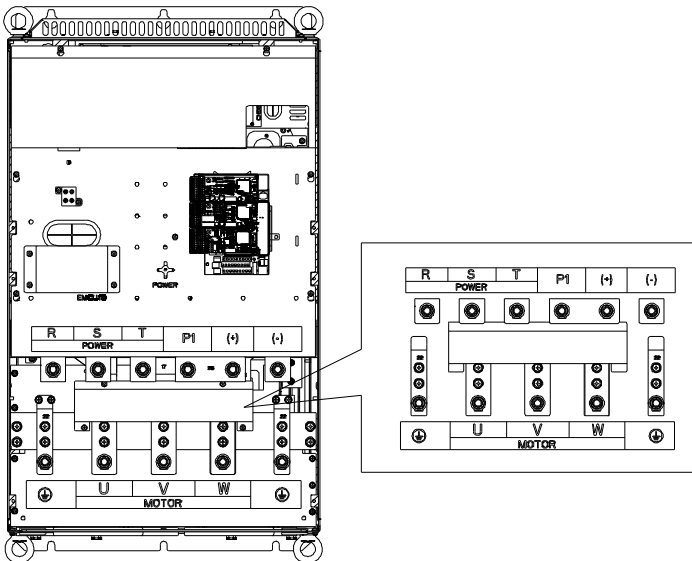

Figure 4-18 Terminals of main circuit for the inverters of 460V 132–200kW (175–270HP)

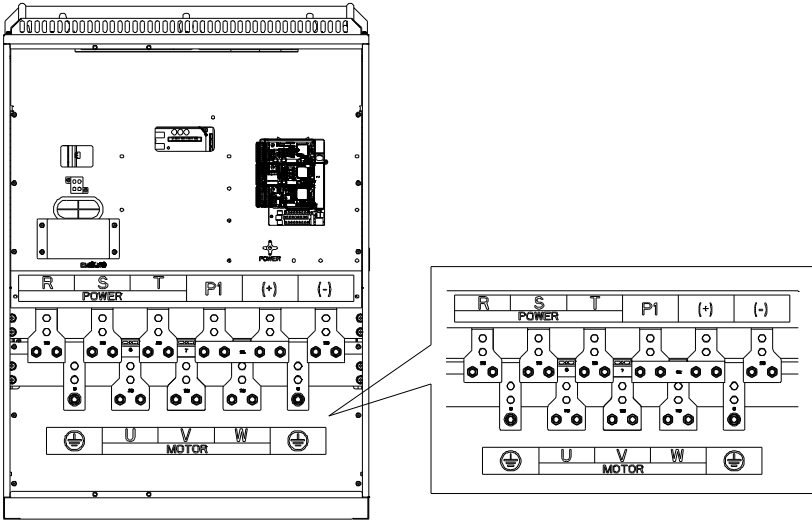

Figure 4-19 Terminals of main circuit for the inverters of 460V 220–315kW (300–425HP)

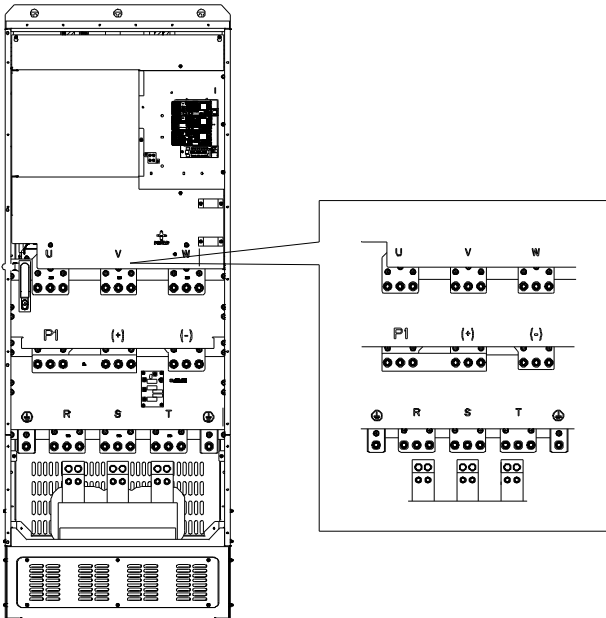

Figure 4-20 Terminals of main circuit for the inverters of 460V 350–500kW (475–675HP)

Terminal	220V ≤15kW	220V ≥18.5kW/25HP	Function
	460V ≤30kW	460V ≥37kW/50HP	
	575V ≤18.5kW	575V ≥22kW	
R, S, T	Power input of the main circuit		3-phase AC input terminals which are generally connected with the power supply.
U, V, W	The inverter output		3-phase AC output terminals which are generally connected with the motor.
P1	/	DC reactor terminal 1	P1 and (+) are connected with the terminals of DC reactor. (+) and (-) are connected with the terminals of braking unit.
(+)	Braking resistor 1	DC reactor terminal 2, braking unit terminal 1	
(-)	/	Braking unit terminal 2	
PB	Braking resistor 2	/	PB and (+) are connected with the terminals of braking resistor.
PE	Protective grounding terminal		Every machine is provided 2 PE terminals as the standard configuration. These terminals should be grounded with proper techniques. 460V: the grounding resistor is less than 10Ω
A1 and A2	Control power supply terminal		Optional parts (external 220V control power supply)

Note:

- It is not recommended to use asymmetrical motor cables (different size conductors for each phase). If there is a symmetrical grounding conductor in the motor cable besides the conductive shielded layer, ground the grounding conductor on the inverter end and motor end.
- Brake resistor, brake unit and DC reactor are optional parts.
- Route the motor cable, input power cable and control cables separately.
- If the terminal description is "/", the machine does not provide the terminal as the external terminal.

4.3.3 Wiring process of the main circuit terminals

- Connect the grounding line of the input power cable to the grounding terminal (PE) of the inverter, and connect the 3PH input cable to R, S and T terminals and tighten up.
- Connect the grounding line of the motor cable to the grounding terminal of the inverter, and connect 3PH motor cable to U, V and W terminals and tighten up.
- Connect the brake resistor which carries cables to the designated position.
- Fix all the cables outside the inverter mechanically if allowed.

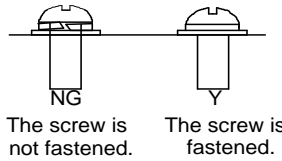

Figure 4-21 Screw installation diagram

4.4 Standard wiring of control circuit

4.4.1 Wiring diagram of basic control circuit

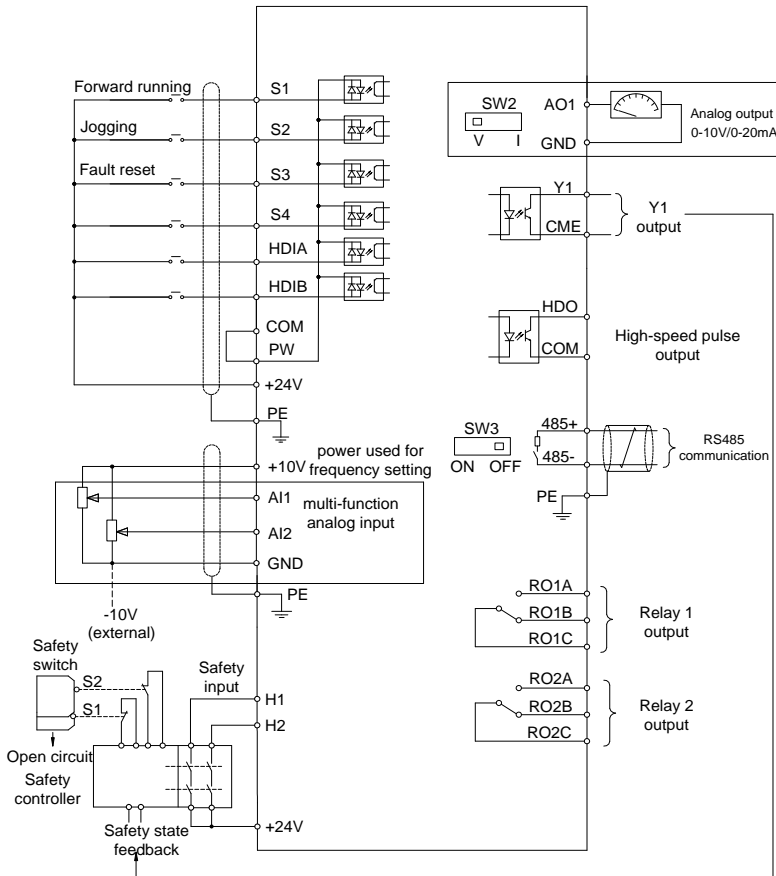

Figure 4-22 Wiring diagram of control circuit

Terminal name	Instruction	
+10V	The inverter provides +10.5V power	
AI1	<ul style="list-style-type: none"> Input range: AI1 voltage/current can choose 0–10/ 0–20mA; 	
AI2	<ul style="list-style-type: none"> AI2: -10V→+10V voltage; Input impedance: 20kΩ during voltage input; 250Ω during current input; AI1 voltage or current input is set by P05.50; Resolution ratio: When 10V corresponds to 50Hz, the min. resolution ratio is 5mV; 25°C, When input above 5V or 10mA, the error is ±0.5% 	
GND	Reference ground of +10.5V	
AO1	<ul style="list-style-type: none"> Output range: 0–10V voltage or 0–20mA current Voltage or current output is set by toggle switch SW2; 25°C, when input above 5V or 10mA, the error is ±0.5%. 	
RO1A	RO1 relay output; RO1A is NO, RO1B is NC, RO1C is common port Contact capacity: 3A/AC250V, 1A/DC30V	
RO1B		
RO1C		
RO2A	RO2 relay output; RO2A is NO, RO2B is NC, RO2C is common port Contact capacity: 3A/AC250V, 1A/DC30V	
RO2B		
RO2C		
HDO	<ul style="list-style-type: none"> Switch capacity: 200mA/30V; Range of output frequency: 0–50kHz Duty ratio: 50% 	
COM	Reference ground of +24V	
CME	Common port of open collector output; short connected to COM by default	
Y1	<ol style="list-style-type: none"> Switch capacity: 200mA/30V; Range of output frequency: 0–1kHz 	
485+	485 communication port, 485 differential signal port and standard 485 communication interface should use shielded twisted pair; the 120Ω terminal matching resistor of 485 communication is connected by toggle switch SW3.	
485-		
PE	Grounding terminal	
PW	External power input terminal for digital input circuits; Voltage range: 12–24V	
24V	The inverter provides user power; the maximum output current is 200mA	
S1	Digital input 1	<ul style="list-style-type: none"> Internal impedance: 3.3kΩ Accept 12–30V voltage input This terminal is bi-directional input terminal and supports NPN/PNP connection modes Max. input frequency: 1kHz For all are programmable digital input terminals, users can set the terminal function via function codes
S2	Digital input 2	
S3	Digital input 3	
S4	Digital input 4	

Terminal name	Instruction	
HDIA	Channels for both high frequency pulse input and S1–S4 inputs	
HDIB	Max. input frequency: 50kHz; Duty ratio: 30%–70%; Supports quadrature encoder input; equipped with speed-measurement function	
+24V—H1	STO input 1	<ul style="list-style-type: none"> Safe torque off (STO) redundant input, connect to external NC contact, STO acts when the contact opens, and the inverter stops output; Safety input signal wires use shielded wire whose length is within 25m; H1 and H2 terminals are short connected to +24V by default; it is required to remove the jumper on the terminal before using STO function.
+24V—H2	STO input 2	

4.4.2 Input/output signal connection diagram

Set NPN /PNP mode and internal/external power via U-shaped jumper. PNP internal mode is adopted by default.

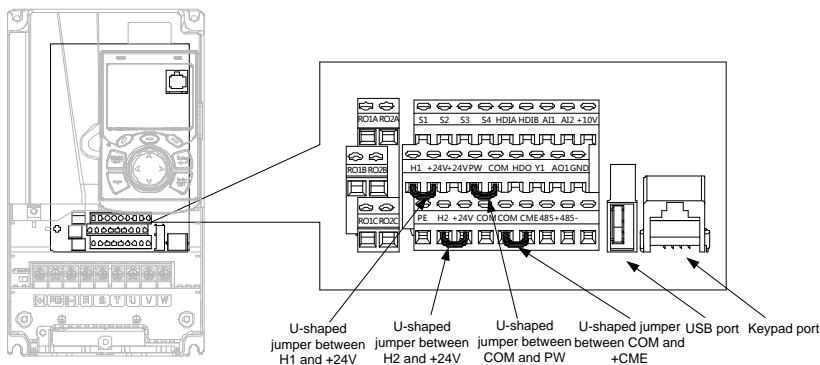

Figure 4-23 Position of U-shaped jumper

Note: As shown in Figure 4-23, the USB port can be used to upgrade the software, and the keypad port can be used to connect an external keypad. The external keypad cannot be used when the keypad of the inverter is used.

If input signal comes from NPN transistors, set the U-shaped jumper between +24V and PW based on the power used according to the figure below.

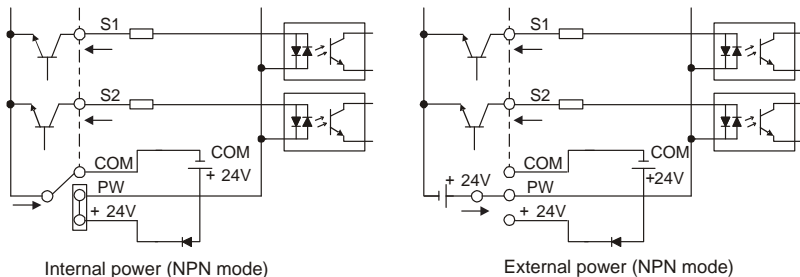

Figure 4-24 NPN mode

If input signal comes from PNP transistor, set the U-shaped jumper based on the power used according to the figure below.

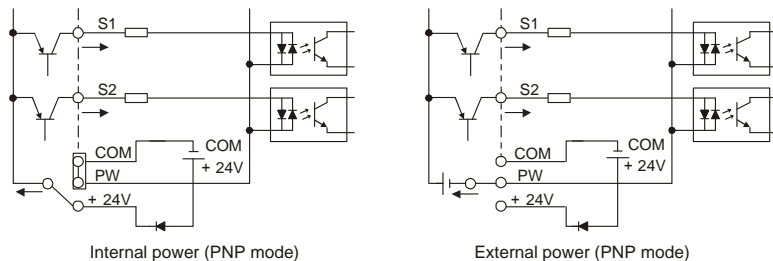

Figure 4-25 PNP mode

4.5 Wiring protection

4.5.1 Protect the inverter and input power cable in short-circuit

Protect the inverter and input power cable during short-circuit to avoid thermal overload.

Carry out protective measures according to the following requirements.

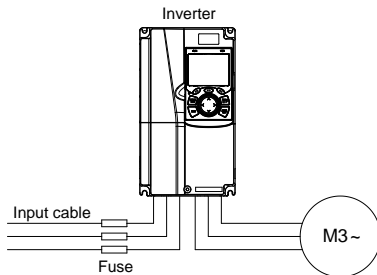

Figure 4-26 Fuse configuration

Note: Select the fuse according to operation manual. During short-circuit, the fuse will protect input power cables to avoid damage to the inverter; when internal short-circuit occurred to the inverter, it can protect neighboring equipment from being damaged.

4.5.2 Protect the motor and motor cable in short circuit

If the motor cable is selected based on rated inverter current, the inverter will be able to protect the motor cable and motor during short circuit without other protective devices.



If the inverter is connected to multiple motors, it is a must to use a separated thermal overload switch or breaker to protect the cable and motor, which may require the fuse to cut off the short circuit current.

4.5.3 Protect motor and prevent thermal overload

According to the requirements, the motor must be protected to prevent thermal overload. Once overload is detected, users must cut off the current. The inverter is equipped with motor thermal overload protection function, which will block output and cut off the current (if necessary) to protect the motor.

4.5.4 Bypass connection

In some critical occasions, industrial frequency conversion circuit is necessary to ensure proper operation of the system when inverter fault occurs.

In some special cases, eg, only soft startup is needed, it will convert to power-frequency operation directly after soft startup, corresponding bypass link is also needed.



Do not connect any power source to inverter output terminals U, V and W. The voltage applied to motor cable may cause permanent damage to the inverter.

If frequent switch-over is needed, users can use the switch which carries mechanical interlock or a contactor to ensure motor terminals will not be connected to input power cables and inverter output ends simultaneously.

5 Basic operation instructions

5.1 What this chapter contains

This chapter contains instructions of how to use the inverter keypad and how to perform common functions of the inverter.

5.2 Keypad introduction

The LCD keypad is included in the standard configuration of G500 series. Users can start and stop the inverter, read the operation status, and set parameters via the keypad.

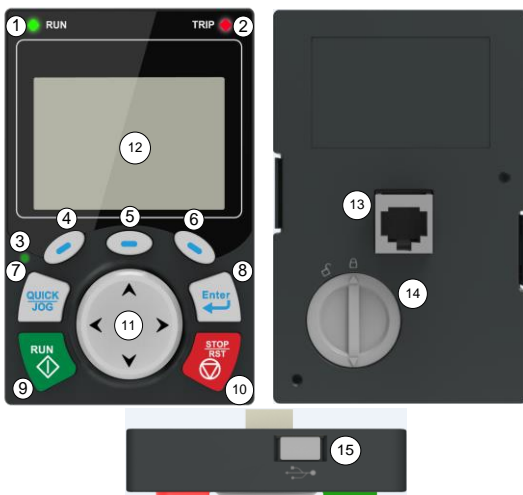















Figure 5-1 Keypad diagram

Note:

1. The LCD keypad is equipped with a real-time clock, which can continue to run after power off when installed with batteries. The clock battery (type: CR2032) is not included;
2. The LCD keypad supports parameter copying function;
3. When extending the keypad cable to install the keypad, M3 screws can be used to attach the keypad onto the door plate, or optional keypad installation bracket can be used. If you need to install the keypad on another position rather than on the inverter, use a keypad extension cable with a standard RJ45 connector.

No.	Name		Instruction
1	State Indicator	(1)	<p>RUN</p> <p>Running indicator; LED off – the inverter is stopped; LED blinking – the inverter is in parameter autotune LED on – the inverter is running</p>

No.	Name	Instruction			
		(2)		Fault indicator; LED on – in fault state LED off – in normal state LED blinking – in pre-alarm state	
		(3)		Short-cut key indicator, which displays different state under different functions, see definition of QUICK/JOG key for details	
2	Button area	(4)		Function key	The function of function key varies with the menu; The function of function key is displayed in the footer
		(5)			
		(6)			
		(7)		Short-cut key	Re-definable. It is defined as JOG function by default, namely jogging. The function of short-cut key can be set by the ones of P07.12, as shown below. 0: No function ; 1: Jogging (linkage indicator (3); logic : NO); 2: Reserved; 3: FWD/REV switch-over (linkage indicator (3); logic: NC) ; 4: Clear UP/DOWN setting (linkage indicator (3) logic: NC) ; 5: Coast to stop (linkage indicator (3); logic: NC) ; 6: Switching running command reference mode in order (linkage indicator (3); logic: NC) ; 7: Reserved; Note: After restoring to default values, the default function of short-cut key (7) is 1.
		(8)		Confirmation key	The function of confirmation key varies with menus, eg confirming parameter setting, confirming parameter selection, entering the next menu, etc.
		(9)		Running key	Under keypad operation mode, the running key is used for running operation or autotuning operation.
		(10)		Stop/Reset key	During running state, press the Stop/Reset key can stop running or autotuning; this key is limited by P07.04. During fault alarm state, all the control modes can be reset by this key.

No.	Name	Instruction			
		(11)		Direction key UP:  DOWN:  LEFT:  RIGHT: 	UP: The function of UP key varies with interfaces, eg shifting up the displayed item, shifting up the selected item, changing digits, etc; DOWN: The function of DOWN key varies with interfaces, eg shifting down the displayed item, shifting down the selected item, changing digits, etc; LEFT: The function of LEFT key varies with interfaces, eg switch over the monitoring interface, eg shifting the cursor leftward, exiting current menu and returning to previous menu, etc; RIGHT: The function of RIGHT key varies with interfaces, eg switch over the monitoring interface, shifting the cursor rightward, enter the next menu etc.
3	Display area	(12)	LCD	Display screen	240×160 dot-matrix LCD; display three monitoring parameters or six sub-menu items simultaneously
4	Others	(13)	RJ45 interface	RJ45 interface	RJ45 interface is used to connect to the inverter.
		(14)	Battery cover	Clock battery cover	Remove this cover when replacing or installing clock battery, and close the cover after battery is installed
		(15)	USB terminal	Mini USB terminal	Mini USB terminal is used to connect to the USB flash drive through an adapter.

The LCD has different display areas, which displays different contents under different interfaces. The figure below is the main interface of stop state.

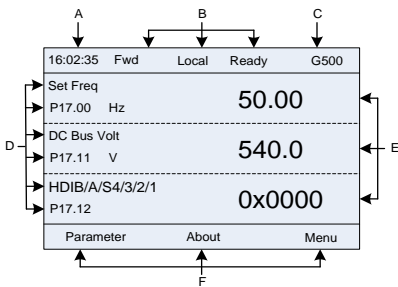



Figure 5-2 Main interface of LCD

Area	Name	Used to
Header A	Real-time display area	Display the real-time; clock battery is not included; the time needs to be reset when powering on the inverter
Header B	Inverter running state display area	Display the running state of the inverter: 1. Display motor rotating direction: "Fwd" – Run forward during operation; "Rev" – Run reversely during operation; "Disrev" – Reverse running is forbidden; 2. Display inverter running command channel: "Local" – Keypad; "Trml" – Terminal; "Remote" - Communication 3. Display current inverter state: "Ready" – The inverter is in stop state (no fault); "Run" – The inverter is in running state; "Jog" – The inverter is in jogging state; "Pre-alarm" – the inverter is under pre-alarm state during running; "Fault" – inverter fault occurred.
Header C	Inverter model display area	Inverter model display: "G500" – current inverter is G500 series inverter
Display D	Parameter names and function codes on the inverter homepage	Display a maximum of three parameter names and function codes on the homepage. The parameters displayed on the homepage can be managed.
Display E	Values of parameters on the inverter homepage	Display the values of parameters on the inverter homepage, which are updated in real time.
Footer F	Corresponding menus of function keys (4), (5) and (6)	Indicate the menus corresponding to function keys (4), (5) and (6). The corresponding menus of function keys (4), (5) and (6) vary with interfaces, and the content displayed in this area varies also.

5.3 Keypad display

The inverter keypad can display the stopped-state parameters, running-state parameters, and fault alarm status.

5.3.1 Displaying stopped-state parameters

When the inverter is in stopped state, the keypad displays stopped-state parameters, and this interface is the main interface during power-up by default. In stopped state, parameters in various states can be displayed. Press  or  to shift the displayed parameter up or down.

16:02:35	Fwd	Local	Ready	G500
Set Freq				50.00
P17.00	Hz			
DC Bus Volt				540.0
P17.11	V			
HDIB/A/S4/3/2/1				0x0000
P17.12				
Parameter	About			Menu

16:02:35	Fwd	Local	Ready	G500
DC Bus Volt				540.0
P17.11	V			
HDIB/A/S4/3/2/1				0x0000
P17.12				
RO2/RO1/HDO/Y1				0x0000
P17.13				
Parameter	About			Menu

Figure 5-3 Stopped-state parameter display 1

Press or to switch between different display styles, including list display style and progress bar display style.

16:02:35	Fwd	Local	Ready	G500
Set Freq				50.00
P17.00	Hz			
DC Bus Volt				540.0
P17.11	V			
HDIB/A/S4/3/2/1				0x0000
P17.12				
Parameter	About			Menu

16:02:35	Fwd	Local	Ready	G500
Set Freq				50.00
Hz				
0.00				630.00
Back				Home

Figure 5-4 Stopped-state parameter display 2

The stopped-state parameter display list is user defined, and each state variable function code can be added to the stopped-state parameter display list as needed. A function code which has been added to the stopped-state parameter display list can also be deleted or shifted.

5.3.2 Displaying running-state parameters

After receiving valid running command, the inverter will enter running state, and the keypad displays running state parameter with RUN indicator on the keypad turning on. In running state, multiple kinds of state parameters can be displayed. Press or to shift up or down.

16:02:35	Fwd	Local	Run	G500
Output Freq				50.00
P17.01	Hz			
Set Freq				50.00
P17.00	Hz			
DC Bus Volt				540.0
P17.11	V			
Parameter	About			Menu

16:02:35	Fwd	Local	Run	G500
Set Freq				50.00
P17.00	Hz			
DC Bus Volt				540.0
P17.11	V			
Output Volt				378
P17.03	V			
Parameter	About			Menu

Figure 5-5 Running parameter display state

Press or to switch between different display styles, including list display style and progress bar display style.

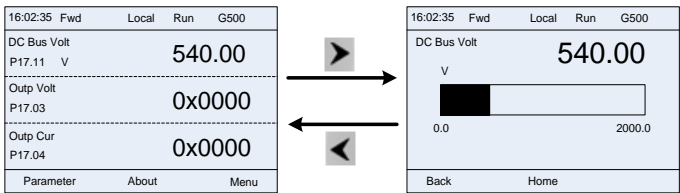

Figure 5-6 Running parameter display state

In running state, multiple kinds of state parameters can be displayed. The running display parameter list is user defined, and each state variable function code can be added to the running display parameter list as needed. A function code which has been added to the running display parameter list can also be deleted or shifted.

5.3.3 Displaying fault information

The inverter enters fault alarm display state once fault signal is detected, and the keypad displays fault code and fault information with the **TRIP** indicator on the keypad turning on. Fault reset operation can be carried out via the **STOP/RST** key, control terminal or communication command.

The fault code will be kept displaying until fault is removed.

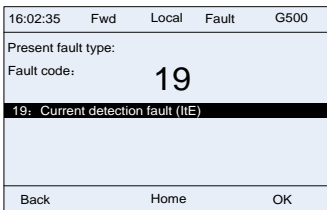

Figure 5-7 Fault alarm display state

5.4 Operating the inverter through the keypad

Various operations can be performed on the inverter, including entering/exiting menus, parameter selection, list modification and parameter addition.

5.4.1 Entering/exiting menus

The keypad displays three main menus at the home interface by default: **Parameter**, **About**, and **Menu**.

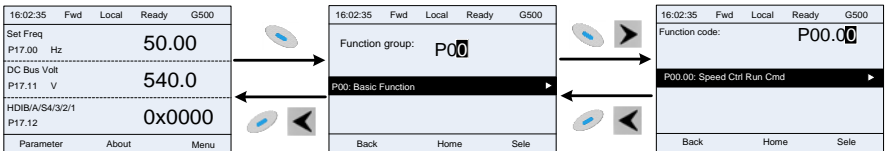

Figure 5-8 Menu entering/exiting diagram 1

The following figure shows how to enter the **Menu** main menu and how to operate under this main menu.

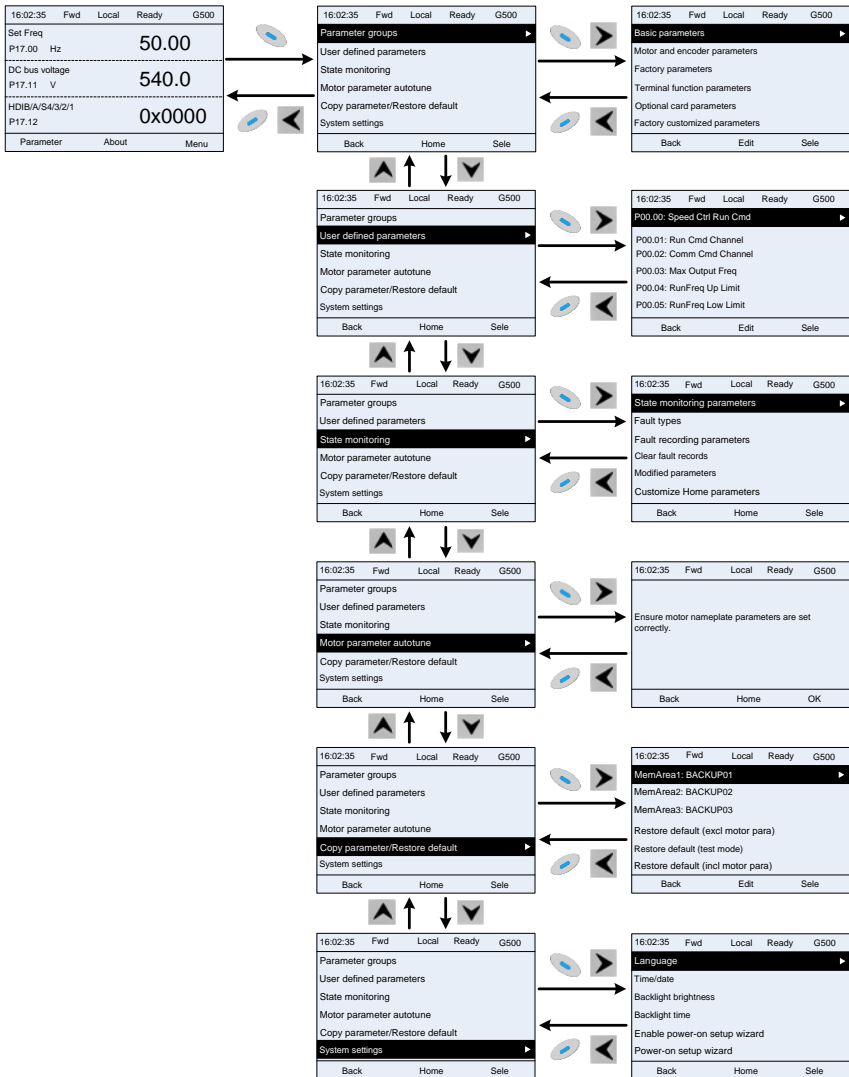

Figure 5-9 Menu entering/exiting diagram 2

The **Menu** interface contains the following submenus by level.

Level 1	Level 2	Level 3	Level 4
Parameter groups	Basic parameters	P00: Basic Function	P00.xx
		P01: Start/stop control	P01.xx
		P03: Motor1 Vector Ctrl	P03.xx
		P04: V/F Control	P04.xx
		P07: HMI	P07.xx
		P08: Enhanced Function	P08.xx
		P09: PID Control	P09.xx
		P10: PLC&Mul-stepSpCtrl	P10.xx
		P11: Protection Param	P11.xx
		P13: SM Ctrl Param	P13.xx
		P14: Serial Comm Func	P14.xx
		P21: Position Ctrl	P21.xx
		P22: Spdl Positioning	P22.xx
		P23: Motor 2 Vector Ctrl	P23.xx
	Motor and encoder parameters	P02: Motor 1 Param	P02.xx
		P12: Motor 2 Param	P12.xx
		P20: Motor 1 Encoder	P20.xx
		P24: Motor 2 Encoder	P24.xx
	Factory parameters	P99: Factory Func	P99.xx
	Terminal function parameters	P05: Input Terminals	P05.xx
		P06: Output Terminals	P06.xx
		P98: AIAO Calibration	P98.xx
	Optional card parameters	P15: Comm Ex-card 1	P15.xx
		P16: Comm Ex-card 2	P16.xx
		P25: Ex I/OCard InpFunc	P25.xx
		P26: Ex I/OCard OutpFunc	P26.xx
		P27: PLC Func	P27.xx
	P28: Master/slave Ctrl	P28.xx	
Factory customized parameters	P90: Tension control speed mode	P90.xx	
	P91: Tension control torque	P91.xx	
	P92: Tension control optimization	P92.xx	
User defined parameters	/	/	Pxx.xx ...

Level 1	Level 2	Level 3	Level 4	
State monitoring	State monitoring parameters	P07: HMI	P07.xx	
		P17: State Viewing Func	P17.xx	
		P18: Cl-IpCtrlStateView	P18.xx	
		P19: Ex-card StateView	P19.xx	
		P93: Tension control state viewing func		P93.xx
	Fault types	/		P07.27: TypeofLatelyFault
				P07.28: Typeof1stLastFault
				P07.29: Typeof2ndLastFault
				P07.30: Typeof3rdLastFault
				P07.31: Typeof4thLastFault
		P07.32: Typeof5thLastFault		
	Fault recording parameters	/		P07.33: RunFreq atLatelyFault
				... P07.xx: xx state of fault xx
	Clear fault records	/		Sure to clear fault records?
Modified parameters	/		Pxx.xx: Modified parameter 1	
			Pxx.xx: Modified parameter 2	
			Pxx.xx: Modified parameter xx	
Customize Home parameters	/	Stopped-state parameters	/	
		Running-state parameters	/	
Motor parameter autotune	/	Ensure motor nameplate parameters are set correctly.	Complete para rotary autotune	
			Complete para static autotune	
			Partial para static autotune	
			Complete para rotary autotune 2 (for AM)	
			Partial para static autotune 2 (for AM)	
Copy parameter/Restore	/	MemArea1: BACKUP01	Upload local func para to keypad	
			Download all func para from	

Level 1	Level 2	Level 3	Level 4
default			keypad
			Download NonMotor func para from keypad
			Download motor func para from keypad
		MemArea2: BACKUP012	Upload local func para to keypad
			Download all func para from keypad
			Download NonMotor func para from keypad
			Download motor func para from keypad
		MemArea3: BACKUP03	Upload local func para to keypad
			Download all func para from keypad
			Download NonMotor func para from keypad
			Download motor func para from keypad
		Restore default (excl motor para)	Sure to restore defaults (excl motor para)?
		Restore default (test mode)	Sure to restore default (test mode)?
		Restore default (incl motor para)	Sure to restore default (incl motor para)?
		System settings	/
Time/date			
Backlight brightness			
Backlight time			
Enable power-on setup wizard			
Power-on setup wizard			
Keypad programming			
Fault time setting			
Control board programming			
Up/Down key sensitivity			

5.4.2 Editing a parameter list

The parameters in the parameter list in stopped state can be added as needed (through the menu of user defined home parameters), and the list can also be edited such as "Move up", "Move down", "Delete from the list", and "Restore default". The edit function is shown in the following.

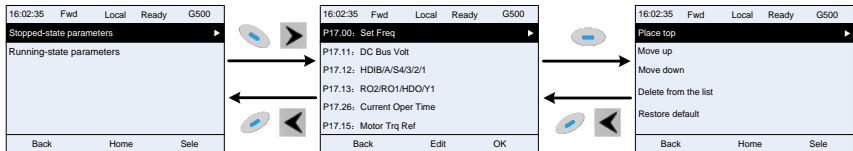

Figure 5-10 List edit diagram 1

Press key to enter edit interface, select the operation needed, and press key, key or key to confirm the edit operation and return to the previous menu (parameter list), the returned list is the list edited. If key or key is pressed in edit interface without selecting edit operation, it will return to the previous menu (parameter list remain unchanged).

Note: For the parameter objects in the list header, move-up operation will be invalid, and the same principle can be applied to the parameter objects in the list footer; after deleting a certain parameter, the parameter objects under it will be moved up automatically.

The items in the parameter list in running state can be added as needed (through the menu of user defined home parameters), and the list can also be edited such as "Move up", "Move down", "Delete from the list", and "Restore default parameters". The edit function is shown in the interface below.

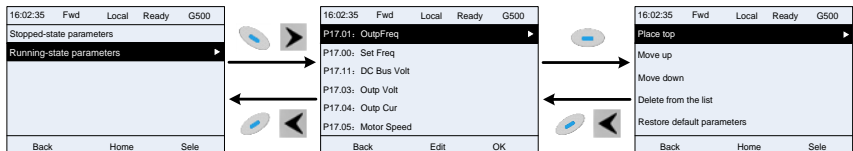

Figure 5-11 List edit diagram 2

The parameters of user defined parameter setting can be added, deleted or adjusted as needed, such as "Move up", "Move down", "Delete from the list", and "Restore default parameters"; the adding function can be set in a certain function code in a function group. The edit function is shown in the figure below.

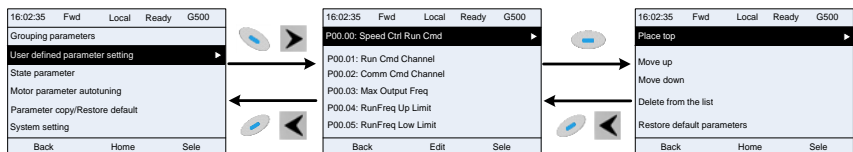

Figure 5-12 List edit diagram 3

5.4.3 Adding parameters to the parameter list displayed in stopped/running state

You can choose **Menu > State monitoring**, choose a submenu, enter a specific function group and then a specific function code to add the parameter to the list of parameters displayed in stopped state or parameters displayed in running state.

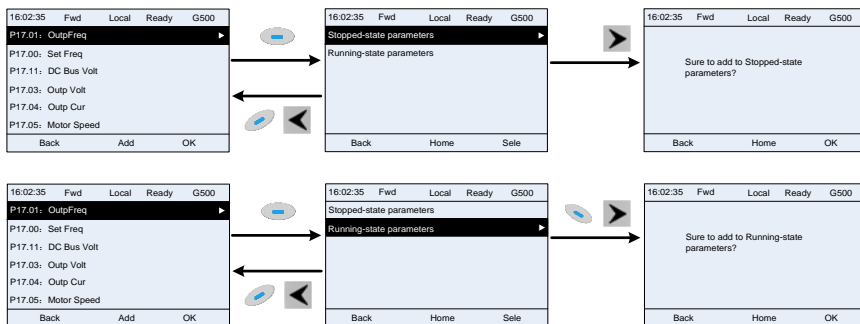

Figure 5-13 Adding parameter diagram 1

After selecting a specific function code, press key to enter the parameter addition interface, and then press , , or key to confirm the addition operation. If this parameter is not included in the list of parameters displayed in stopped state or parameters displayed in running state, the parameter added will be at the end of the list; if the parameter is already in the list of parameters displayed in stopped state or parameters displayed in running state, the addition operation will be invalid. If key or key is pressed without any selection in the addition interface, it will return to the previous menu.

Part of the monitoring parameters in P07 HMI group can be added to the list of parameters displayed in stopped state or parameters displayed in running state. All the parameters in P17, P18 and P19 group can be added to the list of parameters displayed in stopped state or parameters displayed in running state.

Up to 16 monitoring parameters can be added to the list of parameters displayed in stopped state; and up to 32 monitoring parameters can be added to the list of parameters displayed in running state.

5.4.4 Adding parameters to the user defined parameter list

You can choose **Menu > Parameter groups**, choose a submenu, and enter a specific function group and then a specific function code to add the parameter to the user defined parameter list.

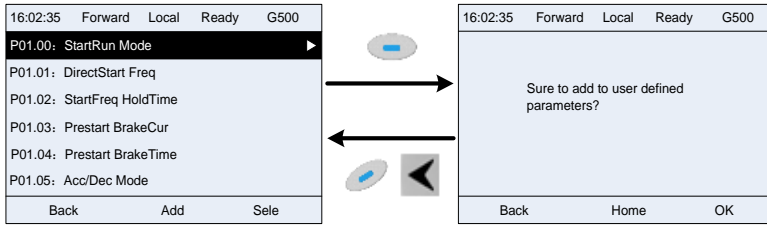

Figure 5-14 Adding parameter diagram 2

Press the key to enter the addition interface, and press key, key or key to confirm the addition operation. If this parameter is not included in the original user defined parameter list, the newly-added parameter will be at the end of the list; if this parameter is already in the list, the addition operation will be invalid. If key or key is pressed without any selection, it will return to the previous menu.

All the function code groups under the parameter group menu can be added to the user defined parameter list. Up to 64 function codes can be added to the user defined parameter list.

5.4.5 Editing user defined parameters

After accessing a specific function code under the **User defined parameters** menu, you can press the key, key or key to enter parameter selection edit interface. After entering the edit interface, the present value will be highlighted. Press key and key to edit current parameter value, and the corresponding parameter item of the value will be highlighted automatically. After parameter selection is done, press key or key to save the selected parameter and return to the previous menu. In parameter selection edit interface, press key to maintain the parameter value and return to the previous menu.

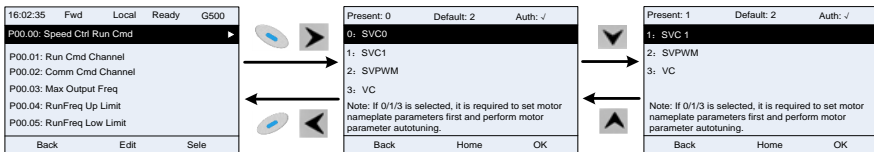

Figure 5-15 Editing user defined parameters

In parameter selection edit interface, the "Auth" field on the top right indicates whether this parameter is editable or not.











"√" indicates the set value of this parameter can be modified under the present state.

"x" indicates the set value of this parameter cannot be modified under the present state.

"Present" indicates the present value.

"Default" indicates the default value of this parameter.

5.4.6 Editing parameters in parameter groups

You can choose **Menu > Parameter groups**, enter a specific function group and then a specific function code, and then press  key,  key or  key to enter the parameter setting interface. After entering the edit interface, set the parameter from the low bit to high bit, and the bit under setting will be highlighted. Press  key or  key to increase or decrease the parameter value (this operation is valid until the parameter value exceeds the max. value or min. value); press  or  to shift the edit bit. After the parameter is set, press  key or  key to save the setting and return to the previous menu; press  to maintain the original parameter value and return to the previous menu.

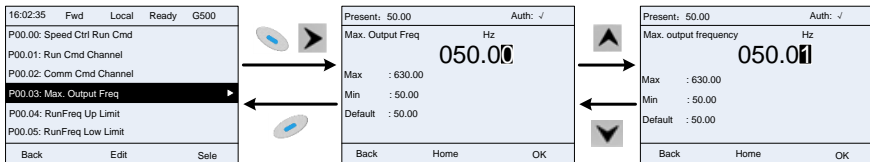

Figure 5-16 Editing parameters in parameter groups

In the parameter edit interface, the "Auth" field on the top right indicates whether this parameter can be modified or not.



" ✓ " indicates the set value of this parameter can be modified under the present state.

" ✗ " indicates the set value of this parameter cannot be modified under the present state.

"Present" indicates the present value.

"Default" indicates the default value of this parameter.

5.4.7 Monitoring states

You can choose **Menu > State monitoring > State monitoring parameter**, enter a specific function group and then a specific function code, and press  key,  key or  key to enter the state monitoring interface. After entering the state monitoring interface, the actual parameter value will be displayed in real time, this value is the actually detected value which cannot be modified.

In the state monitoring interface, you can press  key or  key to return to the previous menu.

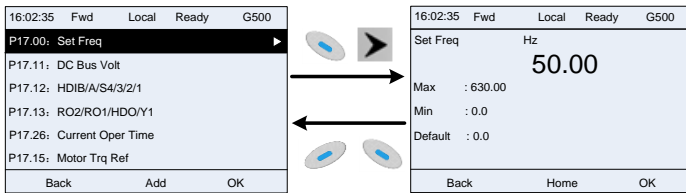

Figure 5-17 State monitoring interface

5.4.8 Autotuning motor parameters

You can choose **Menu > Motor parameter autotune** and press key, key or key to enter motor parameter autotuning interface, however, before entering motor parameter autotuning interface, you must set the motor nameplate parameters correctly. After entering the interface, select motor autotuning type to carry out motor parameter autotuning. In motor parameter autotuning interface, you can press key or key to return to the previous menu.

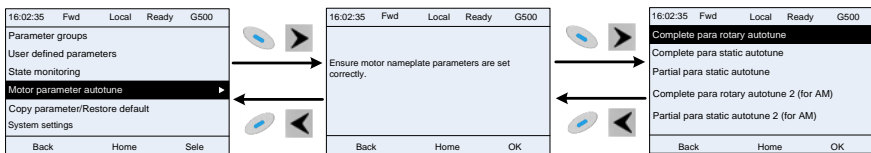

Figure 5-18 Selecting a parameter autotuning type

After selecting a motor autotuning type, enter motor parameter autotuning interface, and press **RUN** key to start motor parameter autotuning. After autotuning is done, a message will pop out indicating autotuning is successful, and then it will return to the main interface of stop. During autotuning, you can press **STOP/RST** key to terminate autotuning; if any fault occur during autotuning, the keypad will display a fault interface.

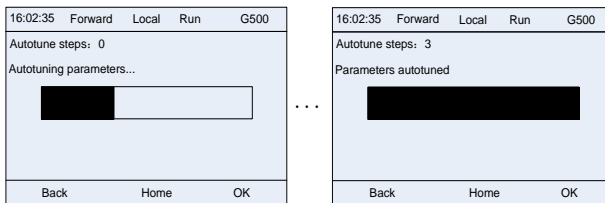

Figure 5-19 Parameter autotuning

5.4.9 Backing up parameters

You can choose **Menu > Copy parameter/Restore default**, and press key, key or key to enter function parameter backup interface and function parameter restoration setting interface to upload/download inverter parameters, or restore inverter parameters to default value. The keypad has three different storage areas for parameter backup, and each storage area can save the

parameters of one inverter, which means the keypad can save parameters of three inverters in total.

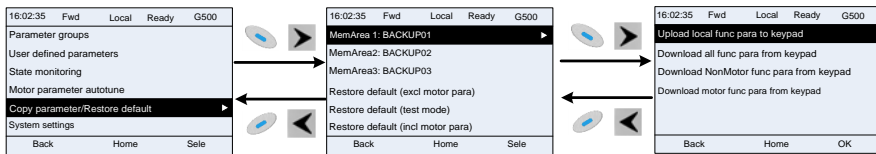

Figure 5-20 Parameter backup

5.4.10 System settings

You can choose **Menu > System settings**, and press key, key or key to enter system setting interface to set the keypad language, time/date, backlight brightness, backlight time and restore parameters.

Note: Clock battery is not included, and the keypad time/date needs to be reset after power off. If time-keeping after power off is needed, you need to purchase the clock batteries separately.

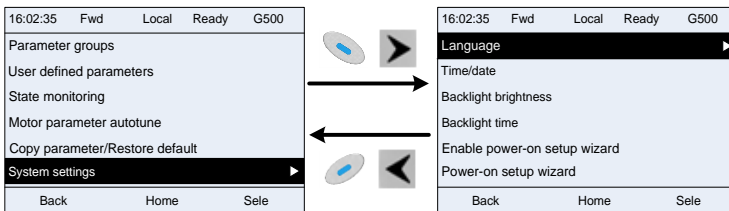
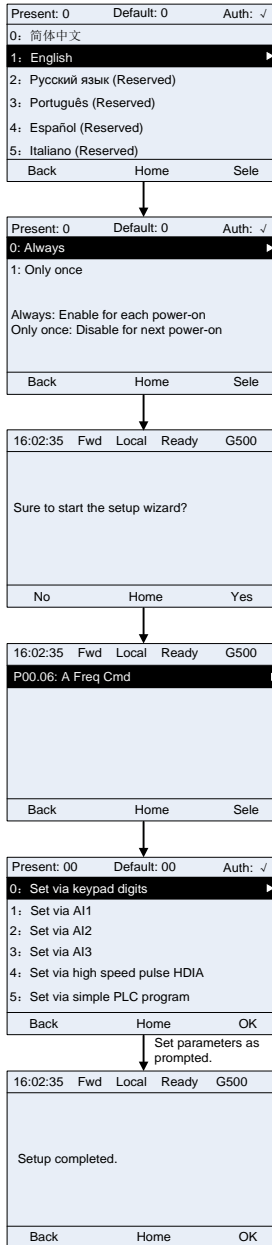

Figure 5-21 System settings

5.4.11 Power-on setup wizard

The keypad supports the power-on setup wizard function, mainly for the first power-on situation, instructing you to enter the setting menu, and gradually implementing basic functions such as basic parameter setting, direction judgment, mode setting and autotuning.

For first power-on, the keypad automatically enters the setup wizard interface. See the following.



If you want to change the wizard settings, you can **Menu > System settings**, and then choose **Enable power-on setup wizard** or **Power-on setup wizard**, and then make changes.

5.5 Basic operation instruction

5.5.1 What this section contains

This section introduces the function modules inside the inverter

	<ul style="list-style-type: none"> • Ensure all the terminals are fixed and tightened firmly. • Ensure the motor matches with the inverter power.
---	---

5.5.2 Common commissioning procedures

The common operation procedures are shown below (take motor 1 as an example).

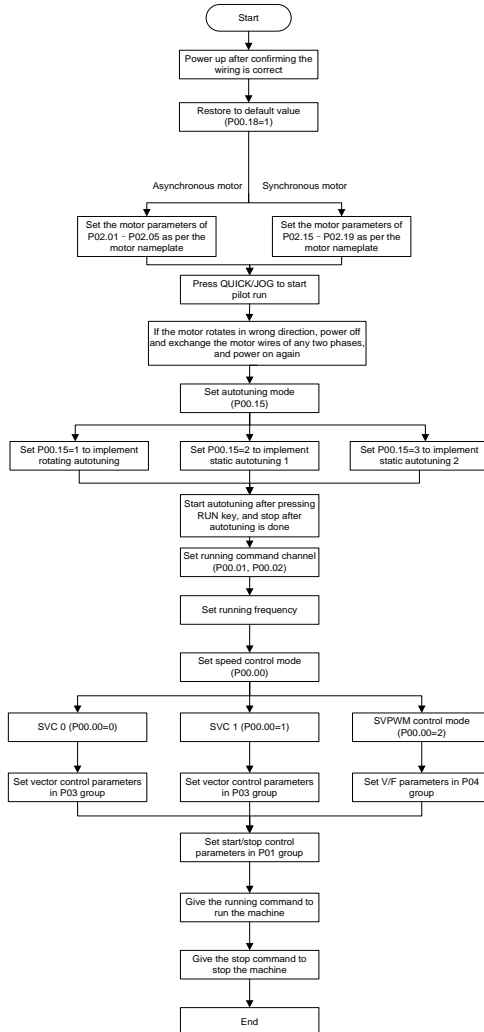

Note: If fault occurred, rule out the fault cause according to "fault tracking".

The running command channel can be set by terminal commands besides P00.01 and P00.02.

Current running command channel P00.01	Multi-function terminal function (36) Command switches to keypad	Multi-function terminal function (37) Command switches to terminal	Multi-function terminal function (38) Command switches to communication
Keypad	/	Terminal	Communication
Terminal	Keypad	/	Communication
Communication	Keypad	Terminal	/

Note: "/" means this multi-function terminal is invalid under current reference channel.

Related parameter list:

Function code	Name	Description	Default value
P00.00	Speed control mode	0:SVC 0 1:SVC 1 2:SVPWM 3:FVC Note: If 0, 1 or 3 is selected, it is required to carry out motor parameter autotuning first.	2
P00.01	Running command channel	0: Keypad 1: Terminal 2: Communication	0
P00.02	Communication running command channel	0:Modbus/Modbus TCP 1:PROFIBUS/CANopen/DeviceNet/ G500XLT 2:Ethernet 3:EtherCAT/PROFINET/EtherNet IP/ G500ETH 4:PLC programmable card 5:Bluetooth card	0
P00.15	Motor parameter autotuning	0: No operation 1: Rotary autotuning; carry out comprehensive motor parameter autotuning; rotary autotuning is used in cases where high control precision is required; 2: Static autotuning 1 (comprehensive autotuning); static autotuning 1 is used in cases where the motor cannot be disconnected from load; 3: Static autotuning 2 (partial autotuning) ;	0

Function code	Name	Description	Default value
		when current motor is motor 1, only P02.06, P02.07 and P02.08 will be autotuned; when current motor is motor 2, only P12.06, P12.07 and P12.08 will be autotuned.	
P00.18	Function parameter restoration	0: No operation 1: Restore to default value 2: Clear fault history Note: After the selected function operations are done, this function code will be restored to 0 automatically. Restoration to default value will clear the user password; this function should be used with caution.	0
P02.00	Type of motor 1	0: Asynchronous motor 1: Synchronous motor	0
P02.01	Rated power of asynchronous motor 1	0.1–3000.0kW (4023HP)	Depend on model
P02.02	Rated frequency of asynchronous motor 1	0.01Hz–P00.03 (Max. output frequency)	60.00Hz
P02.03	Rated speed of asynchronous motor 1	1–36000rpm	Depend on model
P02.04	Rated voltage of asynchronous motor 1	0–1200V	Depend on model
P02.05	Rated current of asynchronous motor 1	0.8–6000.0A	Depend on model
P02.15	Rated power of synchronous motor 1	0.1–3000.0kW (4023HP)	Depend on model
P02.16	Rated frequency of synchronous motor 1	0.01Hz–P00.03 (Max. output frequency)	60.00Hz
P02.17	Number of pole pairs of synchronous motor 1	1–50	2
P02.18	Rated voltage of synchronous motor 1	0–1200V	Depend on model
P02.19	Rated current of synchronous motor 1	0.8–6000.0A	Depend on model
P05.01– P05.06	Function of multi-function digital input terminal (S1–S4, HDIA, HDIB)	36: Command switches to keypad 37: Command switches to terminal 38: Command switches to communication	/

Function code	Name	Description	Default value
P07.01	Function parameter copying	0–4 0: Disabled 1: Upload loc function parameter to keypad 2: Download all function parameter from keypad 3: Download non-motor parameters from keypad 4: Download motor parameters from keypad	0
P07.02	QUICK/JOG key function	Range: 0x00–0x27 Ones: QUICK/JOG key function selection 0: No function 1: Jogging 2: Reserved 3: Switching between forward/reverse rotation 4: Clear UP/DOWN setting 5: Coast to stop 6: Switch running command reference mode by sequence 7: Reserved Tens: Reserved	0x01

5.5.3 Vector control

Asynchronous motors are featured with high order, non-linear, strong coupling and multi-variables, which makes it very difficult to control asynchronous motors during actual application. The vector control theory aims to solve this problem through measuring and controlling the stator current vector of asynchronous motor, and decomposing the stator current vector into existing current (current component which generates internal magnet field) and torque current (current component which generates torque) based on field orientation principle, and then controlling the amplitude value and phase position of these two components (namely, control the stator current vector of motor) to realize decoupling control of existing current and torque current, thus achieving high-performance speed regulation of asynchronous motor.

G500 series inverter carries built-in speed sensor-less vector control algorithm, which can be used to drive the asynchronous motor and permanent-magnet synchronous motor simultaneously. As the core algorithm of vector control is based on accurate motor parameter model, the accuracy of motor parameters will impact the control performance of vector control. It is recommended to input accurate motor parameters and carry out motor parameter autotuning before vector operation.

As vector control algorithm is complicated, users should be cautious of regulation on dedicated function parameters of vector control.

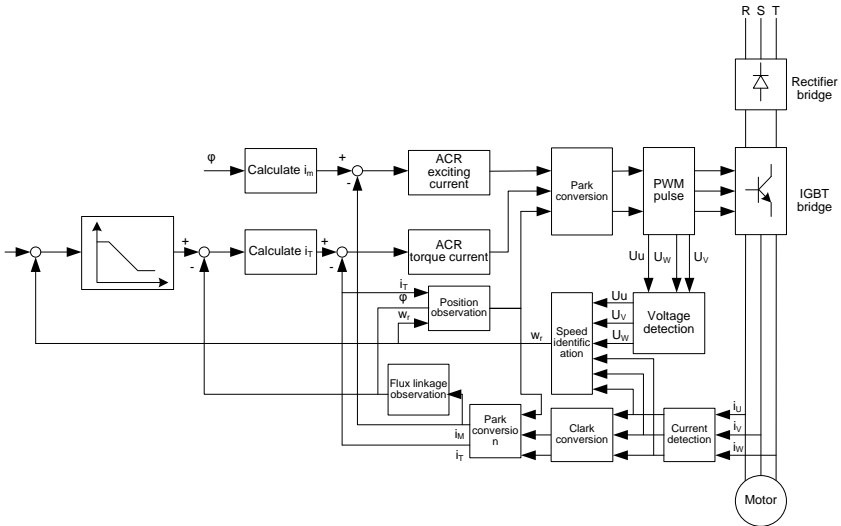

Function code	Name	Description	Default value
P00.00	Speed control mode	0:SVC 0 1:SVC 1 2:SVPWM 3:FVC Note: If 0, 1 or 3 is selected, it is required to carry out motor parameter autotuning first.	2
P00.15	Motor parameter autotuning	0: No operation 1: Rotary autotuning; carry out comprehensive motor parameter autotuning; rotary autotuning is used in cases where high control precision is required; 2: Static autotuning 1 (comprehensive autotuning); static autotuning 1 is used in cases where the motor cannot be disconnected from load; 3: Static autotuning 2 (partial autotuning) ; when current motor is motor 1, only P02.06, P02.07 and P02.08 will be autotuned; when current motor is motor 2, only P12.06, P12.07 and P12.08 will be autotuned.	0
P02.00	Type of motor 1	0: Asynchronous motor 1: Synchronous motor	0

Function code	Name	Description	Default value
P03.00	Speed loop proportional gain 1	0–200.0	20.0
P03.01	Speed loop integral time 1	0.000–10.000s	0.200s
P03.02	Switching low point frequency	0.00Hz–P03.05	5.00Hz
P03.03	Speed loop proportional gain 2	0–200.0	20.0
P03.04	Speed loop integral time 2	0.000–10.000s	0.200s
P03.05	Switching high point frequency	P03.02–P00.03 (Max. output frequency)	10.00Hz
P03.06	Speed loop output filter	0–8 (corresponds to 0–2 ⁸ /10ms)	0
P03.07	Electromotion slip compensation coefficient of vector control	50%–200%	100%
P03.08	Brake slip compensation coefficient of vector control	50%–200%	100%
P03.09	Current loop proportional coefficient P	0–65535	1000
P03.10	Current loop integral coefficient I	0–65535	1000
P03.11	Torque setting mode selection	0–1: Keypad (P03.12) 2: AI1 3: AI2 4: AI3 5: Pulse frequency HDIA 6: Multi-step torque 7: Modbus/Modbus TCP communication 8: PROFIBUS/CANopen/DeviceNet/ G500XLT communication 9: Ethernet communication 10: Pulse frequency HDIB 11: EtherCAT/PROFINET/EtherNet IP/ G500EHT communication 12: Programmable card Note: For these settings, 100% corresponds to the motor rated current.	1
P03.12	Torque set by keypad	-300.0%–300.0% (rated motor current)	50.0%
P03.13	Torque reference filter time	0.000–10.000s	0.010s

Function code	Name	Description	Default value
P03.14	Source of upper limit frequency setting of forward rotation in torque control	0: Keypad (P03.16) 1: AI1 2: AI2 3: AI3 4: Pulse frequency HDIA 5: Multi-step setting 6: Modbus/Modbus TCP communication 7: PROFIBUS/CANopen/DeviceNett/ G500XLT communication 8: Ethernet communication 9: Pulse frequency HDIB 10: EtherCAT/PROFINET/EtherNet IP/ G500EHT communication 11: Programmable card 12: Reserved Note: For these settings, 100% corresponds to the max. frequency.	0
P03.15	Source of upper limit frequency setting of reverse rotation in torque control	0: Keypad (P03.17) 1–11: the same as P03.14	0
P03.16	Keypad limit value of upper limit frequency of forward rotation in torque control	Value range: 0.00 Hz–P00.03 (Max. output frequency)	60.00Hz
P03.17	Keypad limit value of upper limit frequency of reverse rotation in torque control		60.00Hz
P03.18	Source of upper limit setting of the torque when motoring	0: Keypad (P03.20) 1: AI1 2: AI2 3: AI3 4: Pulse frequency HDIA 5: Modbus/Modbus TCP communication 6: PROFIBUS/CANopen/DeviceNett/ G500XLT communication 7: Ethernet communication 8: Pulse frequency HDIB 9: EtherCAT/PROFINET/EtherNet IP/ G500EHT communication 10: Programmable card 11: Reserved Note: For these settings, 100% corresponds	0

Function code	Name	Description	Default value
		to the motor rated current.	
P03.19	Source of upper limit setting of brake torque	0: Keypad (P03.21) 1–10: the same as P03.18	0
P03.20	Set upper limit of the torque when motoring via keypad	0.0–300.0% (rated motor current)	180.0%
P03.21	Set upper limit of brake torque via keypad		180.0%
P03.22	Flux-weakening coefficient in constant power area	0.1–2.0	0.3
P03.23	Min. flux-weakening point in constant power area	10%–100%	20%
P03.24	Max. voltage limit	0.0–120.0%	100.0%
P03.25	Pre-existing time	0.000–10.000s	0.300s
P03.32	Torque control enable	0: Disable 1: Enable	0
P03.35	Control optimization setting	Ones place: Reserved 0: Reserved 1: Reserved Tens place: Reserved 0: Reserved 1: Reserved Hundreds place: ASR integral separation enabling 0: Disabled 1: Enabled Thousands place: Reserved 0: Reserved 1: Reserved Range: 0x0000–0x1111	0x0000
P03.36	ASR differential gain	0.00–10.00s	0.00s
P03.37	High-frequency ACR proportional coefficient	In the closed-loop vector control mode (P00.00=3), when the frequency is lower than the ACR high-frequency switching threshold (P03.39), the ACR PI parameters are P03.09 and P03.10; and when the frequency is higher than the ACR high-frequency switching threshold (P03.39), the ACR PI parameters are P03.37 and P03.38. Setting range of P03.37: 0–20000 Setting range of P03.38: 0–20000	1000
P03.38	High-frequency ACR integral coefficient		1000
P03.39	ACR high-frequency switching threshold		100.0%

Function code	Name	Description	Default value
		Setting range of P03.39: 0.0–100.0% (in relative to the maximum frequency)	
P17.32	Flux linkage	0.0–200.0%	0.0%

5.5.4 SVPWM control mode

G500 inverter also carries built-in SVPWM control function. SVPWM mode can be used in cases where high control precision is not required. In cases where an inverter needs to drive multiple motors, it is also recommended to adopt SVPWM control mode.

G500 inverter provides multiple kinds of V/F curve modes to meet different field needs. Users can select corresponding V/F curve or set the V/F curve as needed.

Suggestions:

1. For the load featuring constant torque, eg, conveyor belt which runs in straight line, as the torque should be constant during the whole running process, it is recommended to adopt straight-type V/F curve.
2. For the load featuring variable torque, eg, fan and water pump, as the relation between its actual torque and speed is squared or cubed, it is recommended to adopt the V/F curve corresponds to power 1.3, 1.7 or 2.0.

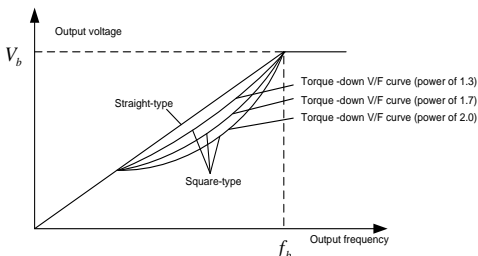

G500 inverter also provides multi-point V/F curve. Users can alter the V/F curve outputted by inverter through setting the voltage and frequency of the three points in the middle. The whole curve consists of five points starting from (0Hz, 0V) and ending in (fundamental motor frequency, rated motor voltage). During setting, it is required that $0 \leq f_1 \leq f_2 \leq f_3 \leq \text{fundamental motor frequency}$, and $0 \leq V_1 \leq V_2 \leq V_3 \leq \text{rated motor voltage}$

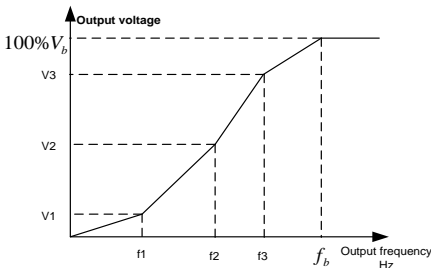

G500 inverter provides dedicated function codes for SVPWM control mode. Users can improve the performance of SVPWM through settings.

1. Torque boost

Torque boost function can effectively compensate for the low-speed torque performance during SVPWM control. Automatic torque boost has been set by default to enable the inverter to adjust the torque boost value based on actual load conditions.

Note:

- (1) Torque boost is effective only under torque boost cut-off frequency;
- (2) If the torque boost is too large, low-frequency vibration or overcurrent may occur to the motor, if such situation occurs, lower the torque boost value.

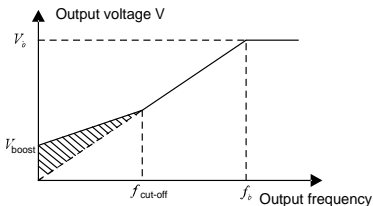

2. Energy-saving run

During actual running, the inverter can search for the max. efficiency point to keep running in the most efficient state to save energy.

Note:

- (1) This function is generally used in light load or no-load cases.
- (2) This function does not fit in cases where load transient is required.

3. V/F slip compensation gain

SVPWM control belongs to open-loop mode, which will cause motor speed to fluctuate when motor load transients. In cases where strict speed requirement is needed, users can set the slip compensation gain to compensate for the speed variation caused by load fluctuation through internal output adjustment of inverter.

The set range of slip compensation gain is 0–200%, in which 100% corresponds to rated slip frequency.

Note: Rated slip frequency= (rated synchronous speed of motor-rated speed of motor) × number of motor pole pairs/60

4. Oscillation control

Motor oscillation often occurs in SVPWM control in large-power drive applications. To solve this problem, G500 series inverter sets two function codes to control the oscillation factor, and users can set the corresponding function code based on the occurrence frequency of oscillation.

Note: The larger the set value, the better the control effect, however, if the set value is too large, it may easily lead to too large inverter output current.

5. Asynchronous motor IF control

Generally, the IF control mode is valid for asynchronous motors. It can be used for a synchronous motor only when the frequency of the synchronous motor is extremely low. Therefore, the IF control described in this manual is only involved with asynchronous motors. IF control is implemented by performing closed-loop control on the total output current of the inverter. The output voltage adapts to the current reference, and open-loop control is separately performed over the frequency of the voltage and current.

Customized V/F curve (V/F separation) function:

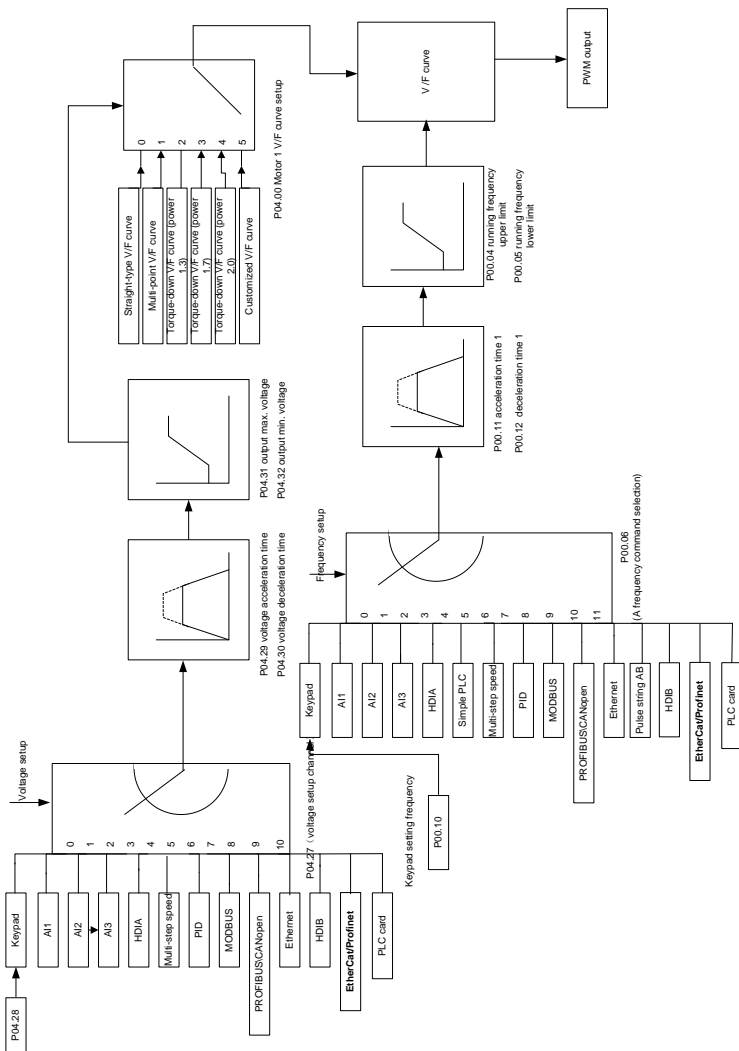

When selecting customized V/F curve function, users can set the reference channels and acceleration/deceleration time of voltage and frequency respectively, which will form a real-time V/F curve through combination.

Note: This kind of V/F curve separation can be applied in various frequency-conversion power sources, however, users should be cautious of parameter setting as improper setting may damage the machine.

Function code	Name	Description	Default value
P00.00	Speed control mode	0:SVC 0 1:SVC 1 2:SV PWM 3:FVC Note: If 0, 1 or 3 is selected, it is required to carry out motor parameter autotuning first.	2
P00.03	Max. output frequency	P00.04–400.00Hz	60.00Hz
P00.04	Upper limit of running frequency	P00.05–P00.03	60.00Hz
P00.05	Lower limit of running frequency	0.00Hz–P00.04	0.00Hz
P00.11	Acceleration time 1	0.0–3600.0s	Depend on model
P00.12	Deceleration time 1	0.0–3600.0s	Depend on model
P02.00	Type of motor 1	0: Asynchronous motor 1: Synchronous motor	0
P02.02	Rated power of asynchronous motor 1	0.01Hz–P00.03 (Max. output frequency)	60.00Hz
P02.04	Rated voltage of asynchronous motor 1	0–1200V	Depend on model
P04.00	V/F curve setting of motor 1	0: Straight-type V/F curve 1: Multi-point V/F curve 2: Torque-down V/F curve (power of 1.3) 3: Torque-down V/F curve (power of 1.7) 4: Torque-down V/F curve (power of 2.0) 5: Customized V/F (V/F separation)	0
P04.01	Torque boost of motor 1	0.0%: (automatic) 0.1%–10.0%	0.0%
P04.02	Motor 1 torque boost cut-off	0.0%–50.0% (rated frequency of motor 1)	20.0%
P04.03	V/F frequency point 1 of motor 1	0.00Hz–P04.05	0.00Hz
P04.04	V/F voltage point 1 of motor 1	0.0%–110.0%	0.0%
P04.05	V/F frequency point 2 of motor 1	P04.03– P04.07	0.00Hz

Function code	Name	Description	Default value
P04.06	V/F voltage point 2 of motor 1	0.0%–110.0%	0.0%
P04.07	V/F frequency point 3 of motor 1	P04.05– P02.02 or P04.05– P02.16	0.00Hz
P04.08	V/F voltage point 3 of motor 1	0.0%–110.0%	0.0%
P04.09	V/F slip compensation gain of motor 1	0.0–200.0%	100.0%
P04.10	Low-frequency oscillation control factor of motor 1	0–100	10
P04.11	High-frequency oscillation control factor of motor 1	0–100	10
P04.12	Oscillation control threshold of motor 1	0.00Hz–P00.03 (Max. output frequency)	30.00Hz
P04.13	V/F curve setting of motor 2	0: Straight V/F curve; 1: Multi-point V/F curve 2: Torque-down V/F curve (power of 1.3) 3: Torque-down V/F curve (power of 1.7) 4: Torque-down V/F curve (power of 2.0) 5: Customize V/F (V/F separation)	0
P04.14	Torque boost of motor 2	0.0%: (automatic) 0.1%–10.0%	0.0%
P04.15	Motor 2 torque boost cut-off	0.0%–50.0% (rated frequency of motor 1)	20.0%
P04.16	V/F frequency point 1 of motor 2	0.00Hz–P04.18	0.00Hz
P04.17	V/F voltage point 1 of motor 2	0.0%–110.0%	0.0%
P04.18	V/F frequency point 2 of motor 2	P04.16– P04.20	0.00Hz
P04.19	V/F voltage point 2 of motor 2	0.0%–110.0%	0.0%
P04.20	V/F frequency point 3 of motor 2	P04.18– P02.02 or P04.18– P02.16	0.00Hz
P04.21	V/F voltage point 3 of	0.0%–110.0%	0.0%

Function code	Name	Description	Default value
	motor 2		
P04.22	V/F slip compensation gain of motor 2	0.0–200.0%	100.0%
P04.23	Low-frequency oscillation control factor of motor 2	0–100	10
P04.24	High-frequency oscillation control factor of motor 2	0–100	10
P04.25	Oscillation control threshold of motor 2	0.00Hz–P00.03 (Max. output frequency)	30.00Hz
P04.26	Energy-saving run	0: No 1: Automatic energy-saving run	0
P04.27	Channel of voltage setting	0: Keypad; output voltage is determined by P04.28 1: AI1 2: AI2 3: AI3 4: HDIA 5: Multi-step 6: PID 7: Modbus/Modbus TCP communication 8: PROFIBUS/CANopen/DeviceNet/ G500XLT communication 9: Ethernet communication 10: HDIB 11: EtherCAT/PROFINET/EtherNet IP/ G500ETH communication 12: PLC card 13: Reserved	0
P04.28	Set voltage value via keypad	0.0%–100.0% (rated motor voltage)	100.0%
P04.29	Voltage increase time	0.0–3600.0s	5.0s
P04.30	Voltage decrease time	0.0–3600.0s	5.0s
P04.31	Output max. voltage	P04.32–100.0% (rated motor voltage)	100.0%
P04.32	Output min. voltage	0.0%–P04.31 (rated motor voltage)	0.0%

Function code	Name	Description	Default value
P04.33	Flux-weakening coefficient in the constant power zone	1.00–1.30	1.00
P04.34	Input current 1 in synchronous motor VF control	When the synchronous motor VF control mode is enabled, this parameter is used to set the reactive current of the motor when the output frequency is lower than the frequency set in P04.36. Setting range: -100.0%→+100.0% (of the rated current of the motor)	20.0%
P04.35	Input current 2 in synchronous motor VF control	When the synchronous motor VF control mode is enabled, this parameter is used to set the reactive current of the motor when the output frequency is higher than the frequency set in P04.36. Setting range: -100.0%→+100.0% (of the rated current of the motor)	10.0%
P04.36	Frequency threshold for pull-in current switching in synchronous motor VF control	When the synchronous motor VF control mode is enabled, this parameter is used to set the frequency threshold for the switching between pull-in current 1 and pull-in current 2. Setting range: 0.0%–200.0% (of the motor rated frequency)	20.0%
P04.37	Reactive current closed-loop proportional coefficient in synchronous motor VF control	When the synchronous motor VF control mode is enabled, this parameter is used to set the proportional coefficient of the reactive current closed-loop control. Setting range: 0–3000	50
P04.38	Reactive current closed-loop integral time in synchronous motor VF control	When the synchronous motor VF control mode is enabled, this parameter is used to set the integral coefficient of the reactive current closed-loop control. Setting range: 0–3000	30
P04.39	Reactive current closed-loop output limit in synchronous motor VF control	When the synchronous motor VF control mode is enabled, this parameter is used to set the output limit of the reactive current closed-loop control. A greater value indicates a higher reactive closed-loop compensation voltage and higher output power of the motor. In general, you do not	8000

Function code	Name	Description	Default value
		need to modify this parameter. Setting range: 0–16000	
P04.40	Enable/disable IF mode for asynchronous motor 1	0: Disabled 1: Enabled	0
P04.41	Current setting in IF mode for asynchronous motor 1	When IF control is adopted for asynchronous motor 1, this parameter is used to set the output current. The value is a percentage in relative to the rated current of the motor. Setting range: 0.0–200.0%	120.0%
P04.42	Proportional coefficient in IF mode for asynchronous motor 1	When IF control is adopted for asynchronous motor 1, this parameter is used to set the proportional coefficient of the output current closed-loop control. Setting range: 0–5000	350
P04.43	Integral coefficient in IF mode for asynchronous motor 1	When IF control is adopted for asynchronous motor 1, this parameter is used to set the integral coefficient of the output current closed-loop control. Setting range: 0–5000	150
P04.44	Frequency threshold for switching off IF mode for asynchronous motor 1	When IF control is adopted for asynchronous motor 1, this parameter is used to set the frequency threshold for switching off the output current closed-loop control. When the frequency is lower than the value of this parameter, the current closed-loop control in the IF control mode is enabled; and when the frequency is higher than that, the current closed-loop control in the IF control mode is disabled. Setting range: 0.00–20.00 Hz	10.00Hz
P04.45	Enable/disable IF mode for asynchronous motor 2	0: Disabled 1: Enabled	0
P04.46	Current setting in IF mode for asynchronous motor 2	When IF control is adopted for asynchronous motor 2, this parameter is used to set the output current. The value is a percentage in relative to the rated current of the motor. Setting range: 0.0–200.0%	120.0%
P04.47	Proportional coefficient in IF mode	When IF control is adopted for asynchronous motor 2, this parameter is used to set the proportional	350

Function code	Name	Description	Default value
	for asynchronous motor 2	coefficient of the output current closed-loop control. Setting range: 0–5000	
P04.48	Integral coefficient in IF mode for asynchronous motor 2	When IF control is adopted for asynchronous motor 2, this parameter is used to set the inetgral coefficient of the output current closed-loop control. Setting range: 0–5000	150
P04.49	Frequency threshold for switching off IF mode for asynchronous motor 2	When IF control is adopted for asynchronous motor 2, this parameter is used to set the frequency threshold for switching off the output current closed-loop control. When the frequency is lower than the value of this parameter, the current closed-loop control in the IF control mode is enabled; and when the frequency is higher than that, the current closed-loop control in the IF control mode is disabled. Setting range: 0.00–20.00 Hz	10.00Hz

5.5.5 Torque control

G500 inverters support torque control and speed control. Speed control mode aims to stabilize the speed to keep the set speed consistent with the actual running speed, meanwhile, the max. load-carrying capacity is restricted by torque limit. Torque control mode aims to stabilize the torque to keep the set torque consistent with the actual output torque, meanwhile, the output frequency is restricted by upper/lower limit.

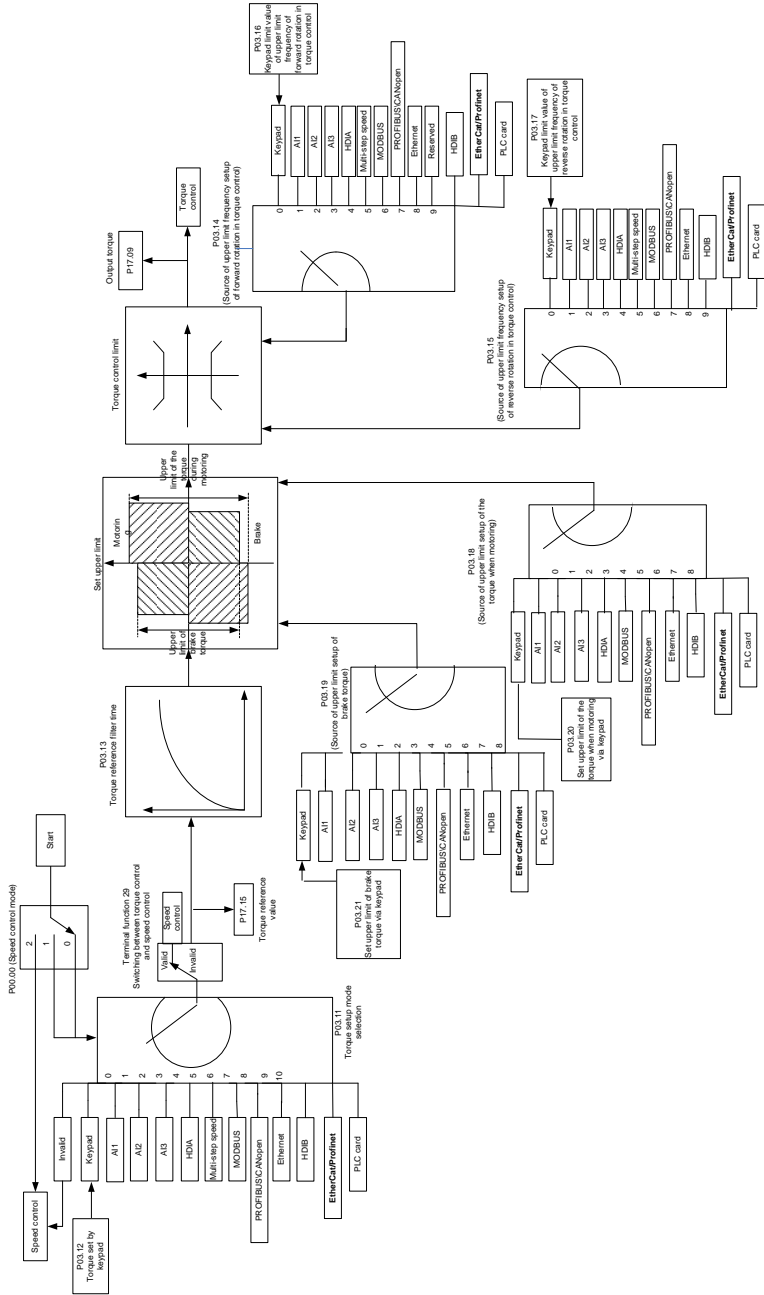



Function code	Name	Description	Default value
P00.00	Speed control mode	0:SVC 0 1:SVC 1 2:SVPWM 3:FVC Note: If 0, 1 or 3 is selected, it is required to carry out motor parameter autotuning first.	2
P03.32	Torque control enable	0:Disable 1:Enable	0
P03.11	Torque setting mode selection	0-1: Keypad (P03.12) 2: AI1 3: AI2 4: AI3 5: Pulse frequency HDIA 6: Multi-step torque 7: Modbus/Modbus TCP communication 8: PROFIBUS/CANopen/DeviceNet/G500XLT communication 9: Ethernet communication 10: Pulse frequency HDIB 11: EtherCAT/PROFINET/EtherNet IP/ G500EHT communication 12: Programmable card Note: For these settings, 100% corresponds to the motor rated current.	0
P03.12	Torque set by keypad	-300.0%–300.0% (rated motor current)	50.0%
P03.13	Torque reference filter time	0.000–10.000s	0.010s
P03.14	Source of upper limit frequency setting of forward rotation in torque control	0: Keypad (P03.16) 1: AI1 2: AI2 3: AI3 4: Pulse frequency HDIA 5: Multi-step setting 6: Modbus/Modbus TCP communication 7: PROFIBUS/CANopen/DeviceNet/G500XLT communication 8: Ethernet communication 9: Pulse frequency HDIB	0

Function code	Name	Description	Default value
		10: EtherCAT/PROFINET/EtherNet IP/G500EHT communication 11: Programmable card 12: Reserved Note: For these settings, 100% corresponds to the max. frequency.	
P03.15	Source of upper limit frequency setting of reverse rotation in torque control	0: Keypad (P03.17) 1: AI1 2: AI2 3: AI3 4: Pulse frequency HDIA 5: Multi-step setting 6: Modbus/Modbus TCP communication 7: PROFIBUS/CANopen/DeviceNet/G500XLT communication 8: Ethernet communication 9: Pulse frequency HDIB 10: EtherCAT/PROFINET/EtherNet IP/G500EHT communication 11: Programmable card 12: Reserved Note: For these settings, 100% corresponds to the max. frequency.	0
P03.16	Keypad limit value of upper limit frequency of forward rotation in torque control	0.00Hz~P00.03 (Max. output frequency)	60.00 Hz
P03.17	Keypad limit value of upper limit frequency of reverse rotation in torque control	0.00Hz~P00.03 (Max. output frequency)	60.00 Hz
P03.18	Source of upper limit setting of the torque during motoring	0: Keypad (P03.20) 1: AI1 2: AI2 3: AI3 4: Pulse frequency HDIA 5: Modbus/Modbus TCP communication	0

Function code	Name	Description	Default value
		6: PROFIBUS/CANopen/DeviceNet/G500XLT communication 7: Ethernet communication 8: Pulse frequency HDIB 9: EtherCAT/PROFINET/EtherNet IP/G500EHT communication 10: Programmable card 11: Reserved Note: For these settings, 100% corresponds to the motor rated current.	
P03.19	Source of upper limit setting of brake torque	0: Keypad (P03.21) 1: AI1 2: AI2 3: AI3 4: Pulse frequency HDIA 5: Modbus/Modbus TCP communication 6: PROFIBUS/CANopen/DeviceNet/G500XLT communication 7: Ethernet communication 8: Pulse frequency HDIB 9: EtherCAT/PROFINET/EtherNet IP/G500EHT communication 10: Programmable card 11: Reserved Note: For these settings, 100% corresponds to the motor rated current.	0
P03.20	Set upper limit of the torque when motoring via keypad	0.0–300.0% (rated motor current)	180.0%
P03.21	Set upper limit of brake torque via keypad	0.0–300.0% (rated motor current)	180.0%
P17.09	Motor output torque	-250.0–250.0%	0.0%
P17.15	Torque reference value	-300.0–300.0% (rated motor current)	0.0%

5.5.6 Motor parameter

	<ul style="list-style-type: none"> Check the safety conditions surrounding the motor and load machineries before autotuning as physical injury may occur due to sudden start of motor during autotuning. Although the motor does not run during static autotuning, the motor is still supplied with power, do not touch the motor during autotuning; otherwise, electric shock may occur.
	<p>If the motor has been connected to load, do not carry out rotary autotuning; otherwise, misact or damage may occur to the inverter. If rotary autotuning is carried out on a motor which has been connected to load, wrong motor parameters and motor misacts may occur. Disconnect the load to carry out autotuning if necessary.</p>

G500 inverter can drive asynchronous motors and synchronous motors, and it supports two sets of motor parameters, which can be switched over by multi-function digital input terminals or communication modes.

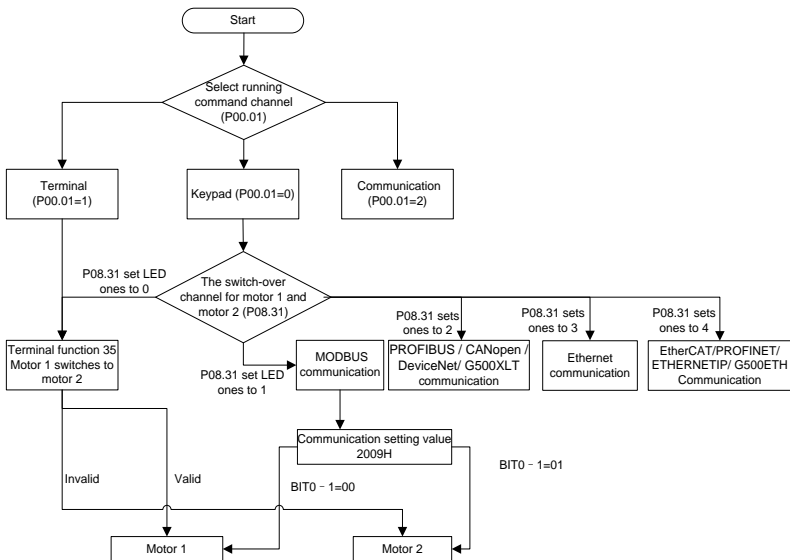

The control performance of the inverter is based on accurate motor model, therefore, users need to carry out motor parameter autotuning before running the motor for the first time (take motor 1 as an example)

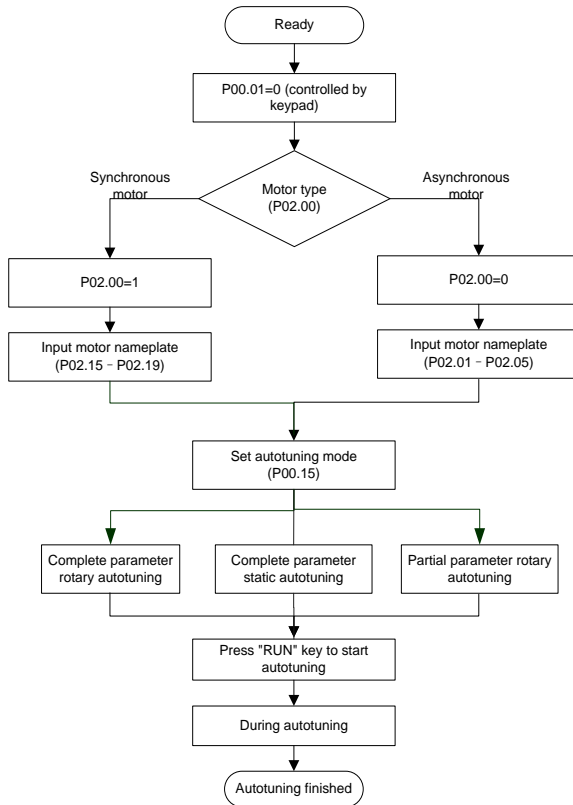
**Note:**

1. Motor parameters must be set correctly according to motor nameplate;
2. If rotary autotuning is selected during motor autotuning, it is a must to disconnect the motor from load to put the motor in static and no-load state, failed to do so may lead to inaccurate autotuned results. At this time, the asynchronous motor can autotune P02.06–P02.10, and synchronous motor can autotune P02.20–P02.23
3. If static autotuning is selected during motor autotuning, there is no need to disconnect the motor from load, as only part of the motor parameters have been autotuned, the control performance may be impacted, under such situation, the asynchronous motor can autotune P02.06–P02.10, while synchronous motor can autotune P02.20–P02.22, P02.23 (counter-emf constant of synchronous motor 1) can be obtained via calculation.
4. Motor autotuning can be carried out on current motor only, if users need to perform autotuning on the other motor, switch the motor over by selecting the switch-over channel of motor 1 and motor 2 by setting the ones of P08.31.

Related parameter list:

Function code	Name	Description	Default value
P00.01	Running command channel	0: Keypad 1: Terminal 2: Communication	0
P00.15	Motor parameter autotuning	0: No operation 1: Rotary autotuning; carry out comprehensive motor parameter autotuning; rotary autotuning is used in cases where high control precision is required; 2: Static autotuning 1 (comprehensive autotuning); static autotuning 1 is used in cases where the motor cannot be disconnected from load; 3: Static autotuning 2 (partial autotuning) ; when current motor is motor 1, only P02.06, P02.07 and P02.08 will be autotuned; when current motor is motor 2, only P12.06, P12.07 and P12.08 will be autotuned.	0
P02.00	Type of motor 1	0: Asynchronous motor 1: Synchronous motor	0
P02.01	Rated power of asynchronous motor 1	0.1–3000.0kW (4023HP)	Depend on model
P02.02	Rated frequency of asynchronous motor 1	0.01Hz–P00.03 (Max. output frequency)	60.00Hz
P02.03	Rated speed of asynchronous motor 1	1–36000rpm	Depend on model
P02.04	Rated voltage of asynchronous motor 1	0–1200V	Depend on model
P02.05	Rated current of asynchronous motor 1	0.8–6000.0A	Depend on model
P02.06	Stator resistance of asynchronous motor 1	0.001–65.535Ω	Depend on model
P02.07	Rotor resistance of asynchronous motor 1	0.001–65.535Ω	Depend on model
P02.08	Leakage inductance of asynchronous motor 1	0.1–6553.5mH	Depend on model
P02.09	Mutual inductance of asynchronous motor 1	0.1–6553.5mH	Depend on model
P02.10	No-load current of	0.1–6553.5A	Depend on

Function code	Name	Description	Default value
	asynchronous motor 1		model
P02.15	Rated power of synchronous motor 1	0.1–3000.0kW (4023HP)	Depend on model
P02.16	Rated frequency of synchronous motor 1	0.01Hz–P00.03 (Max. output frequency)	60.00Hz
P02.17	Number of pole pairs of synchronous motor 1	1–50	2
P02.18	Rated voltage of synchronous motor 1	0–1200V	Depend on model
P02.19	Rated current of synchronous motor 1	0.8–6000.0A	Depend on model
P02.20	Stator resistance of synchronous motor 1	0.001–65.535Ω	Depend on model
P02.21	Direct-axis inductance of synchronous motor 1	0.01–655.35mH	Depend on model
P02.22	Quadrature-axis inductance of synchronous motor 1	0.01–655.35mH	Depend on model
P02.23	Counter-emf constant of synchronous motor 1	0–10000	300
P05.01– P05.06	Function of multi-function digital input terminal (S1–S4, HDIA, HDIB)	35: Motor 1 switches to motor 2	/
P08.31	Switching between motor 1 and motor 2	0x00–0x14 Ones: Switch-over channel 0: Switch-over by terminal 1: Switch-over by Modbus/Modbus TCP communication 2: Switch-over by PROFIBUS / CANopen /DeviceNet/ G500XLT 3: Switch-over by Ethernet communication 4: Switch-over by EtherCAT/PROFINET/ EtherNet IP/G500ETH communication Tens: Motor switch-over during running 0: Disable switch-over during running 1: Enable switch-over during running	00
P12.00	Type of motor 2	0: Asynchronous motor 1: Synchronous motor	0
P12.01	Rated power of asynchronous motor 2	0.1–3000.0kW (4023HP)	Depend on model
P12.02	Rated frequency of asynchronous motor 2	0.01Hz–P00.03 (Max. output frequency)	60.00Hz
P12.03	Rated speed of	1–36000rpm	Depend on

Function code	Name	Description	Default value
	asynchronous motor 2		model
P12.04	Rated voltage of asynchronous motor 2	0–1200V	
P12.05	Rated current of asynchronous motor 2	0.8–6000.0A	
P12.06	Stator resistance of asynchronous motor 2	0.001–65.535Ω	
P12.07	Rotor resistance of asynchronous motor 2	0.001–65.535Ω	
P12.08	Leakage inductance of asynchronous motor 2	0.1–6553.5mH	
P12.09	Mutual inductance of asynchronous motor 2	0.1–6553.5mH	
P12.10	No-load current of asynchronous motor 2	0.1–6553.5A	
P12.15	Rated power of synchronous motor 2	0.1–3000.0kW (4023HP)	
P12.16	Rated frequency of synchronous motor 2	0.01Hz–P00.03 (Max. output frequency)	
P12.17	Number of pole pairs of synchronous motor 2	1–50	2
P12.18	Rated voltage of synchronous motor 2	0–1200V	Depend on model
P12.19	Rated current of synchronous motor 2	0.8–6000.0A	Depend on model
P12.20	Stator resistance of synchronous motor 2	0.001–65.535Ω	Depend on model
P12.21	Direct-axis inductance of synchronous motor 2	0.01–655.35mH	Depend on model
P12.22	Quadrature-axis inductance of synchronous motor 2	0.01–655.35mH	Depend on model
P12.23	Counter-emf constant of synchronous motor 2	0–10000	300

5.5.7 Start/stop control

The start/stop control of the inverter is divided into three states: start after running command at power-up; start after restart-at-power-cut function is effective; start after automatic fault reset. Descriptions for these three start/stop control states are presented below.

There are three start modes for the inverter, which are start at starting frequency, start after DC brake, and start after speed-tracking. Users can select the proper start mode based on field conditions.

For large-inertia load, especially in cases where reversal may occur, users can choose to start after

DC brake or start after speed-racking.

Note: It is recommended to drive synchronous motors in direct start mode.

1. Logic diagram for running command after power-up

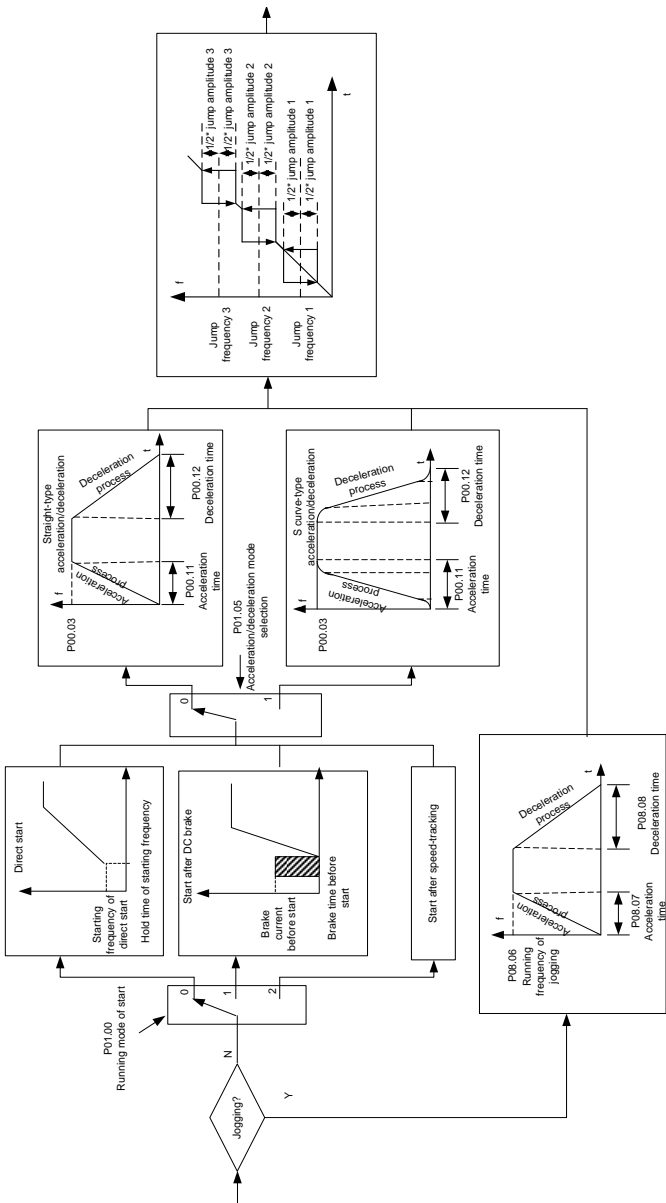

2. Logic diagram for restart after power-cut

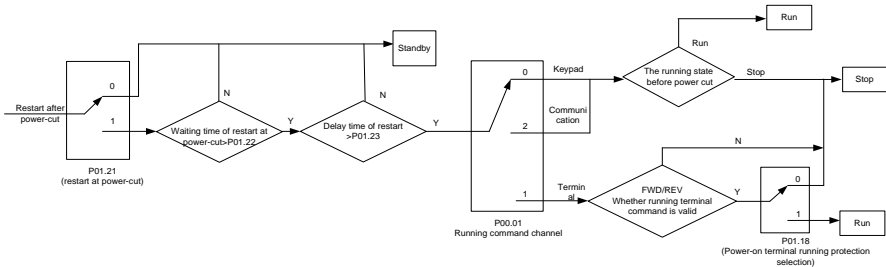

3. Logic diagram for restart after automatic fault reset

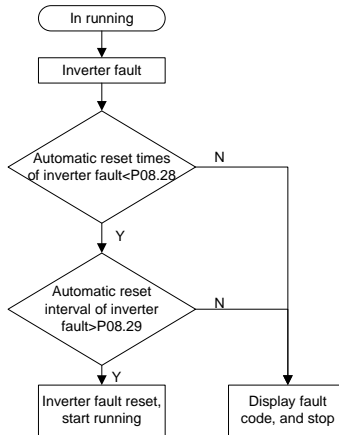

Related parameter list:

Function code	Name	Description	Default value
P00.01	Running command channel	0: Keypad 1: Terminal 2: Communication	0
P00.11	Acceleration time 1	0.0–3600.0s	Depend on model
P00.12	Deceleration time 1	0.0–3600.0s	Depend on model
P01.00	Running mode of start	0: Direct start 1: Start after DC brake 2: Start after speed-track	0
P01.01	Starting frequency of direct start	0.00–50.00Hz	0.50Hz

Function code	Name	Description	Default value
P01.02	Hold time of starting frequency	0.0–50.0s	0.0s
P01.03	DC brake current before start	0.0–100.0%	0.0%
P01.04	DC brake time before start	0.00–50.00s	0.00s
P01.05	Acceleration/deceleration mode	0: Straight line 1: S curve Note: If mode 1 is selected, it is required to set P01.07, P01.27 and P01.08 accordingly	0
P01.08	Stop mode	0: Decelerate to stop 1: Coast to stop	0
P01.09	Starting frequency of DC brake after stop	0.00Hz–P00.03 (Max. output frequency)	0.00Hz
P01.10	Waiting time of DC brake after stop	0.00–50.00s	0.00s
P01.11	DC brake current of stop	0.0–100.0%	0.0%
P01.12	DC brake time of stop	0.00–50.00s	0.00s
P01.13	Deadzone time of forward/reverse rotation	0.0–3600.0s	0.0s
P01.14	Forward/reverse rotation switch-over mode	0: switchover after zero frequency 1: switchover after starting frequency 2: switchover after passing stop speed and delay	1
P01.15	Stop speed	0.00–100.00Hz	0.50 Hz
P01.16	Stop speed detection mode	0: Set value of speed (the only detection mode valid in SVPWM mode) 1: Detection value of speed	1
P01.18	Power-on terminal running protection selection	0: Terminal running command is invalid at power up 1: Terminal running command is valid at power up	0
P01.19	Action selection when the running frequency is below lower limit (lower limit should be larger than 0)	Ones place: Action selection 0: Run in lower limit of the frequency 1: Stop 2: Sleep Tens place: Stop mode 0: Coast to stop 1: Decelerate to stop	0x00

Function code	Name	Description	Default value
P01.20	Wake-up-from-sleep delay	0.0–3600.0s (valid when the ones place of P01.19 is 2)	0.0s
P01.21	Restart after power cut	0: Restart is disabled 1: Restart is enabled	0
P01.22	Waiting time of restart after power cut	0.0–3600.0s (valid when P01.21 is 1)	1.0s
P01.23	Start delay	0.0–60.0s	0.0s
P01.24	Stop speed delay	0.0–100.0s	0.0s
P01.25	Open-loop 0Hz output selection	0: No voltage output 1: With voltage output 2: Output as per DC brake current of stop	0
P01.26	Deceleration time of emergency-stop	0.0–60.0s	2.0s
P01.27	Time of starting section of deceleration S curve	0.0–50.0s	0.1s
P01.28	Time of ending section of deceleration S curve	0.0–50.0s	0.1s
P01.29	Short-circuit brake current	0.0–150.0% (rated inverter current)	0.0%
P01.30	Hold time of short-circuit brake at startup	0.00–50.00s	0.00s
P01.31	Hold time of short-circuit brake at stop	0.00–50.00s	0.00s
P05.01– P05.06	Digital input function selection	1: Forward running 2: Reverse running 4: Forward jogging 5: Reverse jogging 6: Coast to stop 7: Fault reset 8: Running pause 21: Acceleration/deceleration time selection 1 22: Acceleration/deceleration time selection 2 30: Acceleration/deceleration disabled	/
P08.06	Running frequency of jog	0.00Hz–P00.03 (Max. output frequency)	5.00Hz

Function code	Name	Description	Default value
P08.07	Acceleration time at jogging	0.0–3600.0s	Depend on model
P08.08	Deceleration time at jogging	0.0–3600.0s	Depend on model
P08.00	Acceleration time 2	0.0–3600.0s	Depend on model
P08.01	Declaration time 2	0.0–3600.0s	Depend on model
P08.02	Acceleration time 3	0.0–3600.0s	Depend on model
P08.03	Declaration time 3	0.0–3600.0s	Depend on model
P08.04	Acceleration time 4	0.0–3600.0s	Depend on model
P08.05	Declaration time 4	0.0–3600.0s	Depend on model
P08.19	Switching frequency of acceleration/deceleration time	0.00–P00.03 (Max. output frequency) 0.00Hz: No switch over If the running frequency is larger than P08.19, switch to acceleration /deceleration time 2	0
P08.21	Reference frequency of acceleration/deceleration time	0: Max. output frequency 1: Set frequency 2: 100Hz Note: Valid for straight-line acceleration/deceleration only	0
P08.28	Automatic fault reset times	0–10	0
P08.29	Automatic fault reset time interval	0.1–3600.0s	1.0s

5.5.8 Frequency setting

G500 series inverter supports multiple kinds of frequency reference modes, which can be categorized into two types: main reference channel and auxiliary reference channel.

There are two main reference channels, namely frequency reference channel A and frequency reference channel B. These two channels support simple arithmetical operation between each other, and they can be switched dynamically by setting multi-function terminals.

There is one input mode for auxiliary reference channel, namely terminal UP/DOWN switch input. By setting function codes, users can enable the corresponding reference mode and the impact made on the inverter frequency reference by this reference mode.

The actual reference of inverter is comprised of the main reference channel and auxiliary reference channel.

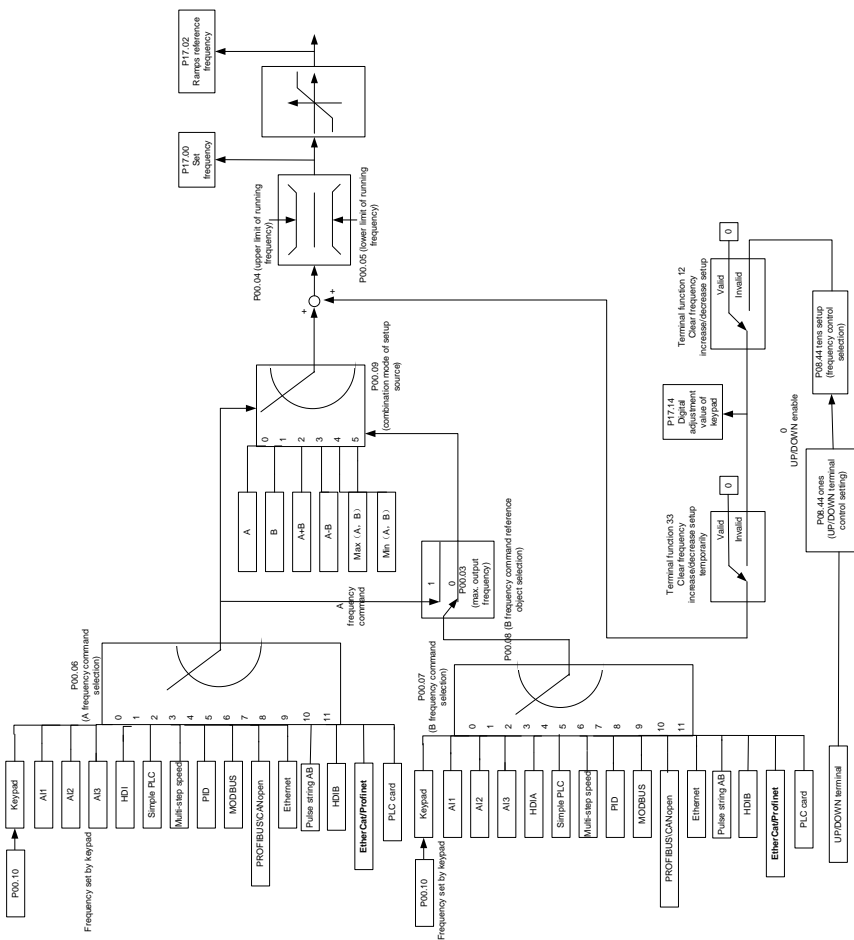

G500 inverter supports switch-over between different reference channels, and the rules for channel switch-over are shown below.

Present reference channel P00.09	Multi-function terminal function 13 Channel A switches to channel B	Multi-function terminal function 14 Combination setting mode switches to channel A	Multi-function terminal function 15 Combination setting mode switches to channel B
A	B	/	/
B	A	/	/
A+B	/	A	B
A-B	/	A	B
Max (A, B)	/	A	B
Min (A, B)	/	A	B

Note: "/" indicates this multi-function terminal is invalid under present reference channel.

When setting the auxiliary frequency inside the inverter via multi-function terminal UP (10) and DOWN (11), users can increase/decrease the frequency quickly by setting P08.45 (UP terminal frequency incremental change rate) and P08.46 (DOWN terminal frequency decremental change rate).

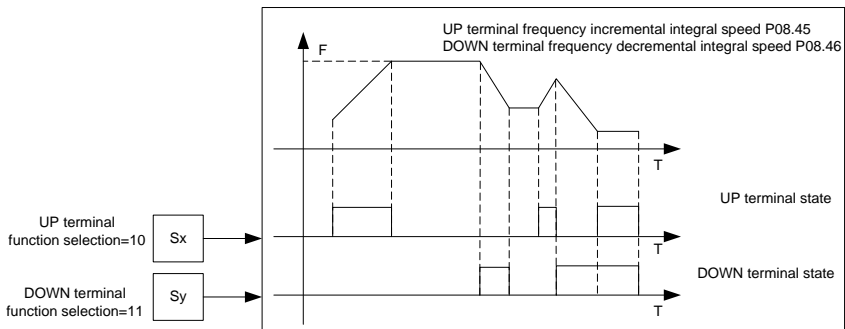

Related parameter list:

Function code	Name	Description	Default value
P00.03	Max. output frequency	P00.04–400.00Hz	60.00Hz
P00.04	Upper limit of running frequency	P00.05–P00.03	60.00Hz
P00.05	Lower limit of running frequency	0.00Hz–P00.04	0.00Hz
P00.06	A frequency command selection	0: Set via keypad 1: Set via AI1	0
P00.07	B frequency command selection	2: Set via AI2 3: Set via AI3	15

Function code	Name	Description	Default value
		4: Set via high speed pulse HDIA 5: Set via simple PLC program 6: Set via multi-step speed running 7: Set via PID control 8: Set via Modbus/Modbus TCP communication 9: Set via PROFIBUS / CANopen / DeviceNet/ G500XLT communication 10: Set via Ethernet communication 11: Set via high speed pulse HDIB 12: Set via pulse string AB 13: Set via EtherCAT/PROFINET/ EthernetIP/G500ETH communication 14: Set via PLC card 15: Reserved	
P00.08	Reference object of B frequency command	0: Max. output frequency 1: A frequency command	0
P00.09	Combination mode of setting source	0: A 1: B 2: (A+B) 3: (A-B) 4: Max (A, B) 5: Min (A, B)	0
P05.01– P05.06	Function of multi-function digital input terminal (S1–S4, HDIA, HDIB)	10: Frequency increase (UP) 11: Frequency decrease (DOWN) 12: Clear frequency increase/decrease setting 13: Switch-over between setting sources A and B 14: Switch-over between combination setting mode and setting source A 15: Switch-over between combination setting mode and setting source B	/
P08.42	Reserved	/	/
P08.43	Reserved	/	/
P08.44	UP/DOWN terminal control	0x000–0x221 Ones: Frequency enabling selection 0: Setting through the UP/DOWN terminal is valid	0x000

Function code	Name	Description	Default value
		1: Setting through the UP/DOWN terminal is invalid Tens: Frequency control selection 0: Valid only when P00.06=0 or P00.07=0 1: Valid for all frequency modes 2: Invalid for multi-step speed when multi-step speed takes priority Hundreds: Action selection at stop 0: Valid 1: Valid during running, clear after stop 2: Valid during running, clear after receiving stop command	
P08.45	UP terminal frequency incremental change rate	0.01–50.00 Hz/s	0.50 Hz/s
P08.46	DOWN terminal frequency decremental change rate	0.01–50.00 Hz/s	0.50 Hz/s
P17.00	Set frequency	0.00Hz–P00.03 (Max. output frequency)	0.00Hz
P17.02	Ramps reference frequency	0.00Hz–P00.03 (Max. output frequency)	0.00Hz
P17.14	Digital adjustment value	0.00Hz–P00.03	0.00Hz

5.5.9 Analog input

G500 series inverter carries two analog input terminals (AI1 is 0–10V/0–20mA (voltage input or current input can be set by P05.50); AI2 is -10–10V) and two high-speed pulse input terminals. Each input can be filtered separately, and the corresponding reference curve can be set by adjusting the reference corresponds to the max. value and min. value.

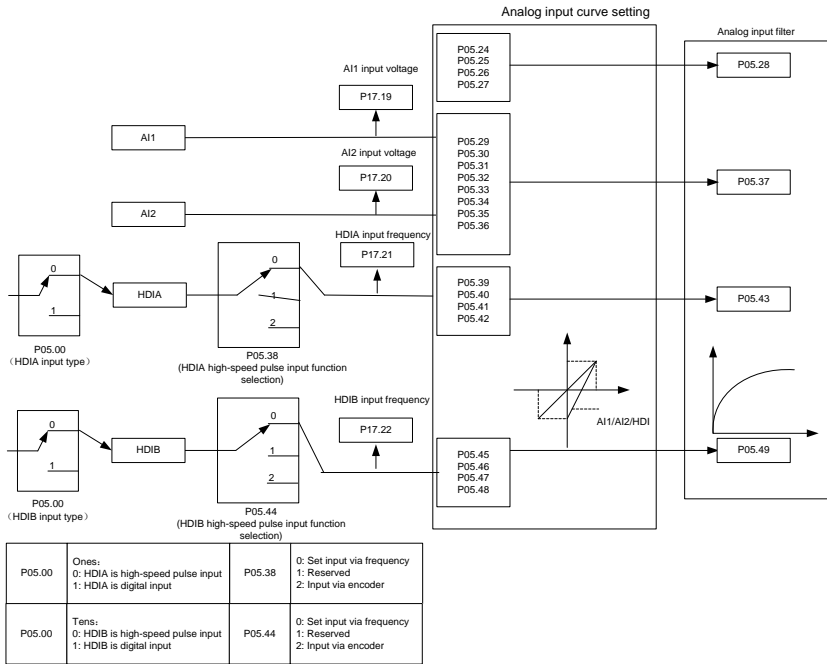

Related parameter list:

Function code	Name	Description	Default value
P05.00	HDI input type	0x00–0x11 Ones: HDIA input type 0: HDIA is high-speed pulse input 1: HDIA is digital input Tens: HDIB input type 0: HDIB is high-speed pulse input 1: HDIB is digital input	0x00
P05.24	Lower limit value of AI1	0.00V–P05.26	0.00V
P05.25	Corresponding setting of lower limit of AI1	-100.0%–100.0%	0.0%
P05.26	Upper limit value of AI1	P05.24–10.00V	10.00V
P05.27	Corresponding setting of upper limit of AI1	-100.0%–100.0%	100.0%
P05.28	Input filter time of AI1	0.000s–10.000s	0.100s
P05.29	Lower limit value of AI2	-10.00V–P05.31	-10.00V

Function code	Name	Description	Default value
P05.30	Corresponding setting of lower limit of AI2	-100.0%–100.0%	-100.0%
P05.31	Intermediate value 1 of AI2	P05.29–P05.33	0.00V
P05.32	Corresponding setting of intermediate value 1 of AI2	-100.0%–100.0%	0.0%
P05.33	Intermediate value 2 of AI2	P05.31–P05.35	0.00V
P05.34	Corresponding setting of intermediate value 2 of AI2	-100.0%–100.0%	0.0%
P05.35	Upper limit value of AI2	P05.33–10.00V	10.00V
P05.36	Corresponding setting of upper limit of AI2	-100.0%–100.0%	100.0%
P05.37	Input filter time of AI2	0.000s–10.000s	0.100s
P05.38	HDIA high-speed pulse input function	0: Set input via frequency 1: Reserved 2: Input via encoder, used in combination with HDIB	0
P05.39	Lower limit frequency of HDIA	0.000 KHz – P05.41	0.000KHz
P05.40	Corresponding setting of lower limit frequency of HDIA	-100.0%–100.0%	0.0%
P05.41	Upper limit frequency of HDIA	P05.39 –50.000KHz	50.000KHz
P05.42	Corresponding setting of upper limit frequency of HDIA	-100.0%–100.0%	100.0%
P05.43	HDIA frequency input filter time	0.000s–10.000s	0.030s
P05.44	HDIB high-speed pulse input function selection	0: Set input via frequency 1: Reserved 2: Input via encoder, used in combination with HDIA	0
P05.45	Lower limit frequency of HDIB	0.000 KHz – P05.47	0.000KHz
P05.46	Corresponding setting of lower limit frequency of HDIB	-100.0%–100.0%	0.0%
P05.47	Upper limit frequency of HDIB	P05.45 –50.000KHz	50.000KHz

Function code	Name	Description	Default value
P05.48	Corresponding setting of upper limit frequency of HDIB	-100.0%–100.0%	100.0%
P05.49	HDIB frequency input filter time	0.000s–10.000s	0.030s
P05.50	AI1 input signal type	0–1 0: Voltage type 1: Current type	0

5.5.10 Analog output

G500 series inverter carries one analog output terminal (0–10V/0–20mA) and one high-speed pulse output terminal. Analog output signals can be filtered separately, and the proportional relation can be adjusted by setting the max. value, min. value, and the percentage of their corresponding output. An analog output signal can output motor speed, output frequency, output current, motor torque and motor power at a certain proportion.

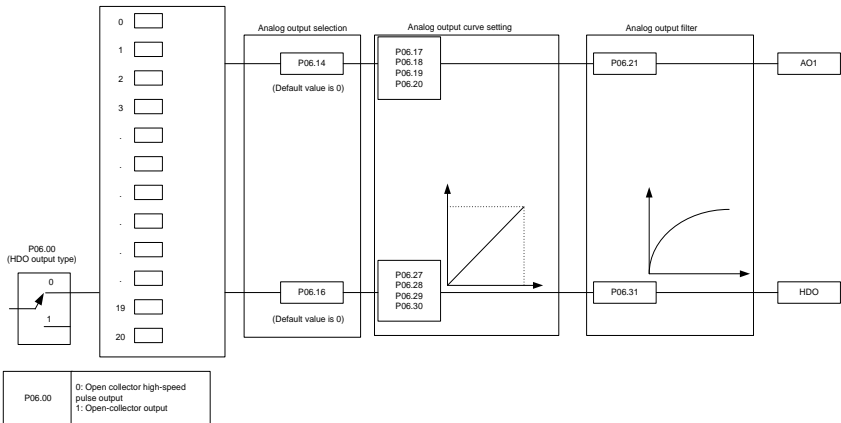

Instructions for output:

Set value	Function	Description
0	Running frequency	0–Max. output frequency
1	Set frequency	0–Max. output frequency
2	Ramps reference frequency	0–Max. output frequency
3	Running speed	0–Synchronous speed corresponding to Max. output frequency
4	Output current (relative to	0–Two times of rated current of inverter

Set value	Function	Description
	inverter)	
5	Output current (relative to motor)	0–Two times of rated current of motor
6	Output voltage	0–1.5 times of rated voltage of inverter
7	Output power	0–Two times of rated power
8	Set torque value	0–Two times of rated current of motor
9	Output torque	0–Two times of rated current of motor
10	AI1 input value	0–10V/0–20mA
11	AI2 input value	-10V–10V
12	AI3 input value	0–10V/0–20mA
13	Input value of high-speed pulse HDIA	0.00–50.00kHz
14	Set value 1 of Modbus/Modbus TCP communication	-1000–1000, 1000 corresponds to 100.0%
15	Set value 2 of Modbus/Modbus TCP communication	-1000–1000, 1000 corresponds to 100.0%
16	Set value 1 of PROFIBUS/CANopen communication	-1000–1000, 1000 corresponds to 100.0%
17	Set value 2 of PROFIBUS/CANopen communication	-1000–1000, 1000 corresponds to 100.0%
18	Set value 1 of Ethernet communication	-1000–1000, 1000 corresponds to 100.0%
19	Set value 2 of Ethernet communication	-1000–1000, 1000 corresponds to 100.0%
20	Input value of high-speed pulse HDIB	0.00–50.00kHz
21	Reserved	
22	Torque current (bipolar, 100% corresponds to 10V)	0–Two times of rated current of motor
23	Existing current (100% corresponds to 10V)	0–One times of rated current of motor
24	Set frequency (bipolar)	0–Max. output frequency
25	Ramps reference frequency (bipolar)	0–Max. output frequency
26	Running speed (bipolar)	0–Max. output frequency

Set value	Function	Description
27	Set value 2 of EtherCAT/PROFINET/EtherNet IP/ G500ETH communication	-1000–1000, 1000 corresponds to 100.0%
28	AO1 from the programmable card	0–1000
29	AO2 from the programmable card	0–1000
30	Running speed	0–Two times of rated synchronous speed of motor
31	Output torque (bipolar)	0–Twice the motor rated torque. A negative value corresponds to 0.0% by default.
32	AI/AO temperature detection output	AO value of AI/AO temperature detection

Related parameter list:

Function code	Name	Description	Default value
P06.00	HDO output type	0: Open collector high-speed pulse output 1: Open collector output	0
P06.14	AO1 output selection	0: Running frequency	0
P06.15	Reserved variable	1: Set frequency	0
P06.16	HDO high-speed pulse output	2: Ramps reference frequency 3: Running speed 4: Output current (relative to inverter) 5: Output current (relative to motor) 6: Output voltage 7: Output power 8: Set torque value 9: Output torque 10: Analog AI1 input value 11: Analog AI2 input value 12: Analog AI3 input value 13: Input value of high-speed pulse HDIA 14: Set value 1 of Modbus/Modbus TCP communication 15: Set value 2 of Modbus/Modbus TCP communication 16: Set value 1 of PROFIBUS/CANopen/DeviceNet/G500XLT communication	0

Function code	Name	Description	Default value
		17: Set value 2 of PROFIBUS/CANopen/DeviceNet/G500XLT communication 18: Set value 1 of Ethernet communication 19: Set value 2 of Ethernet communication 20: Input value of high-speed pulse HDIB 21: Set value 1 of EtherCAT/PROFINET/EtherNet IP/G500ETH communication 22: Torque current (bipolar, 100% corresponds to 10V) 23: Existing current (100% corresponds to 10V) 24: Set frequency (bipolar) 25: Ramps reference frequency (bipolar) 26: Running speed (bipolar) 27: Set value 2 of EtherCAT/PROFINET/EtherNet IP/G500ETH communication 28: AO1 from the programmable card (0–1000) 29: AO2 from the programmable card (0–1000) 30: Running speed (100% corresponds to twice the motor rated synchronous speed) 31: Output torque (Actual value, 100% corresponds to twice the motor rated torque) 32: AI/AO temperature detection output 33–63: Reserved	
P06.17	Lower limit of AO1 output	-100.0%–P06.19	0.0%
P06.18	Corresponding AO1 output of lower limit	0.00V–10.00V	0.00V
P06.19	Upper limit of AO1 output	P06.17–100.0%	100.0%
P06.20	Corresponding AO1 output of upper limit	0.00V–10.00V	10.00V
P06.21	AO1 output filter time	0.000s–10.000s	0.000s
P06.22	Reserved		

Function code	Name	Description	Default value
P06.23	PTC constant output current setting	0.000–20.000mA	4.000mA
P06.24	PTC resistance alarm threshold	0–60000Ω	750Ω
P06.25	PTC resistance alarm recovery threshold	0–60000Ω	150Ω
P06.26	Actual PTC resistance	0–60000Ω	0Ω
P06.27	Lower limit of HDO output	-100.0%–P06.29	0.0%
P06.28	Corresponding HDO output of lower limit	0.00–50.00kHz	0.0kHz
P06.29	Upper limit of HDO output	P06.27–100.0%	100.0%
P06.30	Corresponding HDO output of upper limit	0.00–50.00kHz	50.00kHz
P06.31	HDO output filter time	0.000s–10.000s	0.000s

5.5.11 Digital input

G500 series inverter carries four programmable digital input terminals and two HDI input terminals. The function of all the digital input terminals can be programmed by function codes. HDI input terminal can be set to act as high-speed pulse input terminal or common digital input terminal; if it is set to act as high-speed pulse input terminal, users can also set HDIA or HDIB high-speed pulse input to serve as the frequency reference and encoder signal input.

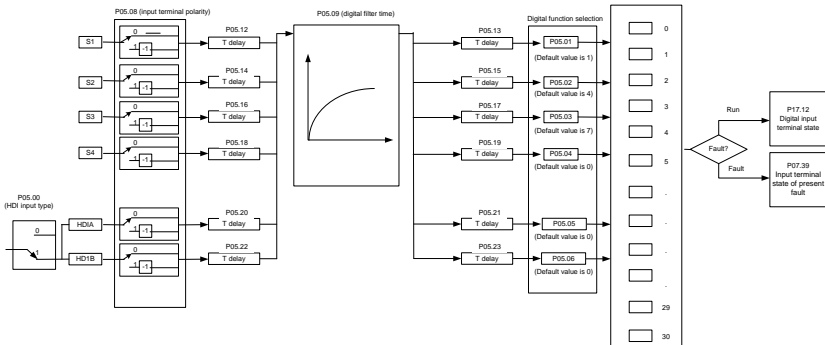

This parameter is used to set the corresponding function of digital multi-function input terminals.

Note: Two different multi-function input terminals cannot be set to the same function.

Set value	Function	Description

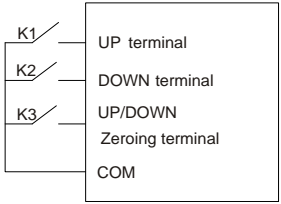
Set value	Function	Description
0	No function	The inverter does not act even if there is signal input; users can set the unused terminals to "no function" to avoid misacts.
1	Forward running (FWD)	Control the forward/reverse running of the inverter by external terminals.
2	Reverse running (REV)	
3	3-wire control/Sin	Set the inverter running mode to 3-wire control mode by this terminal. See P05.13 for details.
4	Forward jogging	Frequency when jogging, see P08.06, P08.07 and P08.08 for jogging acceleration/deceleration time.
5	Reverse jogging	
6	Coast to stop	The inverter blocks output, and the stop process of motor is uncontrolled by the inverter. This mode is applied in cases of large-inertia load and free stop time; its definition is the same with P01.08, and it is mainly used in remote control.
7	Fault reset	External fault reset function, its function is the same with the STOP/RST key on the keypad. This function can be used in remote fault reset.
8	Running pause	The inverter decelerates to stop, however, all the running parameters are in memory state, eg PLC parameter, wobbling frequency, and PID parameter. After this signal disappears, the inverter will revert to the state before stop.
9	External fault input	When external fault signal is transmitted to the inverter, the inverter releases fault alarm and stops.
10	Frequency increase (UP)	Used to change the frequency-increase/decrease command when the frequency is given by external terminals.
11	Frequency decrease (DOWN)	
12	Clear frequency increase/decrease setting	 <p>The terminal used to clear frequency-increase/decrease setting can clear the frequency value of auxiliary channel set by UP/DOWN, thus restoring the reference frequency to the frequency given by main reference frequency command channel.</p>

Set value	Function	Description				
13	Switching between A setting and B setting	This function is used to switch between the frequency setting channels.				
14	Switching between combination setting and A setting	A frequency reference channel and B frequency reference channel can be switched by no. 13 function; the combination channel set by P00.09 and the A frequency reference channel can be switched by no. 14 function; the combination channel set by P00.09 and the B frequency reference channel can be switched by no. 15 function.				
15	Switching between combination setting and B setting					
16	Multi-step speed terminal 1					
17	Multi-step speed terminal 2	16-step speeds can be set by combining digital states of these four terminals. Note: Multi-step speed 1 is low bit, multi-step speed 4 is high bit.				
18	Multi-step speed terminal 3					
19	Multi-step speed terminal 4		Multi-step speed 4	Multi-step speed 3	Multi-step speed 2	Multi-step speed 1
			BIT3	BIT2	BIT1	BIT0
20	Multi-step speed pause	Pause multi-step speed selection function to keep the set value in present state.				
21	Acceleration/deceleration time selection 1	Use these two terminals to select four groups of acceleration/decoration time.				
22	Acceleration/deceleration time selection 2		Terminal 1	Terminal 2	Acceleration or deceleration time selection	Corresponding parameter
			OFF	OFF	Acceleration/ deceleration time 1	P00.11/P00.12
			ON	OFF	Acceleration/ deceleration time 2	P08.00/P08.01
			OFF	ON	Acceleration/ deceleration time 3	P08.02/P08.03
ON	ON	Acceleration/ deceleration time 4	P08.04/P08.05			
23	Simple PLC stop reset	Restart simple PLC process and clear previous PLC state information.				
24	Simple PLC pause	The program pauses during PLC execution, and keeps running in current speed step. After this function is cancelled, simple PLC keeps running.				
25	PID control pause	PID is ineffective temporarily, and the inverter maintains current frequency output.				
26	Wobbling frequency pause (stop at current frequency)	The inverter pauses at current output. After this function is canceled, it continues wobbling-frequency operation at current frequency.				

Set value	Function	Description
27	Wobbling frequency reset (revert to center frequency)	The set frequency of inverter reverts to center frequency.
28	Counter reset	Zero out the counter state.
29	Switching between speed control and torque control	The inverter switches from torque control mode to speed control mode, or vice versa.
30	Acceleration/deceleration disabled	Ensure the inverter will not be impacted by external signals (except for stop command), and maintains current output frequency.
31	Counter trigger	Enable pulse counting of the counter.
33	Clear frequency increase/decrease setting temporarily	When the terminal is closed, the frequency value set by UP/DOWN can be cleared to restore the reference frequency to the frequency given by frequency command channel; when terminal is disconnected, it will revert to the frequency value after frequency increase/decrease setting.
34	DC brake	The inverter starts DC brake immediately after the command becomes valid.
35	Switching between motor 1 and motor 2	When this terminal is valid, users can realize switch-over control of two motors.
36	Command switches to keypad	When this terminal is valid, the running command channel will switch to keypad compulsorily. If this function becomes invalid, the running command channel will revert to the original state.
37	Command switches to terminal	When this terminal is valid, the running command channel will switch to terminal compulsorily. If this function becomes invalid, the running command channel will revert to the original state.
38	Command switches to communication	When this terminal is valid, the running command channel will switch to communication compulsorily. If this function becomes invalid, the running command channel will revert to the original state.
39	Pre-existing command	When this terminal is valid, motor pre-existing will be started until this terminal becomes invalid.
40	Zero out power consumption quantity	After this command becomes valid, the power consumption quantity of the inverter will be zeroed out.
41	Maintain power consumption quantity	When this command is valid, current operation of the inverter will not impact the power consumption quantity.
42	Source of upper torque limit switches to keypad	When this command is valid, the upper limit of the torque will be set by keypad

Set value	Function	Description
56	Emergency stop	When this command is valid, the motor decelerate to emergency stop as per the time set by P01.26.
57	Motor over-temperature fault input	Motor stops at motor over-temperature fault input.
59	FVC switches to V/F control	When this terminal is valid in stop state, switch to SVPWM control.
60	Switch to FVC control	When this terminal is valid in stop state, switch to closed-loop vector control.
61	PID polarity switch-over	Switching the output polarity of PID, this terminal should be used in conjunction with P09.03
66	Zero out the counter	Zero out the position counting value
67	Pulse increase	When the terminal function is valid, the pulse input is increased according to the P21.27 pulse speed.
68	Enable pulse superimposition	When the pulse superimposition is enabled, pulse increase and pulse decrease are effective.
69	Pulse decrease	When the terminal function is valid, the pulse input is decreased according to the P21.27 pulse speed.
70	Electronic gear selection	When the terminal is valid, the proportional numerator is switched to the P21.30 numerator of the 2 nd command ratio.
71	Switch to master	In stopped state, if the function is valid, the master is used.
72	Switch to slave	In stopped state, if the function is valid, the slave is used.
73	Reset roll diameter	Used to reset the roll diameter when the tension control function is enabled.
74	Switch winding/unwinding	Used to switch winding/unwinding modes when the tension control function is enabled.
75	Tension control pre-drive	If the terminal is valid when the tension control function is enabled, tension control pre-drive is performed.
76	Disable roll diameter calculation	If the terminal is valid when the tension control function is enabled, roll diameter calculation is disabled.
77	Clear alarm display	Used to clear the alarm display when the tension control function is enabled.
78	Manual braking of tension control	If the terminal is valid when the tension control function is enabled, manual braking is activated.
79	Trigger forced feeding interrupt	If the terminal is valid when the tension control function is enabled, a feeding interrupt signal is triggered forcibly.
80	Initial roll diameter 1	Used to select different initial roll diameters by combining

Set value	Function	Description
		with the initial roll diameter 2 when the tension control function is enabled.
81	Initial roll diameter 2	Used to select different initial roll diameters by combining with the initial roll diameter 1 when the tension control function is enabled.
82	Trigger fire mode control	In fire mode, if the terminal is valid, the fire mode control signal is triggered.
83	Switch tension PID parameters	Used to switch two PID parameter groups when the tension control function is enabled. The first group is used by default. If the terminal is valid, the second group is used.
84–95	Reserved	

Related parameter list:

Function code	Name	Description	Default value
P05.00	HDI input type	0x00–0x11 Ones: HDIA input type 0: HDIA is high-speed pulse input 1: HDIA is digital input Tens: HDIB input type 0: HDIB is high-speed pulse input 1: HDIB is digital input	0x00
P05.01	Function of S1 terminal	0: No function	1
P05.02	Function of S2 terminal	1: Forward running	4
P05.03	Function of S3 terminal	2: Reverse running	7
P05.04	Function of S4 terminal	3: 3-wire control/Sin	0
P05.05	Function of HDIA terminal	4: Forward jogging	0
P05.06	Function of HDIB terminal	5: Reverse jogging 6: Coast to stop	0
P05.07	Reserved variables	7: Fault reset 8: Running pause 9: External fault input 10: Frequency increase (UP) 11: Frequency decrease (DOWN) 12: Clear frequency increase/decrease setting 13: Switch-over between setting sources A and B 14: Switch-over between combination	0

Function code	Name	Description	Default value
		setting mode and setting source A 15: Switch-over between combination setting mode and setting source B 16: Multi-step speed terminal 1 17: Multi-step speed terminal 2 18: Multi-step speed terminal 3 19: Multi-step speed terminal 4 20: Multi-step speed pause 21: Acceleration/deceleration time selection 1 22: Acceleration/deceleration time selection 2 23: Simple PLC stop reset 24: Simple PLC pause 25: PID control pause 26: Wobbling frequency pause 27: Wobbling frequency reset 28: Counter reset 29: Switching between speed control and torque control 30: Acceleration/deceleration disabled 31: Counter trigger 32: Reserved 33: Clear frequency increase/decrease setting temporarily 34: DC brake 35: Switching between motor 1 and motor 2 36: Command switches to keypad 37: Command switches to terminal 38: Command switches to communication 39: Pre-existing command 40: Zero out power consumption quantity 41: Maintain power consumption quantity 42: Switching the upper torque limit setting mode to keypad 43: Reserved 44: Spindle orientation disabled 45: Spindle zeroing/local position	

Function code	Name	Description	Default value
		zeroing 46: Spindle zero-position setting 1 47: Spindle zero-position setting 2 48: Spindle indexing setting 1 49: Spindle indexing setting 2 50: Spindle indexing setting 3 51: Terminal for switching between position control and speed control 52: Disable pulse input 53: Eliminate position deviation 54: Switch position proportional gain 55: Enable cyclic digital positioning 56: Emergency stop 57: Motor overtemperature fault input 59: Switch to V/F control 60: Switch to FVC control 61: PID polarity switch-over 66: Zero out encoder counting 67: Pulse increase 68: Enable pulse superimposition 69: Pulse decrease 70: Electronic gear selection 71: Switch to the master 72: Switch to the slave 73: Reset the roll diameter 74: Switch winding/unwinding 75: Pre-drive 76: Disable roll diameter calculation 77: Clear alarm display 78: Manual braking 79: Trigger forced feeding interrupt 80: Initial roll diameter 1 81: Initial roll diameter 2 82: Trigger fire mode control 83: Switch tension PID parameters 84–95: Reserved	
P05.08	Polarity of input terminal	0x00–0x3F	0x00
P05.09	Digital filter time	0.000–1.000s	0.010s
P05.10	Virtual terminal setting	0x00–0x3F (0: disable, 1: enable) BIT0: S1 virtual terminal BIT1: S2 virtual terminal BIT2: S3 virtual terminal	0x00

Function code	Name	Description	Default value
		BIT3: S4 virtual terminal BIT4: HDIA virtual terminal BIT5: HDIB virtual terminal	
P05.11	2/3-wire control mode	0: 2-wire control 1 1: 2-wire control 2 2: 3-wire control 1 3: 3-wire control 2	0
P05.12	S1 terminal switch-on delay	0.000–50.000s	0.000s
P05.13	S1 terminal switch-off delay	0.000–50.000s	0.000s
P05.14	S2 terminal switch-on delay	0.000–50.000s	0.000s
P05.15	S2 terminal switch-off delay	0.000–50.000s	0.000s
P05.16	S3 terminal switch-on delay	0.000–50.000s	0.000s
P05.17	S3 terminal switch-off delay	0.000–50.000s	0.000s
P05.18	S4 terminal switch-on delay	0.000–50.000s	0.000s
P05.19	S4 terminal switch-off delay	0.000–50.000s	0.000s
P05.20	HDIA terminal switch-on delay	0.000–50.000s	0.000s
P05.21	HDIA terminal switch-off delay	0.000–50.000s	0.000s
P05.22	HDIB terminal switch-on delay	0.000–50.000s	0.000s
P05.23	HDIB terminal switch-off delay	0.000–50.000s	0.000s
P07.39	Input terminal state of present fault	/	0
P17.12	Digital input terminal state	/	0

5.5.12 Digital output

G500 series inverter carries two groups of relay output terminals, one open collector Y output terminal and one high-speed pulse output (HDO) terminal. The function of all the digital output terminals can be programmed by function codes, of which the high-speed pulse output terminal HDO can also be set to high-speed pulse output or digital output by function code.

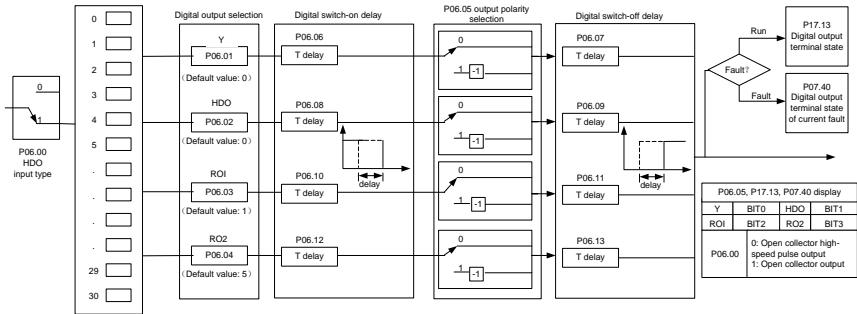

The table below lists the options for the above four function parameters, and users are allowed to select the same output terminal functions repetitively.

Set value	Function	Description
0	Invalid	Output terminal has no function
1	In running	Output ON signal when there is frequency output during running
2	In forward running	Output ON signal when there is frequency output during forward running
3	In reverse running	Output ON signal when there is frequency output during reverse running
4	In jogging	Output ON signal when there is frequency output during jogging
5	Inverter fault	Output ON signal when inverter fault occurred
6	Frequency level detection FDT1	Refer to P08.32 and P08.33
7	Frequency level detection FDT2	Refer to P08.34 and P08.35
8	Frequency reached	Refer to P08.36
9	Running in zero speed	Output ON signal when the inverter output frequency and reference frequency are both zero.
10	Reach upper limit frequency	Output ON signal when the running frequency reaches upper limit frequency
11	Reach lower limit frequency	Output ON signal when the running frequency reached lower limit frequency
12	Ready to run	Main circuit and control circuit powers are established, the protection functions do not act; when the inverter is ready to run, output ON signal.
13	In pre-existing	Output ON signal during pre-existing of the inverter

Set value	Function	Description
14	Overload pre-alarm	Output ON signal after the pre-alarm time elapsed based on the pre-alarm threshold; see P11.08–P11.10 for details.
15	Underload pre-alarm	Output ON signal after the pre-alarm time elapsed based on the pre-alarm threshold; see P11.11–P11.12 for details.
16	Simple PLC state completed	Output signal when current stage of simple PLC is completed
17	Simple PLC cycle completed	Output signal when a single cycle of simple PLC operation is completed
23	Virtual terminal output of Modbus/Modbus TCP communication	Output corresponding signal based on the set value of Modbus/Modbus TCP; output ON signal when it is set to 1, output OFF signal when it is set to 0
24	Virtual terminal output of PROFIBUS\CANopen communication	Output corresponding signal based on the set value of PROFIBUS\CANopen; output ON signal when it is set to 1, output OFF signal when it is set to 0
25	Virtual terminal output of Ethernet communication	Output corresponding signal based on the set value of Ethernet; output ON signal when it is set to 1, output OFF signal when it is set to 0.
26	DC bus voltage established	Output is valid when the bus voltage is above the undervoltage threshold of the inverter
27	Z pulse output	Output is valid when the encoder Z pulse is arrived, and is invalid after 10 ms.
28	During pulse superposition	Output is valid when the pulse superposition terminal input function is valid
29	STO action	Output when STO fault occurred
30	Positioning completed	Output is valid when position control positioning is completed
31	Spindle zeroing completed	Output is valid when spindle zeroing is completed
32	Spindle scale-division completed	Output is valid when spindle scale-division is completed
33	In speed limit	Output is valid when the frequency is limited
34	Virtual terminal output of EtherCAT/PROFINET/EtherNet IP/G500ETH communication	The corresponding signal is output according to the set value of PROFINET communication. When it is set to 1, the ON signal is output, and when it is set to 0, the OFF signal is output.

Set value	Function	Description
35	Reserved	
36	Speed/position control switch-over completed	Output is valid when the mode switch-over is completed
37-40	Reserved	
41	Y1	Y1 from the programmable card
42	Y2	Y2 from the programmable card
43	HDO	HDO from the programmable card
44	RO1	RO1 from the programmable card
45	RO2	RO2 from the programmable card
46	RO3	RO3 from the programmable card
47	RO4	RO4 from the programmable card
48	EC PT100 detected OH pre-alarm	Pre-alarm of overheating (OH) detected by the expansion card (EC) with PT100.
49	EC PT1000 detected OH pre-alarm	Pre-alarm of OH detected by the EC with PT1000.
50	AI/AO detected OH pre-alarm	Pre-alarm of OH detected by AI/AO.
51	Stopped or running at zero speed	The inverter is in stopped state or running at zero speed.
52	Disconnection detected in tension control	Disconnection is detected when the disconnection detection is enabled in tension control.
53	Roll diameter setting reached	The set roll diameter is reached during running in tension control.
54	Max. roll diameter reached	The max. roll diameter is reached during running in tension control.
55	Min. roll diameter reached	The min. roll diameter is reached during running in tension control.
56	Fire control mode enabled	The fire mode is turned on.
57-63	Reserved	/

Related parameter list:

Function code	Name	Description	Default value
P06.00	HDO output type	0: Open collector high-speed pulse output 1: Open collector output	0
P06.01	Y output selection	0: Invalid	0
P06.02	HDO output selection	1: In running 2: In forward running	0
P06.03	Relay RO1 output selection	3: In reverse running 4: In jogging	1
P06.04	Relay RO2 output	5: Inverter fault	5

Function code	Name	Description	Default value
	selection	6: Frequency level detection FDT1 7: Frequency level detection FDT2 8: Frequency reached 9: Running in zero speed 10: Reach upper limit frequency 11: Reach lower limit frequency 12: Ready to run 13: In pre-existing 14: Overload pre-alarm 15: Underload pre-alarm 16: Simple PLC stage completed 17: Simple PLC cycle completed 18: Reach set counting value 19: Reach designated counting value 20: External fault is valid 21: Reserved 22: Reach running time 23: Virtual terminal output of Modbus/Modbus TCP communication 24: Virtual terminal output of PROFIBUS/CANopen communication 25: Virtual terminal output of Ethernet communication 26: DC bus voltage established 27: Z pulse output 28: During pulse superposition 29: STO action 30: Positioning completed 31: Spindle zeroing completed 32: Spindle scale-division completed 33: Speed limit reached in torque control 34: Virtual terminal output of EtherCAT/PROFINET/EtherNet IP/ G500ETH communication 35: Reserved 36: Speed/position control switch-over completed 37-40: Reserved 41: Y1 from the programmable card 42: Y2 from the programmable card 43: HDO from the programmable card	

Function code	Name	Description	Default value
		44: RO1 from the programmable card 45: RO2 from the programmable card 46: RO3 from the programmable card 47: RO4 from the programmable card 48: EC PT100 detected OH pre-alarm 49: EC PT1000 detected OH pre-alarm 50: AI/AO detected OH pre-alarm 51: Stopped or running at zero speed 52: Disconnection detected in tension control 53: Roll diameter setting reached 54: Max. roll diameter reached 55: Min. roll diameter reached 56: Fire control mode enabled 57: S1 status 58: S2 status 59: S3 status 60: S4 status 61: HDIA status 62: HDIB status 63: Reserved	
P06.05	Output terminal polarity selection	0x00–0x0F	0x00
P06.06	Y switch-on delay	0.000–50.000s	0.000s
P06.07	Y switch-off delay	0.000–50.000s	0.000s
P06.08	HDO switch-on delay	0.000–50.000s (valid only when P06.00=1)	0.000s
P06.09	HDO switch-off delay	0.000–50.000s (valid only when P06.00=1)	0.000s
P06.10	Relay RO1 switch-on delay	0.000–50.000s	0.000s
P06.11	Relay RO1 switch-off delay	0.000–50.000s	0.000s
P06.12	Relay RO2 switch-on delay	0.000–50.000s	0.000s
P06.13	Relay RO2 switch-off delay	0.000–50.000s	0.000s
P07.40	Output terminal state of present fault	/	0
P17.13	Digital output terminal state	/	0

5.5.13 Simple PLC

Simple PLC is a multi-step speed generator, and the inverter can change the running frequency and direction automatically based on the running time to fulfill process requirements. Previously, such function was realized with external PLC, while now, the inverter itself can achieve this function.

G500 series inverter can realize 16-step speeds control, and provide four groups of acceleration/deceleration time for users to choose from.

After the set PLC completes one cycle (or one section), one ON signal can be output by the multi-function relay.

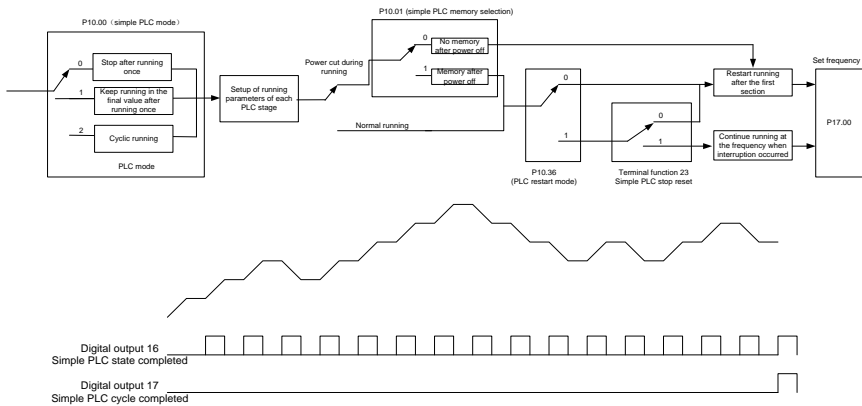

Related parameter list:

Function code	Name	Description	Default value
P05.01–P05.06	Digital input function	23: Simple PLC stop reset 24: Simple PLC pause 25: PID control pause	
P06.01–P06.04	Digital output function	16: Simple PLC stage reached 17: Simple PLC cycle reached	
P10.00	Simple PLC mode	0: Stop after running once 1: Keep running in the final value after running once 2: Cyclic running	0
P10.01	Simple PLC memory selection	0: No memory after power down 1: Memory after power down	0
P10.02	Multi-step speed 0	-100.0–100.0%	0.0%
P10.03	Running time of step 0	0.0–6553.5s (min)	0.0s
P10.04	Multi-step speed 1	-100.0–100.0%	0.0%

Function code	Name	Description	Default value
P10.05	Running time of step 1	0.0–6553.5s (min)	0.0s
P10.06	Multi-step speed 2	-100.0–100.0%	0.0%
P10.07	Running time of step 2	0.0–6553.5s (min)	0.0s
P10.08	Multi-step speed 3	-100.0–100.0%	0.0%
P10.09	Running time of step 3	0.0–6553.5s (min)	0.0s
P10.10	Multi-step speed 4	-100.0–100.0%	0.0%
P10.11	Running time of step 4	0.0–6553.5s (min)	0.0s
P10.12	Multi-step speed 5	-100.0–100.0%	0.0%
P10.13	Running time of step 5	0.0–6553.5s (min)	0.0s
P10.14	Multi-step speed 6	-100.0–100.0%	0.0%
P10.15	Running time of step 6	0.0–6553.5s (min)	0.0s
P10.16	Multi-step speed 7	-100.0–100.0%	0.0%
P10.17	Running time of step 7	0.0–6553.5s (min)	0.0s
P10.18	Multi-step speed 8	-100.0–100.0%	0.0%
P10.19	Running time of step 8	0.0–6553.5s (min)	0.0s
P10.20	Multi-step speed 9	-100.0–100.0%	0.0%
P10.21	Running time of step 9	0.0–6553.5s (min)	0.0s
P10.22	Multi-step speed 10	-100.0–100.0%	0.0%
P10.23	Running time of step 10	0.0–6553.5s (min)	0.0s
P10.24	Multi-step speed 11	-100.0–100.0%	0.0%
P10.25	Running time of step 11	0.0–6553.5s (min)	0.0s
P10.26	Multi-step speed 12	-100.0–100.0%	0.0%
P10.27	Running time of step 12	0.0–6553.5s (min)	0.0s
P10.28	Multi-step speed 13	-100.0–100.0%	0.0%
P10.29	Running time of step 13	0.0–6553.5s (min)	0.0s
P10.30	Multi-step speed 14	-100.0–100.0%	0.0%
P10.31	Running time of step 14	0.0–6553.5s (min)	0.0s
P10.32	Multi-step speed 15	-100.0–100.0%	0.0%
P10.33	Running time of step 15	0.0–6553.5s (min)	0.0s
P10.36	PLC restart mode	0: Restart from the first section 1: Continue running at the frequency when interruption occurred	0
P10.34	Acceleration/deceleration time of 0–7 stage of simple PLC	0x0000–0xFFFF	0000

Function code	Name	Description	Default value
P10.35	Acceleration/deceleration time of 8–15 stage of simple PLC	0x0000–0XFFFF	0000
P05.01–P05.09	Digital input function	23: Simple PLC stop reset 24: Simple PLC pause 25: PID control pause	
P06.01–P06.04	Digital output function	16: Simple PLC stage reached 17: Simple PLC cycle reached	
P17.00	Set frequency	0.00Hz–P00.03 (Max. output frequency)	0.00Hz
P17.27	Simple PLC and current stage number of multi-step speed	0–15	0

5.5.14 Multi-step speed running

Set the parameters used in multi-step speed running. G500 inverter can set 16-step speeds, which are selectable by multi-step speed terminals 1–4, corresponding to multi-step speed 0 to multi-step speed 15.

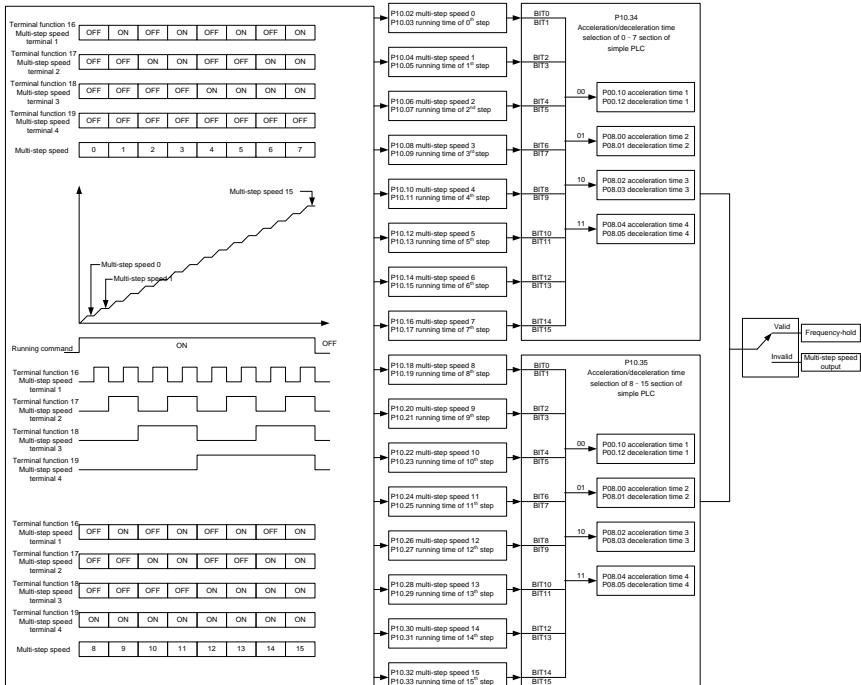

Related parameter list:

Function code	Name	Description	Default value
P05.01– P05.06	Digital input function selection	16: Multi-step speed terminal 1 17: Multi-step speed terminal 2 18: Multi-step speed terminal 3 19: Multi-step speed terminal 4 20: Multi-step speed pause	
P10.02	Multi-step speed 0	-100.0–100.0%	0.0%
P10.03	Running time of step 0	0.0–6553.5s (min)	0.0s
P10.04	Multi-step speed 1	-100.0–100.0%	0.0%
P10.05	Running time of step 1	0.0–6553.5s (min)	0.0s
P10.06	Multi-step speed 2	-100.0–100.0%	0.0%
P10.07	Running time of step 2	0.0–6553.5s (min)	0.0s
P10.08	Multi-step speed 3	-100.0–100.0%	0.0%
P10.09	Running time of step 3	0.0–6553.5s (min)	0.0s
P10.10	Multi-step speed 4	-100.0–100.0%	0.0%
P10.11	Running time of step 4	0.0–6553.5s (min)	0.0s
P10.12	Multi-step speed 5	-100.0–100.0%	0.0%
P10.13	Running time of step 5	0.0–6553.5s (min)	0.0s
P10.14	Multi-step speed 6	-100.0–100.0%	0.0%
P10.15	Running time of step 6	0.0–6553.5s (min)	0.0s
P10.16	Multi-step speed 7	-100.0–100.0%	0.0%
P10.17	Running time of step 7	0.0–6553.5s (min)	0.0s
P10.18	Multi-step speed 8	-100.0–100.0%	0.0%
P10.19	Running time of step 8	0.0–6553.5s (min)	0.0s
P10.20	Multi-step speed 9	-100.0–100.0%	0.0%
P10.21	Running time of step 9	0.0–6553.5s (min)	0.0s
P10.22	Multi-step speed 10	-100.0–100.0%	0.0%
P10.23	Running time of step 10	0.0–6553.5s (min)	0.0s
P10.24	Multi-step speed 11	-100.0–100.0%	0.0%
P10.25	Running time of step 11	0.0–6553.5s (min)	0.0s
P10.26	Multi-step speed 12	-100.0–100.0%	0.0%
P10.27	Running time of step 12	0.0–6553.5s (min)	0.0s
P10.28	Multi-step speed 13	-100.0–100.0%	0.0%
P10.29	Running time of step 13	0.0–6553.5s (min)	0.0s
P10.30	Multi-step speed 14	-100.0–100.0%	0.0%
P10.31	Running time of step 14	0.0–6553.5s (min)	0.0s
P10.32	Multi-step speed 15	-100.0–100.0%	0.0%

Function code	Name	Description	Default value
P10.33	Running time of step 15	0.0–6553.5s (min)	0.0s
P10.34	Acceleration/decoration time selection of 0–7 section of simple PLC	0x0000–0XFFFF	0000
P10.35	Acceleration/decoration time selection of 8–15 section of simple PLC	0x0000–0XFFFF	0000
P05.01–P05.09	Digital input function selection	16: Multi-step speed terminal 1 17: Multi-step speed terminal 2 18: Multi-step speed terminal 3 19: Multi-step speed terminal 4 20: Multi-step speed pause	/
P17.27	Simple PLC and current steps of multi-step speed	0–15	0

5.5.15 PID control

PID control, a common mode for process control, is mainly used to adjust the inverter output frequency or output voltage through performing scale-division, integral and differential operations on the difference between feedback signal of controlled variables and signal of the target, thus forming a negative feedback system to keep the controlled variables above the target. It is suitable for flow control, pressure control, temperature control, etc. Diagram of basic principles for output frequency regulation is shown in the figure below.

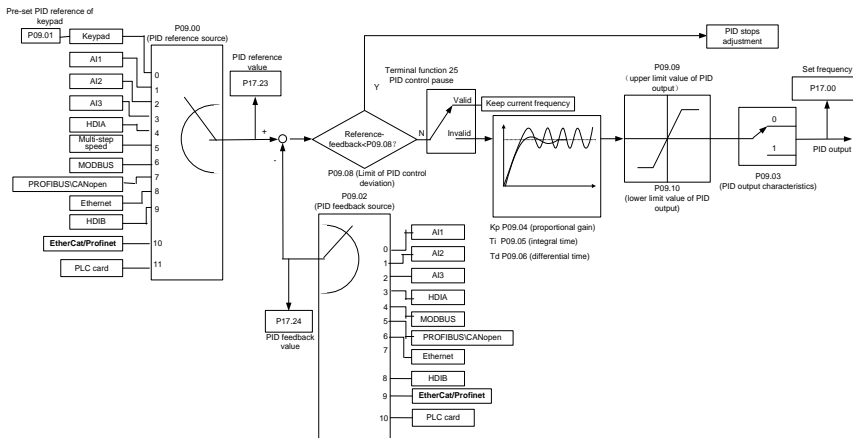

Introduction to the working principles and control methods for PID control

Proportional control (Kp): When the feedback deviates from the reference, the output will be

proportional to the deviation, if such deviation is constant, the regulating variable will also be constant. Proportional control can respond to feedback changes rapidly, however, it cannot eliminate the error by itself. The larger the proportional gain, the faster the regulating speed, but too large gain will result in oscillation. To solve this problem, first, set the integral time to a large value and the derivative time to 0, and run the system by proportional control, and then change the reference to observe the deviation between feedback signal and the reference (static difference), if the static difference is (eg, increase the reference, and the feedback variable is always less than the reference after system stabilizes), continue increasing the proportional gain, otherwise, decrease the proportional gain; repeat such process until the static error becomes small.

Integral time (Ti): When feedback deviates from reference, the output regulating variable accumulates continuously, if the deviation persists, the regulating variable will increase continuously until deviation disappears. Integral regulator can be used to eliminate static difference; however, too large regulation may lead to repetitive overshoot, which will cause system instability and oscillation. The feature of oscillation caused by strong integral effect is that the feedback signal fluctuates up and down based on the reference variable, and fluctuation range increases gradually until oscillation occurred. Integral time parameter is generally regulated gradually from large to small until the stabilized system speed fulfills the requirement.

Derivative time (Td): When the deviation between feedback and reference changes, output the regulating variable which is proportional to the deviation variation rate, and this regulating variable is only related to the direction and magnitude of the deviation variation rather than the direction and magnitude of the deviation itself. Differential control is used to control the feedback signal variation based on the variation trend. Differential regulator should be used with caution as it may easily enlarge the system interferences, especially those with high variation frequency.

When frequency command selection (P00.06, P00.07) is 7, or channel of voltage setting (P04.27) is 6, the running mode of inverter is process PID control.

5.5.15.1 General procedures for PID parameter setting

a. Determining proportional gain P

When determining proportional gain P, first, remove the integral term and derivative term of PID by making $T_i=0$ and $T_d=0$ (see PID parameter setting for details), thus turning PID into pure proportional control. Set the input to 60%–70% of the max. allowable value, and increase proportional gain P gradually from 0 until system oscillation occurred, and then in turn, decrease proportional gain P gradually from current value until system oscillation disappears, record the proportional gain P at this point and set the proportional gain P of PID to 60%–70% of current value. This is whole commissioning process of proportional gain P.

b. Determine integral time Ti

After proportional gain P is determined, set the initial value of a larger integral time T_i , and decrease T_i gradually until system oscillation occurred, and then in turn, increase T_i until system oscillation disappears, record the T_i at this point, and set the integral time constant T_i of PID to 150%–180% of current value. This is the commissioning process of integral time constant T_i .

c. Determining derivative time T_d

The derivative time T_d is generally set to 0.

If users need to set T_d to another value, set in the same way with P and T_i , namely set T_d to 30% of the value when there is no oscillation.

d. Empty system load, perform load-carrying joint debugging, and then fine-tune PID parameter until fulfilling the requirement.

5.5.15.2 How to fine-tune PID

After setting the parameters controlled by PID, users can fine-tune these parameters by the following means.

Control overmodulation: When overmodulation occurred, shorten the derivative time (T_d) and prolong integral time (T_i).

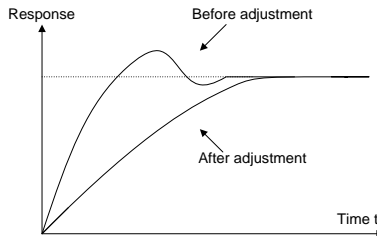

Stabilize the feedback value as fast as possible: when overmodulation occurred, shorten integral time (T_i) and prolong derivative time (T_d) to stabilize control as fast as possible.

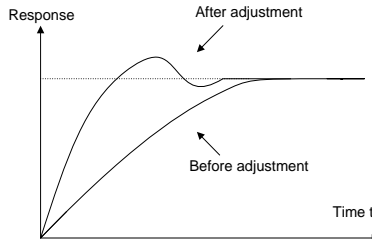

Control long-term vibration: If the cycle of periodic vibration is longer than the set value of integral time (T_i), it indicates the integral action is too strong, prolong the integral time (T_i) to control vibration.

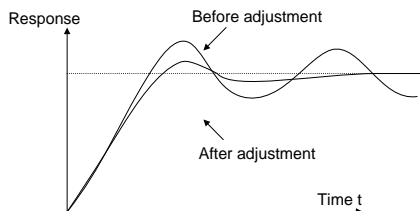

Control short-term vibration: If the vibration cycle is short is almost the same with the set value of derivative time (Td), it indicates derivative action is too strong, shorten the derivative time (Td) to control vibration. When derivative time (Td) is set to 0.00 (namely no derivative control), and there is no way to control vibration, decrease the proportional gain.

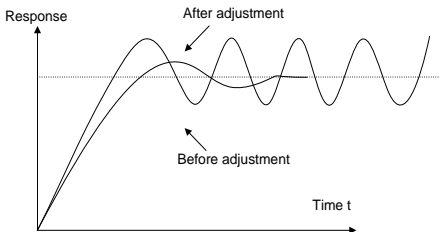

Related parameter list:

Function code	Name	Description	Default value
P09.00	PID reference source	0: Keypad (P09.01) 1: AI1 2: AI2 3: AI3 4: High-speed pulse HDIA 5: Multi-step 6: Modbus/Modbus TCP communication 7: PROFIBUS/CANopen/DeviceNet/ G500XLT communication 8: Ethernet communication 9: High-speed pulse HDIB 10: EtherCAT/PROFINET/EtherNet IP/ G500ETH communication 11: Programmable expansion card 12: Reserved	0
P09.01	Pre-set PID reference of keypad	-100.0%–100.0%	0.0%
P09.02	PID feedback source	0: AI1 1: AI2 2: AI3 3: High-speed pulse HDIA 4: Modbus/Modbus TCP communication 5: PROFIBUS/CANopen/DeviceNet/ G500XLT communication 6: Ethernet communication 7: High-speed pulse HDIB	0

Function code	Name	Description	Default value
		8: EtherCAT/PROFINET/EtherNet IP/ G500ETH communication 9: Programmable expansion card 10: Reserved	
P09.03	PID output characteristics	0: PID output is positive characteristic 1: PID output is negative characteristic	0
P09.04	Proportional gain (Kp)	0.00–100.00	1.80
P09.05	Integral time (Ti)	0.01–10.00s	0.90s
P09.06	Derivative time (Td)	0.00–10.00s	0.00s
P09.07	Sampling cycle (T)	0.000–10.000s	0.100s
P09.08	Limit of PID control deviation	0.0–100.0%	0.0%
P09.09	Upper limit value of PID output	P09.10–100.0% (max. frequency or voltage)	100.0%
P09.10	Lower limit value of PID output	-100.0%–P09.09 (max. frequency or voltage)	0.0%
P09.11	Feedback offline detection value	0.0–100.0%	0.0%
P09.12	Feedback offline detection time	0.0–3600.0s	1.0s
P09.13	PID control selection	0x0000–0x1111 Ones: 0: Continue integral control after the frequency reaches upper/lower limit 1: Stop integral control after the frequency reaches upper/lower limit Tens: 0: The same with the main reference direction 1: Contrary to the main reference direction Hundreds: 0: Limit as per the max. frequency 1: Limit as per A frequency Thousands: 0: A+B frequency, acceleration /deceleration of main reference A frequency source buffering is invalid 1: A+B frequency, acceleration/	0x0001

Function code	Name	Description	Default value
		deceleration of main reference A frequency source buffering is valid, acceleration/deceleration is determined by P08.04 (acceleration time 4).	
P17.00	Set frequency	0.00Hz–P00.03 (Max. output frequency)	0.00Hz
P17.23	PID reference value	-100.0–100.0%	0.0%
P17.24	PID feedback value	-100.0–100.0%	0.0%

5.5.16 Run at wobbling frequency

Wobbling frequency is mainly applied in cases where transverse movement and winding functions are needed like textile and chemical fiber industries. The typical working process is shown as below.

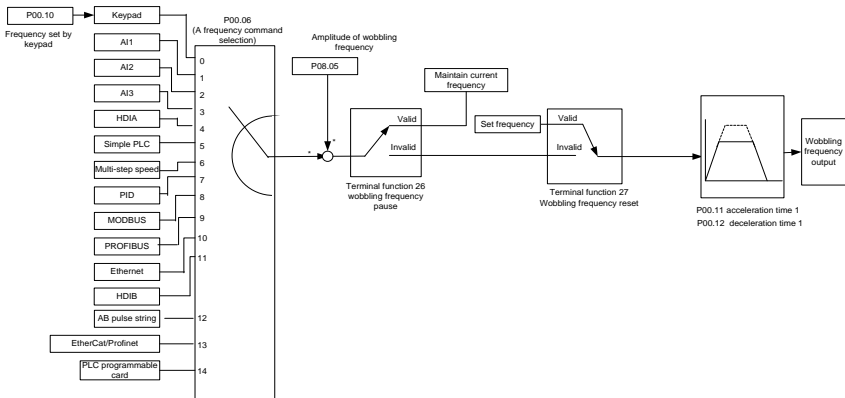

Function code	Name	Description	Default value
P00.03	Max. output frequency	P00.03–400.00Hz	60.00Hz
P00.06	A frequency command selection	0: Set via keypad 1: Set via AI1 2: Set via AI2 3: Set via AI3 4: Set via high speed pulse HDIA 5: Set via simple PLC program 6: Set via multi-step speed running 7: Set via PID control 8: Set via Modbus/Modbus TCP communication 9: Set via PROFIBUS / CANopen /	0

Function code	Name	Description	Default value
		DeviceNet/ G500XLT communication 10: Set via Ethernet communication 11: Set via high speed pulse HDIB 12: Set via pulse string AB 13: Set via EtherCAT/PROFINET/ EthernetIP/ G500ETH communication 14: Set via PLC card	
P00.11	Acceleration time 1	0.0–3600.0s	Depend on model
P00.12	Deceleration time 1	0.0–3600.0s	Depend on model
P05.01– P05.06	Digital input function selection	26: Wobbling frequency pause (stop at current frequency) 27: Wobbling frequency reset (revert to center frequency)	/
P08.15	Amplitude of wobbling frequency	0.0–100.0% (relative to set frequency)	0.0%
P08.16	Amplitude of jump frequency	0.0–50.0% (relative to amplitude of wobbling frequency)	0.0%
P08.17	Wobbling frequency rise time	0.1–3600.0s	5.0s
P08.18	Wobbling frequency fall time	0.1–3600.0s	5.0s

5.5.17 Local encoder input

G500 series inverter supports pulse count function by inputting the count pulse from HDI high-speed pulse port. When the actual count value is no less than the set value, digital output terminal will output count-value-reached pulse signal, and the corresponding count value will be zeroed out.

Function code	Name	Description	Default value
P05.00	HDI input type	0x00–0x11 Ones: HDIA input type 0: HDIA is high-speed pulse input 1: HDIA is digital input Tens: HDIB input type 0: HDIB is high-speed pulse input 1: HDIB is digital input	0x00
P05.38	HDIA high-speed pulse input function	0: Set input via frequency 1: Reserved	0

Function code	Name	Description	Default value
		2: Input via encoder, used in combination with HDIB	
P05.44	HDIB high-speed pulse input function selection	0: Set input via frequency 1: Reserved 2: Input via encoder, used in combination with HDIA	0
P20.15	Speed measurement mode	0: PG card 1: local; realized by HDIA and HDIB; supports incremental 24V encoder only	0
P18.00	Actual frequency of encoder	-999.9–3276.7Hz	0.0Hz

5.5.18 Commissioning procedures for position control and spindle positioning function

1. Commissioning procedures for closed-loop vector control of asynchronous motor

Step 1: Restore to default value via keypad

Step 2: Set P00.03, P00.04 and P02 group motor nameplate parameters

Step 3: Motor parameter autotuning

Carry out rotary parameter autotuning or static parameter autotuning via keypad, if the motor can be disconnected from load, then it is users can carry out rotary parameter autotuning; otherwise, carry out static parameter autotuning, the parameter obtained from autotuning will be saved in P02 motor parameter group automatically.

Step 4: Verify whether the encoder is installed and set properly

a) Confirm the encoder direction and parameter setting

Set P20.01 (encoder pulse-per-revolution), set P00.00=2 and P00.10=20Hz, and run the inverter, at this point, the motor rotates at 20Hz, observe whether the speed measurement value of P18.00 is correct, if the value is negative, it indicates the encoder direction is reversed, under such situation, set P20.02 to 1; if the speed measurement value deviates greatly, it indicates P20.01 is set improperly. Observe whether P18.02 (encoder Z pulse count value) fluctuates, if yes, it indicates the encoder suffers interference or P20.01 is set improperly, requiring users to check the wiring and the shielding layer.

b) Determine Z pulse direction

Set P00.10=20Hz, and set P00.13 (running direction) to forward and reverse direction respectively to observe whether the difference value of P18.02 is less than 5, if the difference value remains to be larger than 5 after setting Z pulse reversal function of P20.02, power off and exchange phase A and phase B of the encoder, and then observe the difference between the value of P18.02 during forward and reverse rotation. Z pulse direction only affects the forward/reverse positioning precision of the spindle positioning carried out with Z pulse.

Step 5: Closed-loop vector pilot-run

Set P00.00=3, and carry out closed-loop vector control, adjust P00.10 and speed loop and current loop PI parameter in P03 group to make it run stably in the whole range.

Step 6: Flux-weakening control

Set flux-weakening regulator gain P03.26=0–8000, and observe the flux-weakening control effect. P03.22–P03.24 can be adjusted as needed.

2. Commissioning procedures for closed-loop vector control of synchronous motor

Step 1: Set P00.18=1, restore to default value

Step 2: Set P00.00=3 (FVC), set P00.03, P00.04, and motor nameplate parameters in P02 group.

Step 3: Set P20.00 and P20.01 encoder parameters

When the encoder is resolver-type encoder, set the encoder pulse count value to (resolver pole pair number × 1024), eg, if pole pair number is 4, set P20.01 to 4096.

Step 4: Ensure the encoder is installed and set correctly

When motor stops, observe whether P18.21 (resolver angle) fluctuates, if it fluctuates sharply, check the wiring and grounding. Rotates the motor slowly, observe whether P18.21 changes accordingly. If yes, it indicates motor is connected correctly; if the value of P18.02 keeps constant at a non-zero value after rotating for multiple circles, it indicates encoder Z signal is correct.

Step 5: Autotuning of initial position of magnetic pole

Set P20.11=2 or 3 (3: rotary autotuning; 2: static autotuning), press RUN key to run the inverter.

a) Rotary autotuning (P20.11 = 3)

Detect the position of current magnetic pole when autotuning starts, and then accelerates to 10Hz, autotuning corresponding magnetic pole position of encoder Z pulse, and decelerate to stop.

During running, if ENC1O or ENC1D fault occurred, set P20.02=1 and carry out autotuning again.

After autotuning is done, the angle obtained from autotuning will be saved in P20.09 and P20.10 automatically.

b) Static autotuning

In cases where the load can be disconnected, it is recommended to adopt rotary autotuning (P20.11=3) as it has high angle precision. If the load cannot be disconnected, users can adopt static autotuning (P20.11=2). The magnetic pole position obtained from autotuning will be saved in P20.09 and P20.10.

Step 6: Closed-loop vector pilot-run

Adjust P00.10 and speed loop and current loop PI parameter in P03 group to make it run stably in the whole range. If oscillation occurred, reduce the value of P03.00, P03.03, P03.09 and P03.10. If current oscillation noise occurred during low speed, adjust P20.05.

Note: It is necessary to re-determine P20.02 (encoder direction) and carry out magnetic pole position autotuning again if the wiring of motor or encoder is changed.

3. Commissioning procedures for pulse string control

Pulse input is operated based on closed-loop vector control; speed detection is needed in the subsequent spindle positioning, zeroing operation and division operation.

Step 1: Restore to default value by keypad

Step 2: Set P00.03, P00.04 and motor nameplate parameters in P02 group

Step 3: Motor parameter autotuning: rotary parameter autotuning or static parameter autotuning

Step 4: Verify the installation and settings of encoder. Set P00.00=3 and P00.10=20Hz to run the system, and check the control effect and performance of the system.

Step 5: Set P21.00=0001 to set positioning mode to position control, namely pulse-string control. There are four kinds of pulse command modes, which can be set by P21.01 (pulse command mode).

Under position control mode, users can check high bit and low bit of position reference and feedback, P18.02 (count value of Z pulse), P18.00 (actual frequency of encoder), P18.17 (pulse command frequency) and P18.19 (position regulator output) via P18, through which users can figure out the relation between P18.8 (position of position reference point) and P18.02, pulse command frequency P18.17, feedforward P18.18 and position regulator output P18.19.

Step 6: The position regulator has two gains, namely P21.02 and P21.03, and they can be switched by speed command, torque command and terminals.

Step 7: When P21.08 (output limit of position controller) is set to 0, the position control will be invalid, and at this point, the pulse string acts as frequency source, P21.13 (position feedforward gain) should be set to 100%, and the speed acceleration/deceleration time is determined by the acceleration /deceleration time of pulse string, the pulse string acceleration/deceleration time of the system can be adjusted. If the pulse string acts as the frequency source in speed control, users can also set P21.00 to 0000, and set the frequency source reference P00.06 or P00.07 to 12 (set by pulse string AB), at this point, the acceleration/deceleration time is determined by the acceleration/deceleration time of the inverter, meanwhile, the parameters of pulse string AB is still set by P21 group. In speed mode, the filter time of pulse string AB is determined by P21.29.

Step 8: The input frequency of pulse string is the same with the feedback frequency of encoder pulse, the relation between them can be changed by altering P21.11 (numerator of position command ratio) and P21.12 (denominator of position command ratio)

Step 9: When running command or servo enabling is valid (by setting P21.00 or terminal function 63), it will enter pulse string servo running mode.

4. Commissioning procedures for spindle positioning

Spindle orientation is to realize orientation functions like zeroing and division based on closed-loop vector control

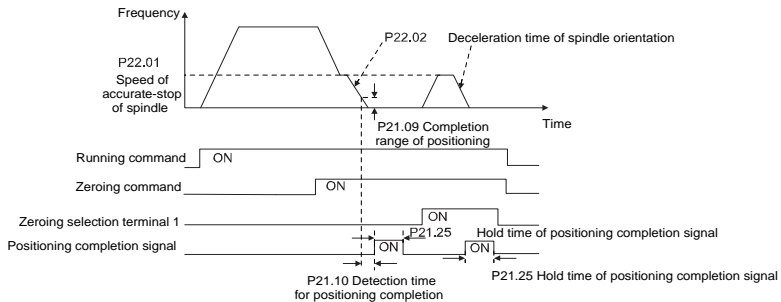

Step 1–4: These four steps are the same with the first four steps of the commissioning procedures for closed-loop vector control, which aim to fulfill the control requirements of closed-loop vector control, thus realizing spindle positioning function in either position control or speed control mode.

Step 5: Set P22.00.bit0=1 to enable spindle positioning, set P22.00.bit1 to select spindle zero input. If the system adopts encoder for speed measurement, set P22.00.bit1 to 0 to select Z pulse input; if the system adopts photoelectric switch for speed measurement, set P22.00.bit1 to 1 to select photoelectric switch as zero input; set P22.00.bit2 to select zero search mode, set P22.00.bit3 to enable or disable zero calibration, and select zero calibration mode by setting P22.00.bit7.

Step 6: Spindle zeroing operation

a) Select the positioning direction by setting P22.00.bit4;

b) There are four zero positions in P22 group, users can choose one out of four zeroing positions by setting zeroing input terminal selection (46, 47) in P05 group. When executing zeroing function, the motor will stop accurately at corresponding zeroing position according to the set positioning direction, which can be viewed via P18.10;

c) The positioning length of spindle zeroing is determined by the deceleration time of accurate-stop and the speed of accurate-stop;

Step 7: Spindle division operation

There are seven scale-division positions in P22 group, users can choose one out of seven scale-division positions by setting scale-division input terminal selection (48, 49, 50) in P05 group. Enable corresponding scale-division terminal after the motor stops accurately, and the motor will check the scale-division position state and switch to corresponding position incrementally, at this point, users can check P18.09.

Step 8: Priority level of speed control, position control and zeroing

The priority level of speed running is higher than that of the scale division, when the system runs in scale-division mode, if spindle orientation is prohibited, the motor will turn to speed mode or position mode.

The priority level of zeroing is higher than that of the scale division.

Scale-division command is valid when the scale-division terminal is from 000 state to non-000 state, eg, in 000–011, the spindle executes scale division 3. The transition time during terminal switch-over

needs to be less than 10ms; otherwise, wrong scale division command may be executed.

Step 9: Hold positioning

The position loop gain during positioning is P21.03; while the position loop gain in positioning-completion-hold state is P21.02. In order to keep sufficient position-hold force and ensure no system oscillation occurred, adjust P03.00, P03.01, P20.05 and P21.02.

Step 10: Positioning command selection (bit6 of P22.00)

Electric level signal: Positioning command (zeroing and scale division) can be executed only when there is running command or the servo is enabled.

Step 11: Spindle reference point selection (bit0 of P22.00)

Encoder Z pulse positioning supports the following spindle positioning modes:

- a) the encoder is installed on the motor shaft, the motor shaft and spindle is 1:1 rigid connection;
- b) the encoder is installed on the motor shaft, the motor shaft and spindle is 1:1 belt connection;

At this point, the belt may slip during high-speed running and cause inaccurate positioning, it is recommended to install proximity switch on the spindle.

- c) The encoder is installed on the spindle, and the motor shaft is connected to the spindle with belt, the drive ratio is not necessarily 1:1;

At this point, set P20.06 (speed ratio of the mounting shaft between motor and encoder), and set P22.14 (spindle drive ratio) to 1. As the encoder is not installed on the motor, the control performance of closed-loop vector will be affected.

Proximity switch positioning supports the following spindle positioning modes:

- a) The encoder is installed on the motor shaft, the drive ratio between motor shaft and spindle is not necessarily 1:1;

At this point, it is required to set P22.14 (spindle drive ratio).

5. Commissioning procedures for digital positioning

The diagram for digital positioning is shown below.

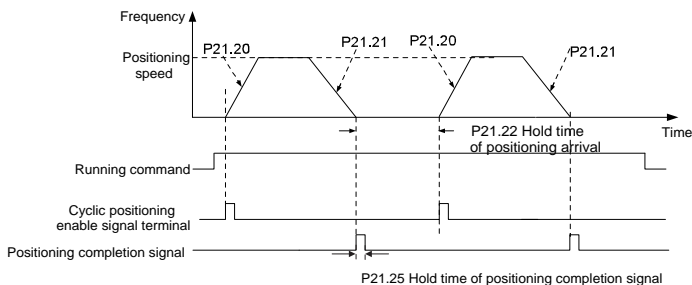

Step 1–4: These four steps are the same with the first four steps of the commissioning procedures for

closed-loop vector control, which aim to fulfill the control requirements of closed-loop vector control.

Step 5: Set P21.00=0011 to enable digital positioning. Set P21.17, P21.11 and P21.12 (set positioning displacement) according to actual needs; set P21.18 and P21.19 (set positioning speed); set P21.20 and P21.21 (set acceleration/deceleration time of positioning).

Step 6: Single positioning operation

Set P21.16.bit1=0, and the motor will carry out single positioning action and stay in the positioning position according to the setting in step 5.

Step 7: Cyclic positioning operation

Set P21.16.bit1=1 to enable cyclic positioning. The cyclic positioning is divided into continuous mode and repetitive mode; users can also carry out cyclic positioning through terminal function (no. 55, enable digital positioning cycle)

6. Commissioning procedures for positioning of photoelectric switch

Photoelectric switch positioning is to realize positioning function based on closed-loop vector control.

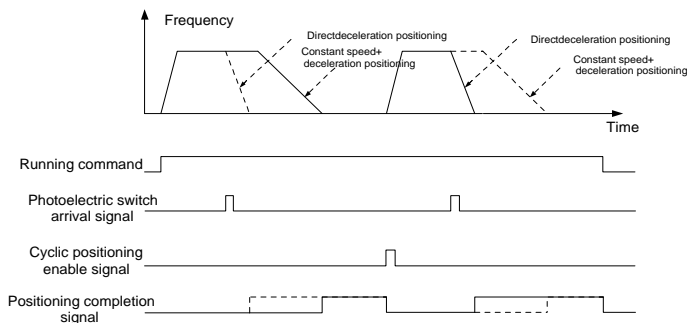

Step 1–4: These four steps are the same with the first four steps of the commissioning procedures for closed-loop vector control, which aim to fulfill the control requirements of closed-loop vector control.

Step 5: Set P21.00=0021 to enable photoelectric switch positioning, the photoelectric switch signal can be connected to S8 terminal only, and set P05.08=43, meanwhile, set P21.17, P21.11 and P21.12 (set positioning displacement) based on actual needs; set P21.21 (deceleration time of positioning), however, when present running speed is too fast or the set positioning displacement is too small, the deceleration time of positioning will be invalid, and it will enter direct deceleration positioning mode.

Step 6: Cyclic positioning

After positioning is done, the motor will stay in current position. Users can set cyclic positioning through input terminal function selection (55: enable cyclic digital positioning) in P05 group; when the terminal receives cyclic positioning enable signal (pulse signal), the motor will continue running in the set speed as per the speed mode and re-enter positioning state after encountering photoelectric switch.

(7) Hold positioning

The position loop gain during positioning is P21.03; while the position loop gain in positioning-completion-hold state is P21.02. In order to keep sufficient position-hold force and ensure no system oscillation occurred, adjust P03.00, P03.01, P20.05 and P21.02.

5.5.19 Fault handling

G500 series inverter provides abundant information concerning fault handling for the convenience of the users.

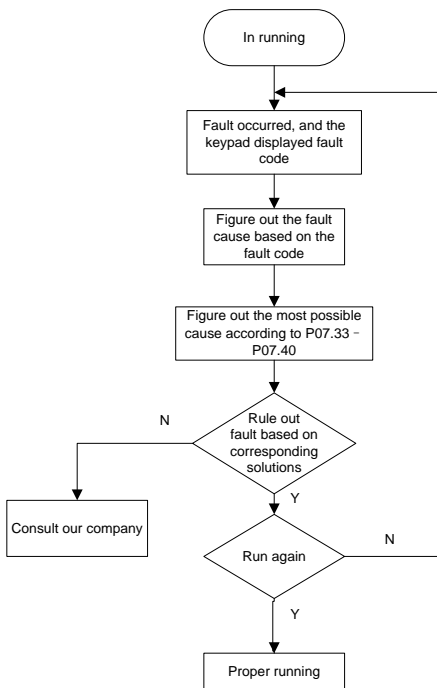

Related parameter list:

Function code	Name	Description	Default value
P07.27	Current fault	0: No fault	0
P07.28	Second to last fault	1: Inverter unit U phase protection (OUt1)	/
P07.29	Third to last fault	2: Inverter unit V phase protection (OUt2)	/
P07.30	Fourth to last fault	3: Inverter unit W phase protection (OUt3)	/
P07.31	Fifth to last fault	4: Overcurrent during acceleration (OC1)	/
P07.32	Sixth to last fault	5: Overcurrent during deceleration (OC2)	/
		6: Overcurrent during constant speed	

Function code	Name	Description	Default value
		(OC3) 7: Overvoltage during acceleration (OV1) 8: Overvoltage during deceleration (OV2) 9: Overvoltage during constant speed (OV3) 10: Bus undervoltage fault (UV) 11: Motor overload (OL1) 12: Inverter overload (OL2) 13: Phase loss on input side (SPI) 14: Phase loss on output side (SPO) 15: Rectifier module overheat (OH1) 16: Inverter module overheat (OH2) 17: External fault (EF) 18: 485 communication fault (CE) 19: Current detection fault (ItE) 20: Motor autotuning fault (tE) 21: EEPROM operation fault (EEP) 22: PID feedback offline fault (PIDE) 23: Brake unit fault (bCE) 24: Running time reached (END) 25: Electronic overload (OL3) 26: Keypad communication error (PCE) 27: Parameter upload error (UPE) 28: Parameter download error (DNE) 29: Profibus DP communication fault (E-DP) 30: Ethernet communication fault (E-NET) 31: CANopen communication fault (E-CAN) 32: To-ground short-circuit fault 1 (ETH1) 33: To-ground short-circuit fault 2 (ETH2) 34: Speed deviation fault (dEu) 35: Mal-adjustment fault (STo) 36: Underload fault (LL) 37: Encoder offline fault (ENC1O) 38: Encoder reversal fault (ENC1D) 39: Encoder Z pulse offline fault (ENC1Z) 40: Safe torque off (STO) 41: Channel H1 safety circuit exception (STL1) 42: Channel H2 safety circuit exception (STL2)	

Function code	Name	Description	Default value
		43: Channel H1 and H2 exception (STL3) 44: Safety code FLASH CRC check fault (CrCE) 55: Repetitive expansion card type fault (E-Err) 56: Encoder UVW loss fault (ENCUV) 57: PROFINET communication timeout fault (E-PN) 58: CAN communication fault (SECAN) 59: Motor over-temperature fault (OT) 60: Card slot 1 card identification failure (F1-Er) 61: Card slot 2 card identification failure (F2-Er) 62: Card slot 3 card identification failure (F3-Er) 63: Card slot 1 card communication timeout fault (C1-Er) 64: Card slot 2 card communication timeout fault (C2-Er) 65: Card slot 3 card communication timeout fault (C3-Er) 66: EtherCAT communication fault (E-CAT) 67: Bacnet communication fault (E-BAC) 68: DeviceNet communication fault (E-DEV) 69: Master-slave synchronous CAN slave fault (S-Err) 70: EC PT100 detected overheating (OtE1) 71: EC PT1000 detected overheating (OtE2) 72: EtherNet/IP communication timeout (E-EIP) 73: No upgrade bootloader (E-PAO) 74: AI1 disconnected (E-AI1) 75: AI2 disconnected (E-AI2) 76: AI3 disconnected (E-AI3) 77: G500ETH fault (E-E71) 78: G500XLT fault (E-E72) 79: Reserved	

Function code	Name	Description	Default value
P07.33	Running frequency of present fault		0.00Hz
P07.34	Ramps reference frequency of present fault		0.00Hz
P07.35	Output voltage of present fault		0V
P07.36	Output current of present fault		0.0A
P07.37	Bus voltage of present fault		0.0V
P07.38	Max. temperature of present fault		0.0°C
P07.39	Input terminal state of present fault		0
P07.40	Output terminal state of present fault		0
P07.41	Running frequency of the last fault		0.00Hz
P07.42	Ramps reference frequency of the last fault		0.00Hz
P07.43	Output voltage of the last fault		0V
P07.44	Output current of the last fault		0.0A
P07.45	Bus voltage of the last fault		0.0V
P07.46	Max. temperature of the last fault		0.0°C
P07.47	Input terminal state of the last fault		0
P07.48	Output terminal state of the last fault		0
P07.49	Running frequency of the second to last fault		0.00Hz
P07.50	Ramps reference frequency of the second to last fault		0.00Hz
P07.51	Output voltage of the second to last fault		0V
P07.52	Output current of the second to last fault		0.0A
P07.53	Bus voltage of the second to last fault		0.0V
P07.54	Max. temperature of the second to last fault		0.0°C
P07.55	Input terminal state of the second to last fault		0
P07.56	Output terminal state of the second to last fault		0

5.5.20 Tension control solutions

In many fields of industrial production, precise tension control is needed to maintain a constant output tension of the drive equipment, in order to improve the quality of the products. In the winding and unwinding of some industries such as paper processing, printing and dyeing, packing, wire and cable manufacturing, textile, fiber, optic cable, leather, metal foil material processing and so on, tension needs to keep constant.

The inverter controls the tension by regulating the motor output torque or speed. There are three modes to control the tension: speed mode, open-loop torque mode and closed-loop torque mode.

5.5.20.1 Typical tension control applications for winding/unwinding

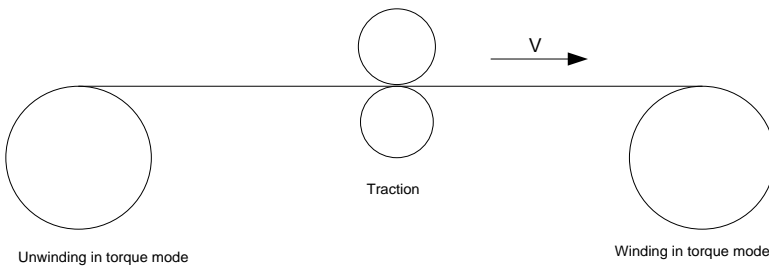
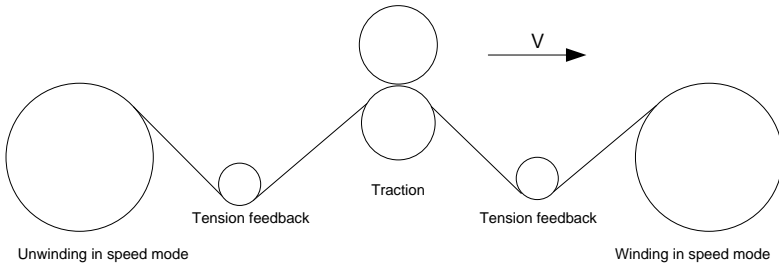
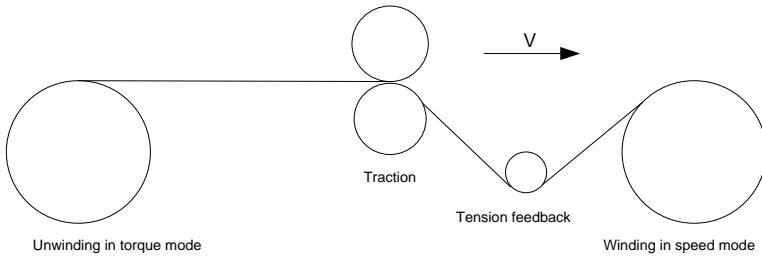
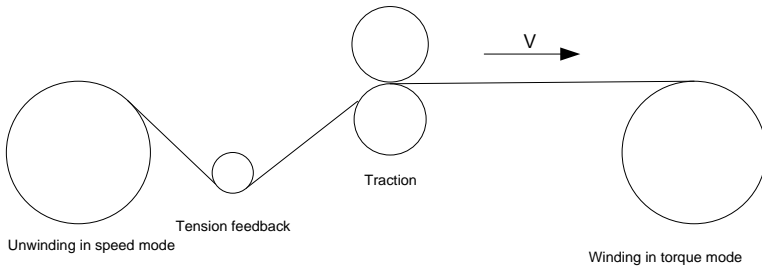

In some special situations, if the roll diameter can be counted through thickness, the following applications can be implemented:

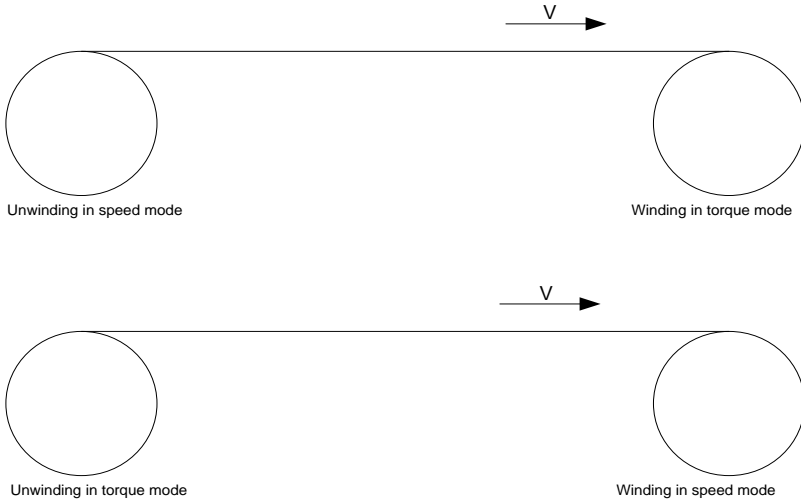

5.5.20.2 Speed control

The detection feedback signal is needed in the closed-loop adjustment. PID calculation is carried out according to the feedback signal for the motor speed regulation, linear speed and stable tension control. If the tension rocker or floating roller is used for feedback, changing the set value (PID reference) may change the actual tension, and at the same time, changing the mechanical configuration such as the tension rocker or floating roller weight can also change the tension.

The control principle is as follows.

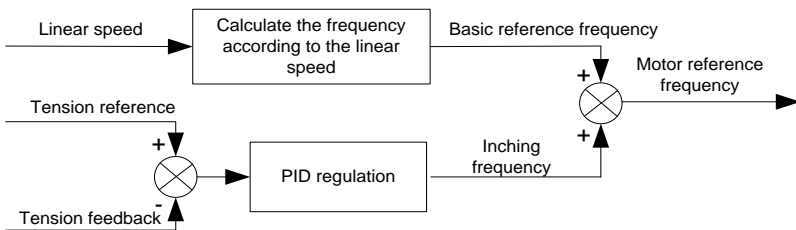

Related modules:

- (1) Linear speed input module: It is important for the calculation of the basic setting frequency according to the linear speed and the calculation of roll diameter according to the linear speed.
- (2) Real-time roll diameter calculation module: The calculation accuracy of roll diameter determines the control performance. The roll diameter can be calculated according to the inverter output frequency and the linear speed. In addition, it can also be calculated through the thickness or sensor.

The linear speed is widely used for the calculation. If the set linear speed is used for the calculation, you can choose whether to enable the function of roll diameter change limiting.

(3) PID regulation module: There are two groups of PID parameters in P09. The linear speed synchronization and stable tension can be kept through PID regulation. PID parameters can be modified based on site commissioning. The two groups of PID parameters can be switched for PID regulation improvement.

(4) Material feeding interrupt detection and processing module: The function is valid when material feeding interrupt detection has been enabled.

(5) Pre-drive: This function is applied to automatic reel change. After the inverter is started if the pre-drive function terminal is valid, the roller runs at the set linear speed. If the terminal is invalid, the inverter will automatically switch to the corresponding control mode after a period of time.

5.5.20.3 Open-loop torque mode

Open loop means there is no tension feedback signal. In this mode, stable tension can be achieved by means of motor torque control. The rotation speed automatically changes with the linear speed of material. The control basis is as follows: For a reel control system, the relationship between the tension F of the roller with materials, present roll diameter D and output torque of the shaft is: $T = F \times D / 2$. If the output torque can be adjusted according to the variation of roll diameter, the tension can be controlled. In order to ensure the constant tension in the process of acceleration and deceleration, the internal friction compensation module and inertia compensation module have been built in the inverter to calculate the real time rotation inertia, and compensate the torque according to the actual speed change rate. The control principle is shown in the following figure.

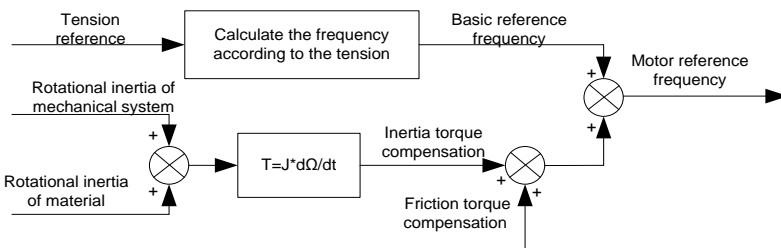

Relevant modes:

(1) Linear speed input module: It has two functions: calculating the synchronous frequency in torque control according to the linear speed, and calculating the roll diameter according to the linear speed.

(2) Tension setting module: Used to set the tension adapting to the control system. It needs to be adjusted according to the actual situation. After confirmation, the value remains the same. In some scenarios where the forming effect after winding needs to be improved, the tension taper function can be used so that the tension decreases as the roll diameter increases.

(3) Real-time roll diameter calculation module: The calculation accuracy of roll diameter determines the control performance. The roll diameter can be calculated according to the inverter output

frequency and the linear speed. In addition, it can also be calculated through the thickness or sensor. The linear speed is widely used for the calculation. If the set linear speed is used for the calculation, you can choose whether to enable the function of roll diameter change limiting.

(4) Torque compensation module: Torque compensation includes friction torque compensation and inertia torque compensation. Friction torque compensation is used to eliminate the impact of friction on tension, and it needs to be adjusted according to actual requirements. Rotation inertia includes inertial of mechanical systems and that of materials. In order to keep the tension stable in ACC/DEC, compensation torque is required. In some cases without strict tension control requirements, disabling rotation inertia torque compensation can also achieve the control.

(5) Material feeding interrupt detection and processing module: The function is valid when material feeding interrupt detection has been enabled.

(6) This function is applied to automatic reel change. After the inverter is started if the pre-drive function terminal is valid, the roller runs at the set linear speed. If the terminal is invalid, the inverter will automatically switch to the corresponding control mode after a period of time.

5.5.20.4 Closed-loop torque mode

Similar to the open-loop torque mode, the closed-loop torque mode has only the difference that tension detection sensors are installed on the winding/unwinding side. In addition to all the function modules supported in open-loop torque mode, this mode supports an additional tension feedback PID closed-loop regulation module. The control principle is shown in the following figure.

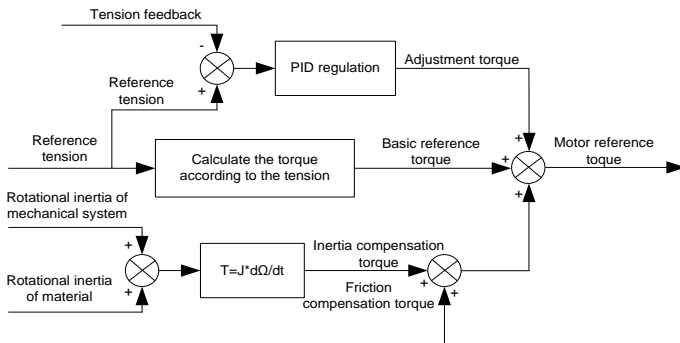

6 Parameters



Scan this QR code or go to www.galtelectric.com/support/g500/how-to-program to see video instructions of the programming guide.

6.1 What this chapter contains

This chapter lists all the function codes and corresponding description of each function code.

Note: Unless otherwise specified, the power described in this chapter refers to the ND power. For example, 0.75–55kW (1–75HP) described in this chapter refers to the ND power.

6.2 Parameter list

Function parameters of G500 series inverter are categorized according to functions. Among the function groups, P98 is analog input/output calibration group, and P99 is factory function group which cannot be accessed by users. The function code adopts three-level menu, eg, "P08.08" indicates it is the no. 8 function code in P08 group.

The function group no. corresponds to the first-level menu; function code no. corresponds to the second-level menu; function code parameter corresponds to the third-level menu.

1. The function list is divided into the following columns.

Column 1 "Function code": number of the function parameter group and the parameter;

Column 2 "Name": complete name of the function parameter;

Column 3 "Description": detailed description of this function parameter;

Column 4 "Default value": The original set value of the function parameter by default;

Column 5: "Modify": The modification attribute of the function parameter, namely whether the function parameter can be modified and the condition for modification, as shown below.

"○": the set value of this parameter can be modified when the inverter is in stop or running state;

"◎": the set value of this parameter cannot be modified when the inverter is in running state;

"●": the parameter value is the measured value which cannot be modified.

(The inverter has assigned the modification attribute of each parameter automatically to avoid inadvertent modification by users.)

2. "System of numeration for parameters" is decimal; if the parameter is presented in

hexadecimal numbers, the data of each bit will be independent of each other during parameter edit, and the value range of partial bits can be 0–F in hexadecimal system.

3. "Default value" is value restored after parameter refresh during restoring to default value; however, the measured value or recorded value will not be refreshed.
4. In order to enhance parameter protection, the inverter provides password protection for the function codes. After setting user password (namely user password P07.00 is not zero), when users press **PRG/ESC** key to enter function code edit state, the system will first enter user password verification state which displays "0.0.0.0.0.", requiring operators to input the correct user password. For factory parameters, besides user password, it is also required to input the correct factory password (users should not attempt to modify factory parameters as improper setting may easily lead to mal-operation or damage the inverter). When password protection is unlocked, the user password can be modified at any time; user password is subject to the last input. User password can be cancelled by setting P07.00 to 0; if P01.00 is set to a non-zero value, the parameter will be protected by password. When modifying function parameters through serial communication, the function of user password also follows above rules.

P00 group Basic functions

Function code	Name	Description	Default value	Modify
P00.00	Speed control mode	0:SVC 0 1:SVC 1 2:SVPWM 3:FVC Note: If 0, 1 or 3 is selected, it is required to carry out motor parameter autotuning first.	2	☉
P00.01	Running command channel	0: Keypad 1: Terminal 2: Communication	0	○
P00.02	Communication running command channel	0: Modbus/Modbus TCP 1: PROFIBUS/CANopen/DeviceNet/ G500XLT 2: Ethernet 3: EtherCAT/PROFINET/EtherNet IP/ G500ETH 4: PLC programmable card 5: Wireless communication card Note: 1, 2, 3, 4 and 5 are extended functions which are applicable with corresponding cards.	0	○
P00.03	Max. output frequency	Used to set the maximum output frequency of the inverter. It is the basis of frequency setting and the acceleration/deceleration. Setting range: Max. (P00.04, 10.00) –630.00Hz	60.00Hz	☉

Function code	Name	Description	Default value	Modify
P00.04	Upper limit of running frequency	<p>The upper limit of running frequency is upper limit value of inverter output frequency. This value cannot be more than the maximum output frequency.</p> <p>When the set frequency is higher than the upper limit frequency, the inverter runs at the upper limit frequency.</p> <p>Setting range: P00.05–P00.03 (Max. output frequency)</p>	60.00Hz	☉
P00.05	Lower limit of running frequency	<p>The lower limit of running frequency is the lower limit value of inverter output frequency.</p> <p>When the set frequency is lower than the lower limit frequency, the inverter runs at the lower limit frequency.</p> <p>Note: Max. output frequency \geq upper limit frequency \geq lower limit frequency.</p> <p>Setting range: 0.00Hz–P00.04 (upper limit of running frequency)</p>	0.00Hz	☉
P00.06	A frequency command selection	<p>0: Set via keypad</p> <p>1: Set via AI1</p> <p>2: Set via AI2</p>	0	○
P00.07	B frequency command selection	<p>3: Set via AI3</p> <p>4: Set via high speed pulse HDIA</p> <p>5: Set via simple PLC program</p> <p>6: Set via multi-step speed running</p> <p>7: Set via PID control</p> <p>8: Set via Modbus/Modbus TCP communication</p> <p>9: Set via PROFIBUS / CANopen / DeviceNet/ G500XLT communication</p> <p>10: Set via Ethernet communication</p> <p>11: Set via high speed pulse HDIB</p> <p>12: Set via pulse string AB</p> <p>13: Set via EtherCAT/PROFINET/EthernetIP/ G500ETH communication</p> <p>14: Set via PLC card</p> <p>15: Reserved</p>	15	○
P00.08	Reference object of B frequency command	<p>0: Max. output frequency</p> <p>1: A frequency command</p>	0	○

Function code	Name	Description	Default value	Modify																
P00.09	Combination mode of setting source	0: A 1: B 2: (A+B) 3: (A-B) 4: Max. (A, B) 5: Min. (A, B)	0	<input type="radio"/>																
P00.10	Set frequency via keypad	When A and B frequency commands are set by keypad, the value is the initial digital set value of the inverter frequency. Setting range: 0.00 Hz–P00.03 (Max. output frequency)	60.00Hz	<input type="radio"/>																
P00.11	Acceleration time 1	Acceleration time is the time needed for accelerating from 0Hz to Max. output frequency (P00.03).	Depend on model	<input type="radio"/>																
P00.12	Deceleration time 1	Deceleration time is the time needed from decelerating from Max. output frequency (P00.03) to 0Hz. G500 series inverter defines four groups of acceleration and deceleration time, which can be selected via multi-function digital input terminals (P05 group). The acceleration/deceleration time of the inverter is the first group by default. Setting range of P00.11 and P00.12: 0.0–3600.0s	Depend on model	<input type="radio"/>																
P00.13	Running direction	0: Run in default direction 1: Run in reverse direction 2: Reverse running is prohibited	0	<input type="radio"/>																
P00.14	Carrier frequency setting	<table border="1" style="width: 100%; border-collapse: collapse;"> <thead> <tr> <th style="width: 20%;">Carrier frequency</th> <th style="width: 20%;">Electro magnetic noise</th> <th style="width: 20%;">Noise and leakage current</th> <th style="width: 20%;">Cooling level</th> </tr> </thead> <tbody> <tr> <td>1kHz</td> <td style="text-align: center;">↑ High</td> <td style="text-align: center;">↑ Low</td> <td style="text-align: center;">↑ Low</td> </tr> <tr> <td>10kHz</td> <td style="text-align: center;">↕</td> <td style="text-align: center;">↕</td> <td style="text-align: center;">↕</td> </tr> <tr> <td>15kHz</td> <td style="text-align: center;">↓ Low</td> <td style="text-align: center;">↓ High</td> <td style="text-align: center;">↓ High</td> </tr> </tbody> </table> <p>The relation between the model and carrier frequency is shown below.</p>	Carrier frequency	Electro magnetic noise	Noise and leakage current	Cooling level	1kHz	↑ High	↑ Low	↑ Low	10kHz	↕	↕	↕	15kHz	↓ Low	↓ High	↓ High	Depend on model	<input type="radio"/>
Carrier frequency	Electro magnetic noise	Noise and leakage current	Cooling level																	
1kHz	↑ High	↑ Low	↑ Low																	
10kHz	↕	↕	↕																	
15kHz	↓ Low	↓ High	↓ High																	

Function code	Name	Description		Default value	Modify													
		<table border="1"> <thead> <tr> <th data-bbox="398 217 452 300">Model</th> <th data-bbox="455 217 816 300">Factory value of carrier frequency</th> </tr> </thead> <tbody> <tr> <td data-bbox="398 304 452 331">220V</td> <td data-bbox="455 304 816 331">0.75–55kW(1–75HP)</td> </tr> <tr> <td data-bbox="398 336 452 363" rowspan="2">460V</td> <td data-bbox="455 336 816 363">1.5–11kW(2–15HP)</td> </tr> <tr> <td data-bbox="455 368 816 395">15–55kW(20–75HP)</td> </tr> <tr> <td data-bbox="398 400 452 427"></td> <td data-bbox="455 400 816 427">75–500kW(100–675HP)</td> </tr> <tr> <td data-bbox="398 432 452 459" rowspan="3">575V</td> <td data-bbox="455 432 816 459">0.75–18.5kW (1–25HP)</td> </tr> <tr> <td data-bbox="455 464 816 491">22–55kW(30–75HP)</td> </tr> <tr> <td data-bbox="455 496 816 523">75–110kW(100–150HP)</td> </tr> </tbody> </table>		Model	Factory value of carrier frequency	220V	0.75–55kW(1–75HP)	460V	1.5–11kW(2–15HP)	15–55kW(20–75HP)		75–500kW(100–675HP)	575V	0.75–18.5kW (1–25HP)	22–55kW(30–75HP)	75–110kW(100–150HP)		
Model	Factory value of carrier frequency																	
220V	0.75–55kW(1–75HP)																	
460V	1.5–11kW(2–15HP)																	
	15–55kW(20–75HP)																	
	75–500kW(100–675HP)																	
575V	0.75–18.5kW (1–25HP)																	
	22–55kW(30–75HP)																	
	75–110kW(100–150HP)																	
		<p>Advantages of high carrier frequency are as follows: ideal current waveform, few current harmonics and small motor noise.</p> <p>Disadvantages of high carrier frequency are as follows: growing switch consumption, enlarged temperature raise, impacted output capacity; under high carrier frequency, the inverter needs to be derated for use, meanwhile, the leakage current will increase, which increases electromagnetic interference to the surroundings.</p> <p>While low carrier frequency is the contrary. Low carrier frequency will cause unstable operation at low frequency, decrease the torque, or even lead to oscillation.</p> <p>The carrier frequency of inverter is set properly by default, and it should not be changed by users at will.</p> <p>If the default carrier frequency is exceeded during use, derating is required, derate by 10% for every additional 1k carrier frequency.</p> <p>Setting range: 1.2–15.0kHz</p>																
P00.15	Motor parameter autotuning	<p>0: No operation</p> <p>1: Rotary autotuning; carry out comprehensive motor parameter autotuning; rotary autotuning is used in cases where high control precision is required;</p> <p>2: Static autotuning 1 (comprehensive autotuning); static autotuning 1 is used in cases where the motor cannot be disconnected from load;</p> <p>3: Static autotuning 2 (partial autotuning) ; when</p>		0	©													

Function code	Name	Description	Default value	Modify
		current motor is motor 1, only P02.06, P02.07 and P02.08 will be autotuned; when current motor is motor 2, only P12.06, P12.07 and P12.08 will be autotuned.		
P00.16	AVR function	0: Invalid 1: Valid during the whole process Automatic voltage regulation function is used to eliminate the impact on the output voltage of inverter when bus voltage fluctuates.	1	○
P00.17	Inverter type	0: G type, for the constant torque load of rated parameters 1: P type, for the variable torque load of rated parameters (fans and waters pumps) G500 series inverters can use G/P type, the available motor power of G type is small one power file than that of P type.	0	◎
P00.18	Function parameter restoration	0: No operation 1: Restore to default value 2: Clear fault history Note: After the selected function operations are done, this function code will be restored to 0 automatically. Restoration to default value will clear the user password, this function should be used with caution.	0	◎

P01 group Start/stop control

Function code	Name	Description	Default value	Modify
P01.00	Running mode of start	0: Direct start 1: Start after DC brake 2: Start after speed-tracking	0	◎
P01.01	Starting frequency of direct start	Starting frequency of direct startup is the initial frequency when the inverter starts. See P01.02 (hold time of starting frequency) for details. Setting range: 0.00–50.00Hz	0.50Hz	◎

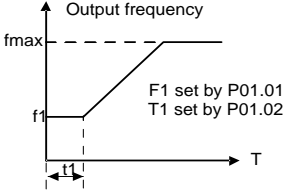
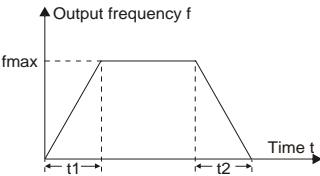
Function code	Name	Description	Default value	Modify
P01.02	Hold time of starting frequency	 <p>A proper starting frequency can increase the torque during startup. Within the hold time of starting frequency, the output frequency of inverter is the starting frequency, and then it runs from the starting frequency to the target frequency, if the target frequency (frequency command) is below the starting frequency, the inverter will be standby rather than running. The starting frequency value is unlimited by the lower limit frequency. Setting range: 0.0–50.0s</p>	0.0s	☉
P01.03	DC brake current before start	During starting, the inverter will first perform DC brake based on the set DC brake current before startup, and then it will accelerate after the set DC brake time before startup elapses. If the set DC brake time is 0, DC brake will be invalid.	0.0%	☉
P01.04	DC brake time before start	The larger the DC brake current, the stronger the brake force. The DC brake current before startup refers to the percentage relative to rated inverter current. Setting range of P01.03: 0.0–100.0% Setting range of P01.04: 0.00–50.00s	0.00s	☉
P01.05	Acceleration/deceleration mode	<p>This function code is used to select the frequency variation mode during starting and running.</p> <p>0: Straight line; the output frequency increases or decreases in straight line;</p> 	0	☉

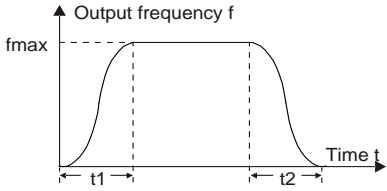
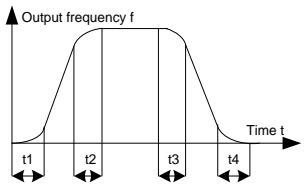
Function code	Name	Description	Default value	Modify
		<p>1: S curve; the output frequency increases or decreases in S curve; S curve is generally used in cases where smooth start/stop is required, eg, elevator, conveyer belt, etc.</p>  <p>Note: When set to 1, it is required to set P01.06, P01.07, P01.27 and P01.28 accordingly.</p>		
P01.06	Time of starting section of acceleration S curve	The curvature of S curve is determined by acceleration range and acceleration and deceleration time.	0.1s	☉
P01.07	Time of ending section of acceleration S curve	 <p>Setting range: 0.0–50.0s</p>	0.1s	☉
P01.08	Stop mode	<p>0: Decelerate to stop; after stop command is valid, the inverter lowers output frequency based on the deceleration mode and the defined deceleration time, after the frequency drops to the stop speed (P01.15), the inverter stops.</p> <p>1: Coast to stop; after stop command is valid, the inverter stops output immediately, and the load coasts to stop as per mechanical inertia.</p>	0	○
P01.09	Starting frequency of DC brake after stop	Starting frequency of DC brake after stop; during decelerating to stop, when this frequency is reached, DC brake will be performed after stop.	0.00Hz	○
P01.10	Waiting time of DC brake after stop	Demagnetization time (waiting time of DC brake after stop): Before the DC brake, the inverter will block output, and after the demagnetization time elapses, DC brake will start. This function is	0.00s	○
P01.11	DC brake current of stop		0.0%	○

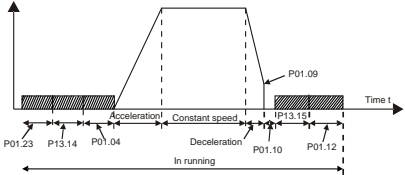
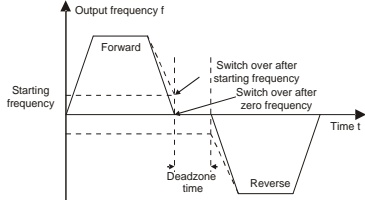
Function code	Name	Description	Default value	Modify
P01.12	DC brake time of stop	<p>used to prevent overcurrent fault caused by DC brake during high speed. DC brake current after stop: it means the DC brake force applied, the larger the current, the stronger the DC brake effect.</p>  <p>Setting range of P01.09: 0.00Hz–P00.03 (Max. output frequency) Setting range of P01.10: 0.00–30.00s Setting range of P01.11: 0.0–100.0% Setting range of P01.12: 0.0–50.0s</p>	0.00s	<input type="radio"/>
P01.13	Deadzone time of forward/reverse rotation	<p>This function code refers to the transition time of the threshold set by P01.14 during setting forward/reverse rotation of the inverter, as shown below.</p>  <p>Setting range: 0.0–3600.0s</p>	0.0s	<input type="radio"/>
P01.14	Forward/reverse rotation switch-over mode	<p>0: Switch over after zero frequency 1: Switch over after starting frequency 2: Switch over after passing stop speed and delay</p>	1	<input checked="" type="radio"/>
P01.15	Stop speed	0.00–100.00Hz	0.50Hz	<input checked="" type="radio"/>
P01.16	Stop speed detection mode	<p>0: Set value of speed (the only detection mode valid in SVPWM mode) 1: Detection value of speed</p>	0	<input checked="" type="radio"/>
P01.17	Stop speed detection time	0.00–100.00s	0.50s	<input checked="" type="radio"/>
P01.18	Running protection of power-on	When the running command channel is controlled by terminals, the system will detect	0	<input type="radio"/>

Function code	Name	Description	Default value	Modify
	terminal	running terminal state automatically during power up. 0: Terminal running command is invalid during power up. The inverter will not run during power up even if the running command terminal is detected to be valid, and the system is in running protection state. The inverter will run only after this terminal is cancelled and enabled again. 1: Terminal running command is valid during power up. The system will start the inverter automatically after initialization is done if the running command terminal is detected to be valid during power up. Note: This function must be set with caution, otherwise, serious consequences may occur.		
P01.19	Action selection when the running frequency is below lower limit (lower limit should be larger than 0)	This function code is used to set the running state of inverter when the set frequency is below lower limit frequency. Ones place: Action selection 0: Run in lower limit of the frequency 1: Stop 2: Sleep Tens place: Stop mode 0: Coast to stop 1: Decelerate to stop When the set frequency is below lower limit frequency, the inverter coasts to stop; when the set frequency is above lower limit again and continues to be so after the time set by P01.20 elapses, the inverter will be restored to running state automatically.	0x00	⊙
P01.20	Wake up from sleep delay	This function code is used to set the sleep delay. When the running frequency of inverter is below the lower limit frequency, the inverter enters sleep state; when the set frequency is above the lower limit again and continues to be so after the time set by P01.20 elapses, the inverter will run automatically.	0.0s	○

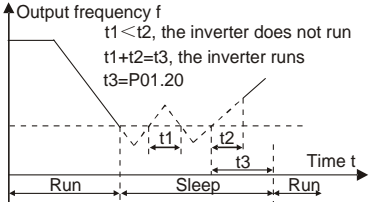
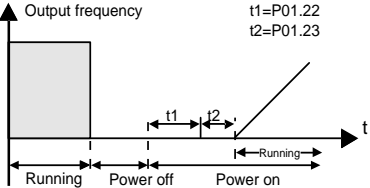
Function code	Name	Description	Default value	Modify
		 <p>Setting range: 0.0–3600.0s (valid when P.01.19 is 2)</p>		
P01.21	Restart after power cut	<p>This function code sets the automatic running of the inverter at next power-on after power down.</p> <p>0: Disabled restart 1: Enable restart, namely the inverter will run automatically after the time set by P01.22 elapses if the starting conditions are met.</p>	0	<input type="radio"/>
P01.22	Waiting time of restart after power cut	<p>This function code sets the waiting time before automatically running at next power-on after power down.</p>  <p>Setting range: 0.0–3600.0s (valid when P01.21 is 1)</p>	1.0s	<input type="radio"/>
P01.23	Start delay	<p>This function code sets the delay of the inverter's wake-up-from-sleep after running command is given, the inverter will start to run and output after the time set by P01.23 elapses to realize brake release.</p> <p>Setting range: 0.0–600.0s</p>	0.0s	<input type="radio"/>
P01.24	Stop speed delay	0.0–600.0s	0.0s	<input type="radio"/>
P01.25	Open-loop 0Hz output selection	<p>0: No voltage output 1: With voltage output 2: Output as per DC brake current of stop</p>	0	<input type="radio"/>
P01.26	Deceleration time of emergency-stop	0.0–60.0s	2.0s	<input type="radio"/>

Function code	Name	Description	Default value	Modify
P01.27	Time of starting section of deceleration S curve	0.0–50.0s	0.1s	☉
P01.28	Time of ending section of deceleration S curve	0.0–50.0s	0.1s	☉
P01.29	Short-circuit brake current	When the inverter starts in direct start mode (P01.00=0), set P01.30 to a non-zero value to enter short-circuit brake. During stop, if the running frequency of inverter is below the starting frequency of brake after stop, set P01.31 to a non-zero value to enter short-circuit brake after stop, and then carry out DC brake in the time set by P01.12 (refer to P01.09–P01.12). Setting range of P01.29: 0.0–150.0% (inverter) Setting range of P01.30: 0.0–50.0s Setting range of P01.31: 0.0–50.0s	0.0%	○
P01.30	Hold time of short-circuit brake at startup		0.00s	○
P01.31	Hold time of short-circuit brake at stop		0.00s	○
P01.32	Pre-exciting time of jogging	0–10.000s	0.300s	○
P01.33	Starting frequency of braking for jogging to stop	0–P00.03	0.00Hz	○
P01.34	Delay to enter sleep	0–3600.0s	0.0s	○

P02 group Parameters of motor 1

Function code	Name	Description	Default value	Modify
P02.00	Type of motor 1	0: Asynchronous motor 1: Synchronous motor	0	☉
P02.01	Rated power of asynchronous motor 1	0.1–3000.0kW (4023HP)	Depend on model	☉
P02.02	Rated frequency of asynchronous motor 1	0.01Hz–P00.03 (Max. output frequency)	60.00Hz	☉
P02.03	Rated speed of	1–36000rpm	Depend	☉

Function code	Name	Description	Default value	Modify
	asynchronous motor 1		on model	
P02.04	Rated voltage of asynchronous motor 1	0–1200V	Depend on model	☉
P02.05	Rated current of asynchronous motor 1	0.8–6000.0A	Depend on model	☉
P02.06	Stator resistance of asynchronous motor 1	0.001–65.535Ω	Depend on model	○
P02.07	Rotor resistance of asynchronous motor 1	0.001–65.535Ω	Depend on model	○
P02.08	Leakage inductance of asynchronous motor 1	0.1–6553.5mH	Depend on model	○
P02.09	Mutual inductance of asynchronous motor 1	0.1–6553.5mH	Depend on model	○
P02.10	No-load current of asynchronous motor 1	0.1–6553.5A	Depend on model	○
P02.11	Magnetic saturation coefficient 1 of iron core of asynchronous motor 1	0.0–100.0%	80.0%	○
P02.12	Magnetic saturation coefficient 2 of iron core of asynchronous motor 1	0.0–100.0%	68.0%	○
P02.13	Magnetic saturation coefficient 3 of iron core of asynchronous motor 1	0.0–100.0%	57.0%	○

Function code	Name	Description	Default value	Modify
P02.14	Magnetic saturation coefficient 4 of iron core of asynchronous motor 1	0.0–100.0%	40.0%	<input type="radio"/>
P02.15	Rated power of synchronous motor 1	0.1–3000.0kW (4023HP)	Depend on model	<input checked="" type="radio"/>
P02.16	Rated frequency of synchronous motor 1	0.01Hz–P00.03 (Max. output frequency)	60.00Hz	<input checked="" type="radio"/>
P02.17	Number of pole pairs of synchronous motor 1	1–128	2	<input checked="" type="radio"/>
P02.18	Rated voltage of synchronous motor 1	0–1200V	Depend on model	<input checked="" type="radio"/>
P02.19	Rated current of synchronous motor 1	0.8–6000.0A	Depend on model	<input checked="" type="radio"/>
P02.20	Stator resistance of synchronous motor 1	0.001–65.535Ω	Depend on model	<input type="radio"/>
P02.21	Direct-axis inductance of synchronous motor 1	0.01–655.35mH	Depend on model	<input type="radio"/>
P02.22	Quadrature-axis inductance of synchronous motor 1	0.01–655.35mH	Depend on model	<input type="radio"/>
P02.23	Counter-emf constant of synchronous motor 1	0–10000	300	<input type="radio"/>
P02.24	Initial pole position of SM1	0x0000–0xFFFF	0x0000	<input checked="" type="radio"/>

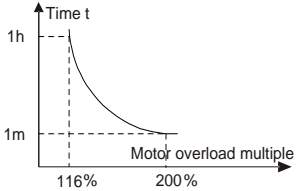
Function code	Name	Description	Default value	Modify
P02.25	Identification current of SM1	0–50%	10	●
P02.26	Overload protection of motor 1	<p>0: No protection</p> <p>1: Common motor (with low-speed compensation). As the cooling effect of common motor will be degraded in low speed, the corresponding electronic thermal protection value should also be adjusted properly, the low compensation here means to lower the overload protection threshold of the motor whose running frequency is below 30Hz.</p> <p>2: Frequency-variable motor (without low speed compensation). As the cooling effect of frequency-variable motor is not affected by the rotating speed, there is no need to adjust the protection value during low speed running.</p>	2	◎
P02.27	Overload protection coefficient of motor 1	<p>Motor overload multiples $M = I_{out} / (I_n \times K)$</p> <p>$I_n$ is rated motor current, I_{out} is inverter output current, K is motor overload protection coefficient.</p> <p>The smaller the K, the larger the value of M, and the easier the protection.</p> <p>$M = 116\%$: protection will be applied when motor overloads for 1h; $M = 200\%$: protection will be applied when motor overloads for 60s; $M \geq 400\%$: protection will be applied immediately.</p>  <p>Setting range: 20.0%–120.0%</p>	100.0%	○
P02.28	Power display calibration coefficient of motor 1	<p>This function adjusts the power display value of motor 1 only, and it does not affect the control performance of the inverter.</p> <p>Setting range: 0.00–3.00</p>	1.00	○

Function code	Name	Description	Default value	Modify
P02.29	Parameter display of motor 1	0: Display as per motor type; under this mode, only parameters related to current motor type will be displayed. 1: Display all; under this mode, all the motor parameters will be displayed.	0	<input type="radio"/>
P02.30	System inertia of motor 1	0.000–30.000kgm ²	0.000	<input type="radio"/>
P02.31–P02.32	Reserved variables	0–65535	0	<input type="radio"/>

P03 group Vector control of motor 1

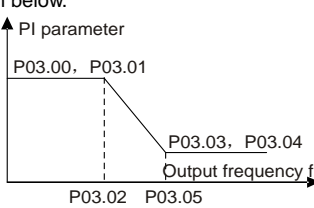
Function code	Name	Description	Default value	Modify
P03.00	Speed loop proportional gain 1	Parameters of P03.00–P03.05 fit for vector control mode only. Below P03.02, speed loop PI parameter is P03.00 and P03.01; above P03.06, speed loop PI parameter is P03.03 and P03.04; in between, PI parameter is obtained by linear variation between two groups of parameters, as shown below. 	20.0	<input type="radio"/>
P03.01	Speed loop integral time 1		0.200s	<input type="radio"/>
P03.02	Switch low point frequency		5.00Hz	<input type="radio"/>
P03.03	Speed loop proportional gain 2		20.0	<input type="radio"/>
P03.04	Speed loop integral time 2		0.200s	<input type="radio"/>
P03.05	Switch over high point frequency	The speed loop dynamic response characteristics of vector control can be adjusted by setting the proportional coefficient and integral time of speed regulator. Increase proportional gain or decrease integral time can accelerate dynamic response of speed loop, however, if the proportional gain is too large or integral time is too small, system oscillation and overshoot may occur; if proportional gain is too small, stable oscillation or speed offset may occur. Speed loop PI parameter is closely related to the	10.00Hz	<input type="radio"/>

Function code	Name	Description	Default value	Modify
		<p>system inertial, users should make adjustment based on default PI parameter according to different load characteristics to fulfill different needs.</p> <p>Setting range of P03.00:0.0–200.0; Setting range of P03.01: 0.000–10.000s Setting range of P03.02: 0.00Hz–P03.05 Setting range of P03.03: 0.0–200.0 Setting range of P03.04: 0.000–10.000s Setting range of P03.05: P03.02–P00.03 (Max. output frequency)</p>		
P03.06	Speed loop output filter	0–8 (corresponds to 0–2 ⁸ /10ms)	0	<input type="radio"/>
P03.07	Vector control slip compensation coefficient (motoring)	Slip compensation coefficient is used to adjust the slip frequency of vector control to improve speed control precision. This parameter can be used to control speed offset. Setting range: 50–200%	100%	<input type="radio"/>
P03.08	Vector control slip compensation coefficient (generating)		100%	<input type="radio"/>
P03.09	Current loop proportional coefficient P	<p>Note:</p> <p>1. These two parameters are used to adjust PI parameters of current loop; it affects dynamic response speed and control precision of the system directly. The default value needs no adjustment under common conditions; 2. Fit for SVC mode 0 (P00.00=0) and FVC mode (P00.00=3); 3. The value of this function code will be updated automatically after parameter autotuning of synchronous motor is done. Setting range: 0–65535</p>	1000	<input type="radio"/>
P03.10	Current loop integral coefficient I		1000	<input type="radio"/>
P03.11	Torque setting mode selection	0–1: Keypad (P03.12) 2: AI1 3: AI2 4: AI3 5: Pulse frequency HDIA 6: Multi-step torque 7: Modbus/Modbus TCP communication	0	<input type="radio"/>

Function code	Name	Description	Default value	Modify
		8: PROFIBUS/CANopen/DeviceNet/G500XLT communication 9: Ethernet communication 10: Pulse frequency HDIB 11: EtherCAT/PROFINET/EtherNet IP/G500EHT communication 12: Programmable card Note: For these settings, 100% corresponds to the motor rated current.		
P03.12	Torque set by keypad	-300.0%–300.0% (rated motor current)	20.0%	<input type="radio"/>
P03.13	Torque reference filter time	0.000–10.000s	0.010s	<input type="radio"/>
P03.14	Source of upper limit frequency setting of forward rotation in torque control	0: Keypad (P03.16) 1: AI1 2: AI2 3: AI3 4: Pulse frequency HDIA 5: Multi-step setting 6: Modbus/Modbus TCP communication 7: PROFIBUS/CANopen/DeviceNet/G500XLT communication 8: Ethernet communication 9: Pulse frequency HDIB 10: EtherCAT/PROFINET/EtherNet IP/G500EHT communication 11: Programmable card 12: Reserved Note: For these settings, 100% corresponds to the max. frequency.	0	<input type="radio"/>
P03.15	Source of upper limit frequency setting of reverse rotation in torque control	0: Keypad (P03.17) 1: AI1 2: AI2 3: AI3 4: Pulse frequency HDIA 5: Multi-step setting 6: Modbus/Modbus TCP communication 7: PROFIBUS/CANopen/DeviceNet/G500XLT communication	0	<input type="radio"/>

Function code	Name	Description	Default value	Modify
		8: Ethernet communication 9: Pulse frequency HDIB 10: EtherCAT/PROFINET/EtherNet IP/ G500EHT communication 11: Programmable card 12: Reserved Note: For these settings, 100% corresponds to the max. frequency.		
P03.16	Keypad limit value of upper limit frequency of forward rotation in torque control	This function code is used to set frequency limit. 100% corresponds to the max. frequency. P03.16 sets the value when P03.14=1; P03.17 sets the value when P03.15=1.	60.00Hz	<input type="radio"/>
P03.17	Max. output frequency	Setting range: 0.00Hz–P00.03 (Max. output frequency)	60.00Hz	<input type="radio"/>
P03.18	Source of upper limit setting of the torque during motoring	0: Keypad (P03.20) 1: AI1 2: AI2 3: AI3 4: Pulse frequency HDIA 5: Modbus/Modbus TCP communication 6: PROFIBUS/CANopen/DeviceNet/G500XLT communication 7: Ethernet communication 8: Pulse frequency HDIB 9: EtherCAT/PROFINET/EtherNet IP/ G500EHT communication 10: Programmable card 11: Reserved Note: For these settings, 100% corresponds to the motor rated current.	0	<input type="radio"/>
P03.19	Source of upper limit setting of brake torque	0: Keypad (P03.21) 1: AI1 2: AI2 3: AI3 4: Pulse frequency HDIA 5: Modbus/Modbus TCP communication 6: PROFIBUS/CANopen/DeviceNet/G500XLT	0	<input type="radio"/>

Function code	Name	Description	Default value	Modify
		communication 7: Ethernet communication 8: Pulse frequency HDIB 9: EtherCAT/PROFINET/EtherNet IP/ G500EHT communication 10: Programmable card 11: Reserved Note: For these settings, 100% corresponds to the motor rated current.		
P03.20	Set upper limit of the torque when motoring via keypad	This function code is used to set torque limit. Setting range: 0.0–300.0% (rated motor current)	180.0%	<input type="radio"/>
P03.21	Set upper limit of brake torque via keypad		180.0%	<input type="radio"/>
P03.22	Flux-weakening coefficient of constant-power zone	Used when asynchronous motor is in flux-weakening control. 	0.3	<input type="radio"/>
P03.23	Min. flux-weakening point of constant-power zone	P03.22 and P03.23 are valid during constant power. When motor speed is above rated speed, motor enters flux-weakening running state. The flux-weakening control coefficient can change the flux-weakening curvature, the larger the coefficient, the steeper the curve, the smaller the coefficient, the smoother the curve. Setting range of P03.22: 0.1–2.0 Setting range of P03.23: 10%–100%	20%	<input type="radio"/>
P03.24	Max. voltage limit	P03.24 sets the maximum output voltage of the inverter, which is the percentage of rated motor voltage. This value should be set according to field conditions.	100.0%	<input type="radio"/>

Function code	Name	Description	Default value	Modify
		Setting range:0.0–120.0%		
P03.25	Pre-existing time	Carry out motor pre-existing during starting to build a magnetic field inside the motor to improve the torque characteristics of motor during starting. Setting range: 0.000–10.000s	0.300s	<input type="radio"/>
P03.26	Flux-weakening proportional gain	0–8000	1000	<input type="radio"/>
P03.27	Vector control speed display	0: Display as per actual value 1: Display as per the set value	0	<input type="radio"/>
P03.28	Static friction compensation coefficient	0.0–100.0%	0.0%	<input type="radio"/>
P03.29	Corresponding frequency point of static friction	0.50– P03.31	1.00Hz	<input type="radio"/>
P03.30	High speed friction compensation coefficient	0.0–100.0%	0.0%	<input type="radio"/>
P03.31	Corresponding frequency of high speed friction torque	P03.29–400.00Hz	50.00Hz	<input type="radio"/>
P03.32	Torque control enable	0:Disable 1:Enable	0	<input checked="" type="radio"/>
P03.33	Flux weakening integral gain	0–8000	1200	<input type="radio"/>
P03.34	Flux-weakening control mode	0x000–0x112 Ones place: Control mode 0: Mode 0 1: Mode 1 2: Mode 2 Tens place: Compensation of inductance saturation coefficient 0: Enable 1: Disable Hundreds place: Compensation of current loop feedforward	0x000	<input type="radio"/>

Function code	Name	Description	Default value	Modify
		0: Enable 1: Disable		
P03.35	Control optimization setting	Ones place: Reserved 0: Reserved 1: Reserved Tens place: Reserved 0: Reserved 1: Reserved Hundreds place: ASR integral separation enabling 0: Disabled 1: Enabled Thousands place: Reserved 0: Reserved 1: Reserved Range: 0x0000–0x1111	0x0000	○
P03.36	Speed loop differential gain	0.00–10.00s	0.00s	○
P03.37	High-frequency current loop proportional coefficient	Under closed-loop vector control mode (P00.00=3) and P03.39, the current loop PI parameters are P03.09 and P03.10; above P03.39, the PI parameters are P03.37 and P03.38.	1000	○
P03.38	High-frequency current loop integral coefficient	Setting range of P03.37: 0–20000 Setting range of P03.38: 0–20000	1000	○
P03.39	Current loop high-frequency switch-over point	Setting range of P03.39: 0.0–100.0% (relative to max. frequency)	100.0%	○
P03.40	Inertia compensation enable	0: Disable 1: Enable	0	○
P03.41	Upper limit of inertia compensation torque	Limit the max. inertia compensation torque to prevent inertia compensation torque from being too large. Setting range: 0.0–150.0% (rated motor torque)	10.0%	○
P03.42	Inertia compensation filter times	Filter times of inertia compensation torque, used to smooth inertia compensation torque. Setting range: 0–10	7	○

Function code	Name	Description	Default value	Modify
P03.43	Inertia identification torque value	Due to friction force, it is required to set certain identification torque for the inertia identification to be performed properly. 0.0–100.0% (rated motor torque)	10.0%	<input type="radio"/>
P03.44	Enable inertia identification	0: No operation 1: Start identification	0	<input checked="" type="radio"/>
P03.45	Current loop proportional coefficient after autotuning	Automatic update will be performed after motor parameter autotuning. In the closed-loop vector control mode for synchronous motors, you can set the value of this function code to P03.09. Range: 0–65535 Note: Set the value to 0 if motor parameter autotuning is not performed.	0	<input type="radio"/>
P03.46	Current integral proportional coefficient after autotuning	Automatic update will be performed after motor parameter autotuning. In the closed-loop vector control mode for synchronous motors, you can set the value of this function code to P03.10. Range: 0–65535 Note: Set the value to 0 if motor parameter autotuning is not performed.	0	<input type="radio"/>

P04 group V/F control

Function code	Name	Description	Default value	Modify
P04.00	V/F curve setting of motor 1	This group of function code defines the V/F curve of motor 1 to satisfy different load characteristics needs. 0: Straight V/F curve; fit for constant-torque load 1: Multi-point V/F curve 2: Torque down V/F curve (power of 1.3) 3: Torque down V/F curve (power of 1.7) 4: Torque down V/F curve (power of 2.0) Curve 2–4 are suitable for torque-variable load of fan pump and similar equipment. Users can make adjustment based on load characteristics to achieve optimal energy-saving effect. 5: Customized V/F (V/F separation); under this mode, V is separated from f. Users can adjust f	0	<input checked="" type="radio"/>

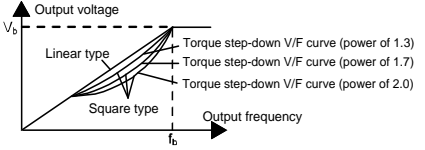
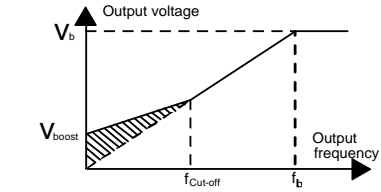
Function code	Name	Description	Default value	Modify
		<p>through the frequency reference channel set by P00.06 to change the curve characteristic, or adjust V through the voltage reference channel set by P04.27 to change the curve characteristics.</p> <p>Note: The V_b in the figure below corresponds to rated motor voltage, and f_b corresponds to rated motor frequency.</p> 		
P04.01	Torque boost of motor 1	<p>In order to compensate for low-frequency torque characteristics, users can make some boost compensation to the output voltage. P04.01 is relative to the maximum output voltage V_b. P04.02 defines the percentage of cut-off frequency of manual torque boost to the rated motor frequency f_b. Torque boost can improve the low-frequency torque characteristics of V/F. Users should select torque boost based on the load, eg, larger load requires larger torque boost, however, if the torque boost is too large, the motor will run at over-excitation, which will cause increased output current and motor heat-up, thus degrading the efficiency. When torque boost is set to 0.0%, the inverter is automatic torque boost.</p>	0.0%	○
P04.02	Motor 1 torque boost cut-off	<p>Torque boost cut-off threshold: Below this frequency threshold, the torque boost is valid, exceeding this threshold will nullify torque boost.</p> 	20.0%	○

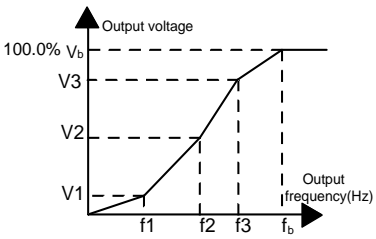
Function code	Name	Description	Default value	Modify
		Setting range of P04.01: 0.0%: (automatic) 0.1%–10.0% Setting range of P04.02: 0.0%–50.0%		
P04.03	V/F frequency point 1 of motor 1	When P04.00 =1 (multi-point V/F curve), users can set V/F curve via P04.03–P04.08.	0.00Hz	<input type="radio"/>
P04.04	V/F voltage point 1 of motor 1	V/F curve is usually set according to the characteristics of motor load.	0.0%	<input type="radio"/>
P04.05	V/F frequency point 2 of motor 1	Note: $V1 < V2 < V3$, $f1 < f2 < f3$. If low-frequency voltage is set too high, motor overheat or burnt-down may occur, and overcurrent stall or overcurrent protection may occur to the inverter.	0.00Hz	<input type="radio"/>
P04.06	V/F voltage point 2 of motor 1		0.0%	<input type="radio"/>
P04.07	V/F frequency point 3 of motor 1		0.00Hz	<input type="radio"/>
P04.08	V/F voltage point 3 of motor 1	 <p>Setting range of P04.03: 0.00Hz–P04.05 Setting range of P04.04: 0.0%–110.0% (rated voltage of motor 1) Setting range of P04.05: P04.03–P04.07 Setting range of P04.06: 0.0%–110.0% (rated voltage of motor 1) Setting range of P04.07: P04.05–P02.02 (rated frequency of asynchronous motor 1) or P04.05–P02.16 (rated frequency of synchronous motor 1) Setting range of P04.08: 0.0%–110.0% (rated voltage of motor 1)</p>	0.0%	<input type="radio"/>
P04.09	V/F slip compensation gain of motor 1	This parameter is used to compensate for the motor rotating speed change caused by load change in the SVPWM mode, and thus improve the rigidity of the mechanical characteristics of the motor. You need to calculate the rated slip frequency of the motor as follows: $\Delta f = f_b - n \times p / 60$ where f_b is the rated frequency of motor 1, corresponding to P02.02; n is the rated speed of	100.0%	<input type="radio"/>

Function code	Name	Description	Default value	Modify
		motor 1, corresponding to P02.03; p is the number of pole pairs of motor 1. 100% corresponds to the rated slip frequency Δf of motor 1. Setting range: 0.0–200.0%		
P04.10	Low-frequency oscillation control factor of motor 1	Under SVPWM control mode, the motor, especially the large-power motor may experience current oscillation during certain frequencies, which may lead to unstable motor operation, or even inverter overcurrent, users can adjust these two parameters properly to eliminate such phenomenon. Setting range of P04.10: 0–100 Setting range of P04.11: 0–100 Setting range of P04.12: 0.00Hz–P00.03 (Max. output frequency)	10	<input type="radio"/>
P04.11	High-frequency oscillation control factor of motor 1		10	<input type="radio"/>
P04.12	Oscillation control threshold of motor 1		30.00Hz	<input type="radio"/>
P04.13	V/F curve setting of motor 2	This parameter defines the V/F curve of motor 2 of the G500 series to meet various load characteristic requirements. 0: Straight V/F curve; 1: Multi-point V/F curve 2: Torque-down V/F curve (power of 1.3) 3: Torque-down V/F curve (power of 1.7) 4: Torque-down V/F curve (power of 2.0) 5: Customize V/F (V/F separation)	0	<input checked="" type="radio"/>
P04.14	Torque boost of motor 2	Note: Refer to the parameter description of P04.01 and P04.02.	0.0%	<input type="radio"/>
P04.15	Motor 2 torque boost cut-off	Setting range of P04.14: 0.0%: (automatic) 0.1%–10.0% Setting range of 0.0%–50.0% (relative to rated frequency of motor 2)	20.0%	<input type="radio"/>
P04.16	V/F frequency point 1 of motor 2	Note: Refer to the parameter description of P04.03–P04.08 Setting range of P04.16: 0.00Hz–P04.18 Setting range of P04.17: 0.0%–110.0% (rated voltage of motor 2) Setting range of P04.18: P04.16–P04.20 Setting range of P04.19: 0.0%–110.0% (rated	0.00Hz	<input type="radio"/>
P04.17	V/F voltage point 1 of motor 2		0.0%	<input type="radio"/>
P04.18	V/F frequency point 2 of motor 2		0.00Hz	<input type="radio"/>
P04.19	V/F voltage point 2 of motor 2		0.0%	<input type="radio"/>

Function code	Name	Description	Default value	Modify
P04.20	V/F frequency point 3 of motor 2	voltage of motor 2) Setting range of P04.20: P04.18–P12.02 (rated frequency of asynchronous motor 2) or P04.18–P12.16 (rated frequency of synchronous motor 2)	0.00Hz	<input type="radio"/>
P04.21	V/F voltage point 3 of motor 2	Setting range of P04.21:0.0%–110.0%(rated voltage of motor 2)	0.0%	<input type="radio"/>
P04.22	V/F slip compensation gain of motor 2	This parameter is used to compensate for the motor rotating speed change caused by load change in the SVPWM mode, and thus improve the rigidity of the mechanical characteristics of the motor. You need to calculate the rated slip frequency of the motor as follows: $\Delta f = f_b - n * p / 60$ where f_b is the rated frequency of motor 2, corresponding to P12.02; n is the rated speed of motor 2, corresponding to P12.03; p is the number of pole pairs of motor 2. 100% corresponds to the rated slip frequency Δf of motor 2. Setting range: 0.0–200.0%	0.0%	<input type="radio"/>
P04.23	Low-frequency oscillation control factor of motor 2	In the SVPWM mode, current oscillation may easily occur on motors, especially large-power motors, at some frequency, which may cause unstable running of motors or even overcurrent of inverters. You can modify this parameter to prevent current oscillation. Setting range of P04.23: 0–100 Setting range of P04.24: 0–100 Setting range of P04.25: 0.00 Hz–P00.03 (Max. output frequency)	10	<input type="radio"/>
P04.24	High-frequency oscillation control factor of motor 2		10	<input type="radio"/>
P04.25	Oscillation control threshold of motor 2		30.00Hz	<input type="radio"/>
P04.26	Energy-saving run	0: No action 1: Automatic energy-saving operation Under light-load state, the motor can adjust the output voltage automatically to achieve energy-saving purpose	0	<input checked="" type="radio"/>
P04.27	Channel of voltage setting	0: Keypad; output voltage is determined by P04.28 1: A11	0	<input type="radio"/>

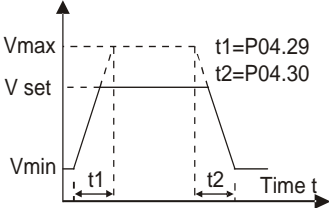
Function code	Name	Description	Default value	Modify
		2: AI2 3: AI3 4: HDIA 5: Multi-step (the set value is determined by P10 group) 6: PID 7: Modbus/Modbus TCP communication 8: PROFIBUS/CANopen/DeviceNet/ G500XLT communication 9: Ethernet communication 10: HDIB 11: EtherCAT/PROFINET/EthernetIP/G500ETH communication 12: PLC programmable card 13: Reserved		
P04.28	Set voltage value via keypad	When the channel for voltage setting is set to "keypad", the value of this function code is digital voltage set value. Setting range: 0.0%–100.0%	100.0%	<input type="radio"/>
P04.29	Voltage increase time	Voltage increase time means the time needed from outputting the min. voltage to accelerating to output the max. voltage.	5.0s	<input type="radio"/>
P04.30	Voltage decrease time	Voltage decrease time means the time needed from outputting max. voltage to outputting the min. voltage Setting range: 0.0–3600.0s	5.0s	<input type="radio"/>
P04.31	Output max. voltage	Set the upper/lower limit value of output voltage.	100.0%	<input checked="" type="radio"/>
P04.32	Output min. voltage	 <p>Setting range of P04.31: P04.32–100.0% (rated motor voltage) Setting range of P04.32: 0.0%–P04.31</p>	0.0%	<input checked="" type="radio"/>
P04.33	Flux-weakening coefficient in the	1.00–1.30	1.00	<input type="radio"/>

Function code	Name	Description	Default value	Modify
	constant power zone			
P04.34	Input current 1 in synchronous motor VF control	When the synchronous motor VF control mode is enabled, this parameter is used to set the reactive current of the motor when the output frequency is lower than the frequency set in P04.36. Setting range: -100.0%→+100.0% (of the rated current of the motor)	20.0%	○
P04.35	Input current 2 in synchronous motor VF control	When the synchronous motor VF control mode is enabled, this parameter is used to set the reactive current of the motor when the output frequency is higher than the frequency set in P04.36. Setting range: -100.0%→+100.0% (of the rated current of the motor)	10.0%	○
P04.36	Frequency threshold for input current switching in synchronous motor VF control	When the synchronous motor VF control mode is enabled, this parameter is used to set the frequency threshold for the switching between input current 1 and input current 2. Setting range: 0.0%–200.0% (of the motor rated frequency)	20.0%	○
P04.37	Reactive current closed-loop proportional coefficient in synchronous motor VF	When the synchronous motor VF control mode is enabled, this parameter is used to set the proportional coefficient of the reactive current closed-loop control. Setting range: 0–3000	50	○
P04.38	Reactive current closed-loop integral time in synchronous motor VF control	When the synchronous motor VF control mode is enabled, this parameter is used to set the integral coefficient of the reactive current closed-loop control. Setting range: 0–3000	30	○
P04.39	Reactive current closed-loop output limit in synchronous motor VF control	When the synchronous motor VF control mode is enabled, this parameter is used to set the output limit of the reactive current in the closed-loop control. A greater value indicates a higher reactive closed-loop compensation voltage and higher output power of the motor. In general, you do not need to modify this	8000	○

Function code	Name	Description	Default value	Modify
		parameter. Setting range: 0–16000		
P04.40	Enable/disable IF mode for asynchronous motor 1	0: Disabled 1: Enabled	0	☉
P04.41	Current setting in IF mode for asynchronous motor 1	When IF control is adopted for asynchronous motor 1, this parameter is used to set the output current. The value is a percentage in relative to the rated current of the motor. Setting range: 0.0–200.0%	120.0%	○
P04.42	Proportional coefficient in IF mode for asynchronous motor 1	When IF control is adopted for asynchronous motor 1, this parameter is used to set the proportional coefficient of the output current closed-loop control. Setting range: 0–5000	350	○
P04.43	Integral coefficient in IF mode for asynchronous motor 1	When IF control is adopted for asynchronous motor 1, this parameter is used to set the inetgral coefficient of the output current closed-loop control. Setting range: 0–5000	150	○
P04.44	Frequency threshold for switching off IF mode for asynchronous motor 1	When IF control is adopted for asynchronous motor 1, this parameter is used to set the frequency threshold for switching off the output current closed-loop control. When the frequency is lower than the value of this parameter, the current closed-loop control in the IF control mode is enabled; and when the frequency is higher than that, the current closed-loop control in the IF control mode is disabled. Setting range: 0.00–20.00 Hz	10.00Hz	○
P04.45	Enable/disable IF mode for asynchronous motor 2	0: Disabled 1: Enabled	0	☉
P04.46	Current setting in IF mode for asynchronous motor 2	When IF control is adopted for asynchronous motor 2, this parameter is used to set the output current. The value is a percentage in relative to the rated current of the motor. Setting range: 0.0–200.0%	120.0%	○

Function code	Name	Description	Default value	Modify
P04.47	Proportional coefficient in IF mode for asynchronous motor 2	When IF control is adopted for asynchronous motor 2, this parameter is used to set the proportional coefficient of the output current closed-loop control. Setting range: 0–5000	350	<input type="radio"/>
P04.48	Integral coefficient in IF mode for asynchronous motor 2	When IF control is adopted for asynchronous motor 2, this parameter is used to set the integral coefficient of the output current closed-loop control. Setting range: 0–5000	150	<input type="radio"/>
P04.49	Frequency threshold for switching off IF mode for asynchronous motor 2	When IF control is adopted for asynchronous motor 2, this parameter is used to set the frequency threshold for switching off the output current closed-loop control. When the frequency is lower than the value of this parameter, the current closed-loop control in the IF control mode is enabled; and when the frequency is higher than that, the current closed-loop control in the IF control mode is disabled. Setting range: 0.00–20.00 Hz	10.00Hz	<input type="radio"/>
P04.50	End frequency point for switching off IF mode for asynchronous motor 1	P04.44–P00.03	25.00Hz	<input type="radio"/>
P04.51	End frequency point for switching off IF mode for asynchronous motor 2	P04.49–P00.03	25.00Hz	<input type="radio"/>

P05 group Input terminals

Function code	Name	Description	Default value	Modify
P05.00	HDI input type	0x00–0x11 Ones: HDIA input type 0: HDIA is high-speed pulse input 1: HDIA is digital input Tens: HDIB input type 0: HDIB is high-speed pulse input	0x00	<input checked="" type="radio"/>

Function code	Name	Description	Default value	Modify
		1: HDIB is digital input		
P05.01	Function of S1 terminal	0: No function 1: Forward running	1	⊙
P05.02	Function of S2 terminal	2: Reverse running 3: 3-wire control/Sin	4	⊙
P05.03	Function of S3 terminal	4: Forward jogging 5: Reverse jogging	7	⊙
P05.04	Function of S4 terminal	6: Coast to stop 7: Fault reset	0	⊙
P05.05	Function of HDIA terminal	8: Running pause 9: External fault input	0	⊙
P05.06	Function of HDIB terminal	10: Frequency increase (UP) 11: Frequency decrease (DOWN) 12: Clear frequency increase/decrease setting 13: Switch-over between setting sources A and B 14: Switch-over between combination setting mode and setting source A 15: Switch-over between combination setting mode and setting source B 16: Multi-step speed terminal 1 17: Multi-step speed terminal 2 18: Multi-step speed terminal 3 19: Multi-step speed terminal 4 20: Multi-step speed pause 21: Acceleration/deceleration time selection 1 22: Acceleration/deceleration time selection 2 23: Simple PLC stop reset 24: Simple PLC pause 25: PID control pause 26: Wobbling frequency pause 27: Wobbling frequency reset 28: Counter reset 29: Switching between speed control and torque control 30: Acceleration/deceleration disabled 31: Counter trigger 32: Reserved 33: Clear frequency increase/decrease setting	0	⊙

Function code	Name	Description	Default value	Modify
		temporarily 34: DC brake 35: Switching between motor 1 and motor 2 36: Command switches to keypad 37: Command switches to terminal 38: Command switches to communication 39: Pre-existing command 40: Zero out power consumption quantity 41: Maintain power consumption quantity 42: Switching the upper torque limit setting mode to keypad 43: Position reference point input (only valid for S2, S3 and S4) 44: Spindle orientation disabled 45: Spindle zeroing/local position zeroing 46: Spindle zero-position setting 1 47: Spindle zero-position setting 2 48: Spindle indexing setting 1 49: Spindle indexing setting 2 50: Spindle indexing setting 3 51: Terminal for switching between position control and speed control 52: Disable pulse input 53: Eliminate position deviation 54: Switch position proportional gain 55: Enable cyclic digital positioning 56: Emergency stop 57: Motor overtemperature fault input 59: Switch to V/F control 60: Switch to FVC control 61: PID polarity switch-over 66: Zero out encoder counting 67: Pulse increase 68: Enable pulse superimposition 69: Pulse decrease 70: Electronic gear selection 71: Switch to the master 72: Switch to the slave 73: Reset the roll diameter		

Function code	Name	Description	Default value	Modify
		74: Switch winding/unwinding 75: Pre-drive 76: Disable roll diameter calculation 77: Clear alarm display 78: Manual braking 79: Trigger forced feeding interrupt 80: Initial roll diameter 1 81: Initial roll diameter 2 82: Trigger fire mode control 83: Switch tension PID parameters 84–95: Reserved		
P05.07	Reserved			
P05.08	Polarity of input terminal	This function code is used to set the polarity of input terminals. When the bit is set to 0, input terminal polarity is positive; When the bit is set to 1, input terminal polarity is negative; 0x00–0x3F	0x00	○
P05.09	Digital filter time	Set the sampling filtering time of the S1–S4, HDIA, and .HDIB terminals. In cases where interference is strong, increase the value of this parameter to avoid malfunction. 0.000–1.000s	0.010s	○
P05.10	Virtual terminal setting	0x00–0x3F (0: disable, 1: enable) BIT0: S1 virtual terminal BIT1: S2 virtual terminal BIT2: S3 virtual terminal BIT3: S4 virtual terminal BIT4: HDIA virtual terminal BIT5: HDIB virtual terminal	0x00	◎
P05.11	2/3 Wire control mode	This function code is used to set the 2/3 Wire control mode. 0: 2-Wire control 1; integrate enabling function with direction. This mode is the most popular dual-line mode. Direction of motor rotation is determined by the defined FWD/REV terminal command.	0	◎

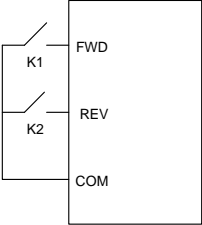
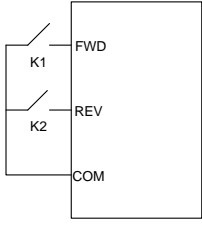
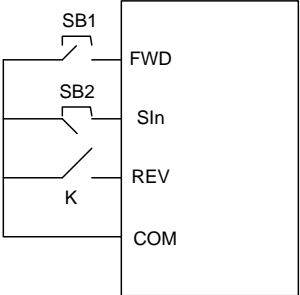
Function code	Name	Description	Default value	Modify																														
		 <table border="1" data-bbox="626 212 805 437"> <tr> <td>FWD</td> <td>REV</td> <td>Running command</td> </tr> <tr> <td>OFF</td> <td>OFF</td> <td>Stop</td> </tr> <tr> <td>ON</td> <td>OFF</td> <td>Forward running</td> </tr> <tr> <td>OFF</td> <td>ON</td> <td>Reverse running</td> </tr> <tr> <td>ON</td> <td>ON</td> <td>Hold</td> </tr> </table> <p>1: 2-wire control 2; separate enabling function with direction. In this mode, the defined FWD is enabling terminal, and the direction is determined by the state of REV.</p>  <table border="1" data-bbox="626 571 805 796"> <tr> <td>FWD</td> <td>REV</td> <td>Running command</td> </tr> <tr> <td>OFF</td> <td>OFF</td> <td>Stop</td> </tr> <tr> <td>ON</td> <td>OFF</td> <td>Forward running</td> </tr> <tr> <td>OFF</td> <td>ON</td> <td>Stop</td> </tr> <tr> <td>ON</td> <td>ON</td> <td>Reverse running</td> </tr> </table> <p>2: 3-wire control 1; This mode defines Sin as enabling terminal, and the running command is generated by FWD, the direction is controlled by REV. During running, the Sin terminal should be closed, and terminal FWD generates a rising edge signal, then the inverter starts to run in the direction set by the state of terminal REV; the inverter should be stopped by disconnecting terminal Sin.</p>  <p>The direction control during running is shown as follows.</p>	FWD	REV	Running command	OFF	OFF	Stop	ON	OFF	Forward running	OFF	ON	Reverse running	ON	ON	Hold	FWD	REV	Running command	OFF	OFF	Stop	ON	OFF	Forward running	OFF	ON	Stop	ON	ON	Reverse running		
FWD	REV	Running command																																
OFF	OFF	Stop																																
ON	OFF	Forward running																																
OFF	ON	Reverse running																																
ON	ON	Hold																																
FWD	REV	Running command																																
OFF	OFF	Stop																																
ON	OFF	Forward running																																
OFF	ON	Stop																																
ON	ON	Reverse running																																

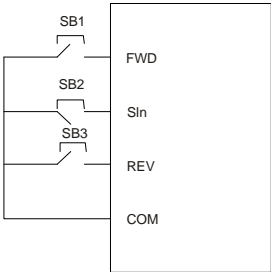
Function code	Name	Description				Default value	Modify
		Sn	REV	Previous running direction	Current running direction		
		ON	OFF→ON	Forward	Reverse		
				Reverse	Forward		
		ON	ON→OFF	Reverse	Forward		
				Forward	Reverse		
		ON→OFF	ON	Decelerate to stop			
			OFF				
		<p>Sn: 3-wire control/Sn, FWD: Forward running, REV: Reverse running</p> <p>3: 3-wire control 2; This mode defines Sn as enabling terminal. The running command is generated by FWD or REV, and they control the running direction. During running, the terminal Sn should be closed, and terminal FWD or REV generates a rising edge signal to control the running and direction of inverter; the inverter should be stopped by disconnecting terminal Sn.</p>					
							
		Sn	FWD	REV	Running direction		
		ON	OFF→ON	ON	Forward		
				OFF	Forward		
		ON	ON	OFF→ON	Reverse		
			OFF		Reverse		
		ON→OFF			Decelerate to stop		
		<p>Sn: 3-wire control/Sn, FWD: Forward running, REV: Reverse running</p>					

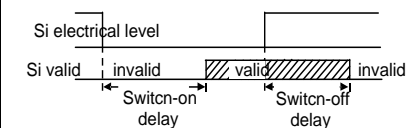
Function code	Name	Description	Default value	Modify	
		Note: For dual-line running mode, when FWD/REV terminal is valid, if the inverter stops due to stop command given by other sources, it will not run again after the stop command disappears even if the control terminals FWD/REV are still valid. To make the inverter run again, users need to trigger FWD/REV again, eg, PLC single-cycle stop, fixed-length stop, and valid STOP/RST stop during terminal control. (see P07.04).			
P05.12	S1 terminal switch-on delay	<p>These function codes define corresponding delay of the programmable input terminals during level variation from switch-on to switch-off .</p>  <p>Setting range: 0.000–50.000s</p>	0.000s	<input type="radio"/>	
P05.13	S1 terminal switch-off delay		0.000s	<input type="radio"/>	
P05.14	S2 terminal switch-on delay		0.000s	<input type="radio"/>	
P05.15	S2 terminal switch-off delay		0.000s	<input type="radio"/>	
P05.16	S3 terminal switch-on delay		0.000s	<input type="radio"/>	
P05.17	S3 terminal switch-off delay		0.000s	<input type="radio"/>	
P05.18	S4 terminal switch-on delay		0.000s	<input type="radio"/>	
P05.19	S4 terminal switch-off delay		0.000s	<input type="radio"/>	
P05.20	HDIA terminal switch-on delay		Note: After a virtual terminal is enabled, the state of the terminal can be changed only in communication mode. The communication address is 0x200A.	0.000s	<input type="radio"/>
P05.21	HDIA terminal switch-off delay			0.000s	<input type="radio"/>
P05.22	HDIB terminal switch-on delay			0.000s	<input type="radio"/>
P05.23	HDIB terminal switch-off delay		0.000s	<input type="radio"/>	
P05.24	Lower limit value of AI1		These function codes define the relation between analog input voltage and corresponding set value of analog input. When the analog input voltage exceeds the range of	0.00V	<input type="radio"/>
P05.25	Corresponding setting of lower	0.0%		<input type="radio"/>	

Function code	Name	Description	Default value	Modify
	limit of AI1	max./min. input, the max. input or min. input will be adopted during calculation.		
P05.26	Upper limit value of AI1	When analog input is current input, 0–20mA current corresponds to 0–10V voltage.	10.00V	<input type="radio"/>
P05.27	Corresponding setting of upper limit of AI1	In different applications, 100% of analog setting corresponds to different nominal values.	100.0%	<input type="radio"/>
P05.28	Input filter time of AI1	The figure below illustrates several settings.	0.030s	<input type="radio"/>
P05.29	Lower limit value of AI2		-10.00V	<input type="radio"/>
P05.30	Corresponding setting of lower limit of AI2		-100.0%	<input type="radio"/>
P05.31	Intermediate value 1 of AI2		0.00V	<input type="radio"/>
P05.32	Corresponding setting of intermediate value 1 of AI2	Input filter time: Adjust the sensitivity of analog input, increase this value properly can enhance the anti-interference capacity of analog variables; however, it will also degrade the sensitivity of analog input.	0.0%	<input type="radio"/>
P05.33	Intermediate value 2 of AI2	Note: AI1 can support 0–10V/0–20mA input, when AI1 selects 0–20mA input; the corresponding voltage of 20mA is 10V; AI2 supports -10V–+10V input.	0.00V	<input type="radio"/>
P05.34	Corresponding setting of intermediate value 2 of AI2	Setting range of P05.24: 0.00V–P05.26 Setting range of P05.25: -100.0%–100.0%	0.0%	<input type="radio"/>
P05.35	Upper limit value of AI2	Setting range of P05.26: P05.24–10.00V Setting range of P05.27: -100.0%–100.0%	10.00V	<input type="radio"/>
P05.36	Corresponding setting of upper limit of AI2	Setting range of P05.28: 0.000s–10.000s Setting range of P05.29: -10.00V–P05.31 Setting range of P05.30: -100.0%–100.0%	100.0%	<input type="radio"/>
P05.37	Input filter time of AI2	Setting range of P05.31: P05.29–P05.33 Setting range of P05.32: -100.0%–100.0% Setting range of P05.33: P05.31–P05.35 Setting range of P05.34: -100.0%–100.0% Setting range of P05.35: P05.33–10.00V Setting range of P05.36: -100.0%–100.0% Setting range of P05.37: 0.000s–10.000s	0.030s	<input type="radio"/>

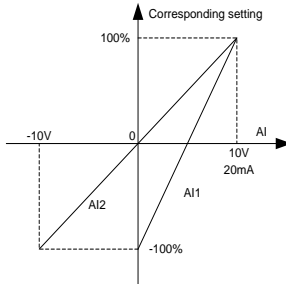

Function code	Name	Description	Default value	Modify
P05.38	HDIA high-speed pulse input function	0: Set input via frequency 1: Reserved 2: Input via encoder, used in combination with HDIB	0	☉
P05.39	Lower limit frequency of HDIA	0.000 KHz – P05.41	0.000 KHz	○
P05.40	Corresponding setting of lower limit frequency of HDIA	-100.0%–100.0%	0.0%	○
P05.41	Upper limit frequency of HDIA	P05.39 –50.000KHz	50.000 KHz	○
P05.42	Corresponding setting of upper limit frequency of HDIA	-100.0%–100.0%	100.0%	○
P05.43	HDIA frequency input filter time	0.000s–10.000s	0.030s	○
P05.44	HDIB high-speed pulse input function selection	0: Set input via frequency 1: Reserved 2: Encoder input, it should be used in combination with HDIA	0	☉
P05.45	Lower limit frequency of HDIB	0.000 kHz – P05.47	0.000 kHz	○
P05.46	Corresponding setting of lower limit frequency of HDIB	-100.0%–100.0%	0.0%	○
P05.47	Upper limit frequency of HDIB	P05.45 –50.000kHz	50.000 kHz	○
P05.48	Corresponding setting of upper limit frequency of HDIB	-100.0%–100.0%	100.0%	○
P05.49	HDIB frequency input filter time	0.000s–10.000s	0.030s	○
P05.50	AI1 input signal type	0: Voltage type 1: Current type Note: You can set the AI1 input signal type through the corresponding function code.	0	☉

Function code	Name	Description	Default value	Modify
P05.51–P05.52	Reserved			

P06 group Output terminals

Function code	Name	Description	Default value	Modify
P06.00	HDO output type	0: Open collector high-speed pulse output: Max. frequency of the pulse is 50.00kHz. For details about the related functions, see P06.27–P06.31. 1: Open collector output: For details about the related functions, see P06.02.	0	☉
P06.01	Y output selection	0: Invalid	0	○
P06.02	HDO output selection	1: In running 2: In forward running 3: In reverse running	0	○
P06.03	Relay RO1 output selection	4: In jogging 5: Inverter fault	1	○
P06.04	Relay RO2 output selection	6: Frequency level detection FDT1 7: Frequency level detection FDT2 8: Frequency reached 9: Running at zero speed 10: Reach upper limit frequency 11: Reach lower limit frequency 12: Ready to run 13: In pre-existing 14: Overload pre-alarm 15: Underload pre-alarm 16: Simple PLC stage completed 17: Simple PLC cycle completed 18: Reach set counting value 19: Reach designated counting value 20: External fault is valid 21: Reserved 22: Reach running time 23: Virtual terminal output of Modbus/Modbus TCP communication 24: Virtual terminal output of POROFIBUS /CANopen communication 25: Virtual terminal output of Ethernet	5	○

Function code	Name	Description	Default value	Modify
		communication 26: DC bus voltage established 27: z pulse output 28: During pulse superposition 29: STO action 30: Positioning completed 31: Spindle zeroing completed 32: Spindle scale-division completed 33: Speed limit reached in torque control 34–35: Reserved 36: Speed/position control switch-over completed 37–40: Reserved 41: Y1 from the programmable card 42: Y2 from the programmable card 43: HDO from the programmable card 44: RO1 from the programmable card 45: RO2 from the programmable card 46: RO3 from the programmable card 47: RO4 from the programmable card 48: EC PT100 detected OH pre-alarm 49: EC PT1000 detected OH pre-alarm 50: AI/AO detected OH pre-alarm 51: Stopped or running at zero speed 52: Disconnection detected in tension control 53: Roll diameter setting reached 54: Max. roll diameter reached 55: Min. roll diameter reached 56: Fire control mode enabled 57: S1 status 58: S2 status 59: S3 status 60: S4 status 61: HDIA status 62: HDIB status 63: Reserved		
P06.05	Output terminal polarity selection	This function code is used to set the polarity of output terminals. When the bit is set to 0, the input terminal polarity is positive;	0x00	○

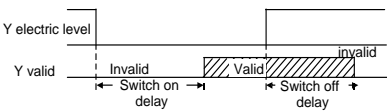
Function code	Name	Description	Default value	Modify								
		When the bit is set to 1, the input terminal polarity is negative. <table border="1" style="margin-left: auto; margin-right: auto;"> <tr> <td>BIT3</td> <td>BIT2</td> <td>BIT1</td> <td>BIT0</td> </tr> <tr> <td>RO2</td> <td>RO1</td> <td>HDO</td> <td>Y</td> </tr> </table> Setting range: 0x00–0x0F	BIT3	BIT2	BIT1	BIT0	RO2	RO1	HDO	Y		
BIT3	BIT2	BIT1	BIT0									
RO2	RO1	HDO	Y									
P06.06	Y switch-on delay	This function code defines the corresponding delay of the level variation from switch-on to switch-off. 	0.000s	○								
P06.07	Y switch-off delay		0.000s	○								
P06.08	HDO switch-on delay		0.000s	○								
P06.09	HDO switch-off delay		0.000s	○								
P06.10	Relay RO1 switch-on delay		0.000s	○								
P06.11	Relay RO1 switch-off delay		Setting range: 0.000–50.000s	0.000s	○							
P06.12	Relay RO2 switch-on delay		Note: P06.08 and P06.09 are valid only when P06.00=1.	0.000s	○							
P06.13	Relay RO2 switch-off delay			0.000s	○							
P06.14	AO1 output selection		0: Running frequency	0	○							
P06.15	Reserved variables		1: Set frequency	0	○							
			2: Ramps reference frequency									
P06.16	HDO high-speed pulse output		3: Running speed	0	○							
			4: Output current (relative to inverter)									
		5: Output current (relative to motor)										
		6: Output voltage										
		7: Output power										
		8: Set torque value										
		9: Output torque										
		10: AI1 input value										
		11: AI2 input value										
		12: AI3 input value										
		13: Input value of high-speed pulse HDIA										
		14: Set value 1 of Modbus/Modbus TCP communication										
		15: Set value 2 of Modbus/Modbus TCP communication										
		16: Set value 1 of										

Function code	Name	Description	Default value	Modify
		PROFIBUS/CANopen/DeviceNet/G500SLT communication 17: Set value 2 of PROFIBUS/CANopen/DeviceNet/G500XLT communication 18: Set value 1 of Ethernet communication 19: Set value 2 of Ethernet communication 20: Input value of high-speed pulse HDIB 21: Reserved 22: Torque current (bipolar, 100% corresponds to 10V) 23: Existing current (100% corresponds to 10V) 24: Set frequency (bipolar) 25: Ramps reference frequency (bipolar) 26: Running speed (bipolar) 27: Set value 2 of EtherCAT/PROFINET/EtherNet IP/ G500ETH communication 28: AO1 from the programmable card (0–1000) 29: AO2 from the programmable card (0–1000) 30: Running speed (100% corresponds to twice the motor rated synchronous speed) 31: Output torque (Actual value, 100% corresponds to twice the motor rated torque) 32: AI/AO temperature detection output 33–63: Reserved		
P06.17	Lower limit of AO1 output	Above function codes define the relation between output value and analog output. When the output value exceeds the set max./min. output range, the upper/lower limit of output will be adopted during calculation. When analog output is current output, 1mA corresponds to 0.5V voltage. In different applications, 100% of output value corresponds to different analog outputs.	0.0%	<input type="radio"/>
P06.18	Corresponding AO1 output of lower limit		0.00V	<input type="radio"/>
P06.19	Upper limit of AO1 output		100.0%	<input type="radio"/>
P06.20	Corresponding AO1 output of upper limit		10.00V	<input type="radio"/>
P06.21	AO1 output filter time		0.000s	<input type="radio"/>

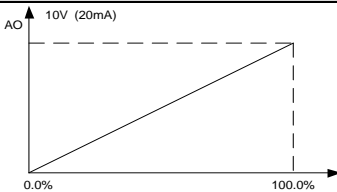
Function code	Name	Description	Default value	Modify
		 <p>Setting range of P06.17: -100.0%~P06.19 Setting range of P06.18: 0.00V~10.00V Setting range of P06.19: P06.17~100.0% Setting range of P06.20: 0.00V~10.00V Setting range of P06.21: 0.000s~10.000s</p>		
P06.22	Reserved			
P06.23	PTC constant output current setting	0.000~20.000mA	4.000mA	<input type="radio"/>
P06.24	PTC resistance alarm threshold	0~60000Ω	750Ω	<input type="radio"/>
P06.25	PTC resistance alarm recovery threshold	0~60000Ω	150Ω	<input type="radio"/>
P06.26	Actual PTC resistance	0~60000Ω	0Ω	<input checked="" type="radio"/>
P06.27	Lower limit of HDO output	-100.0%~P06.29	0.00%	<input type="radio"/>
P06.28	Corresponding HDO output of lower limit	0.00~50.00kHz	0.00kHz	<input type="radio"/>
P06.29	Upper limit of HDO output	P06.27~100.0%	100.0%	<input type="radio"/>
P06.30	Corresponding HDO output of upper limit	0.00~50.00kHz	50.00 kHz	<input type="radio"/>
P06.31	HDO output filter time	0.000s~10.000s	0.000s	<input type="radio"/>
P06.32	Reserved			
P06.33	Frequency reach detection value	0~P00.03	1.00Hz	<input type="radio"/>

Function code	Name	Description	Default value	Modify
P06.34	Frequency reach detection time	0–3600.0s	0.5s	○

P07 group HMI

Function code	Name	Description	Default value	Modify
P07.00	User password	0–65535 Set to any non-zero value to enable password protection. 00000: Clear previous user password and disable password protection. After user password becomes valid, if an incorrect password is entered, users will be denied entry. It is imperative that you remember your user password. Password protection will be effective one minute after exiting function code edit state, and it will display "0.0.0.0.0". If users press PRG/ESC key to enter function code edit state again, users need to input the correct password. Note: Restoring to default values will clear user password. Use this function with caution.	0	○
P07.01	Function parameter copying	0–4 0: Disabled 1: Upload loc function parameter to keypad 2: Download all function parameter from keypad 3: Download non-motor parameters from keypad 4: Download motor parameters from keypad	0	◎
P07.02	Function of keys	Range: 0x00–0x27 Ones: Function selection of QUICK/JOG key 0: No function 1: Jogging 2: Reserved 3: Forward/reverse rotation switch-over 4: Clear UP/DOWN setting 5: Coast to stop 6: Switch over the running command reference	0x01	◎

Function code	Name	Description	Default value	Modify
		mode in sequence 7: Reserved Tens: Reserved		
P07.03	Running command channel switch-over sequence of QUICK key	When P07.02=6, set the switch-over sequence of running command channel. 0: keypad control→terminal control→communication control 1: keypad control←→terminal control 2: keypad control←→communication control 3: terminal control←→communication control	0	○
P07.04	Stop function selection of STOP/RST key	Valid selection of stop function of STOP/RST. For fault reset, STOP/RST is valid under any situation. 0: valid for panel control only 1: valid for both panel and terminal control 2: valid for both panel and communication control 3: valid for all control modes	0	○
P07.05	Parameter selection 1 displayed in running state	0x0000–0xFFFF BIT0: Running frequency (Hz on) BIT1: Set frequency (Hz blinking) BIT2: Bus voltage (V on) BIT3: Output voltage (V on) BIT4: Output current (A on) BIT5: Running speed (rpm on) BIT6: Output frequency (% on) BIT7: Output torque (% on) BIT8: PID reference value (% blinking) BIT9: PID feedback value (% on) BIT10: Input terminal status BIT11: Output terminal status BIT12: Torque setting (% on) BIT13: Pulse counting value BIT14: Motor overload percentage (% on) BIT15: PLC and the current step of multi-step speed	0x03FF	○
P07.06	Parameter selection 2 displayed in	0x0000–0xFFFF BIT0: AI1 (V on) BIT1: AI2 value (V on)	0x0000	○

Function code	Name	Description	Default value	Modify
	running state	BIT2: AI3 value (V on) BIT3: High-speed pulse HDIA frequency BIT4: High-speed pulse HDIB frequency BIT5: Inverter overload percentage (% on) BIT6: Ramp frequency reference (Hz on) BIT7: Linear speed BIT8: AC incoming current BIT9: Upper limit frequency BIT10–15: Reserved		
P07.07	Parameter selection displayed in stop state	0x0000–0xFFFF BIT0: Set frequency (Hz on) BIT1: Bus voltage (V on) BIT2: Input terminal status BIT3: Output terminal status BIT4: PID reference value (% blinking) BIT5: PID feedback value (% on) BIT6: Torque setting (% on) BIT7: AI1 value (V on) BIT8: AI2 value (V on) BIT9: AI3 value (V on) BIT10: High-speed pulse HDIA frequency BIT11: High-speed pulse HDIB frequency BIT12: Count value BIT13: PLC and the current step of multi-step speed BIT14: Upper limit frequency BIT15: Reserved	0x00FF	○
P07.08	Frequency display coefficient	0.01–10.00 Display frequency=running frequency× P07.08	1.00	○
P07.09	Speed display coefficient	0.1–999.9% Mechanical speed=120×display running frequency×P07.09/number of motor pole pairs	100.0%	○
P07.10	Linear speed display coefficient	0.1–999.9% Linear speed=mechanical speed×P07.10	1.0%	○
P07.11	Temperature of rectifier bridge module	-20.0–120.0°C	/	●
P07.12	Temperature of inverter module	-20.0–120.0°C	/	●

Function code	Name	Description	Default value	Modify
P07.13	Software version of control board	1.00–655.35	/	●
P07.14	Accumulated running time	0–65535h	/	●
P07.15	High bit of inverter power consumption	Displays the power consumption of the inverter. Inverter power consumption=P07.15×1000+P07.16	/	●
P07.16	Low bit of inverter power consumption	Setting range of P07.15: 0–65535 kWh (×1000) Setting range of P07.16: 0.0–999.9 kWh	/	●
P07.17	Inverter model	0x0000–0xFFFF Bit0–bit3: G type or P type 0x0: G type 0x1: P type Bit4–bit11: Chip type and manufacturer 0x00: DSP(TI) 0x01–0x20: Reserved 0x21: MCU(ST) 0x22–0xFF: Reserved Bit12–bit15: Inverter series 0x0:Reserved 0x1: Reserved 0x2: G500 0x3: Reserved 0x4–0xF: Reserved	Depend on model	●
P07.18	Rated power of inverter	0.4–3000.0kW (4023HP)	0.4kW	●
P07.19	Rated voltage of inverter	50–1200V	380V	●
P07.20	Rated current of inverter	0.1–6000.0A	0.1A	●
P07.21	Factory barcode 1	0x0000–0xFFFF	0xFFFF	●
P07.22	Factory barcode 2	0x0000–0xFFFF	0xFFFF	●
P07.23	Factory barcode 3	0x0000–0xFFFF	0xFFFF	●
P07.24	Factory barcode 4	0x0000–0xFFFF	0xFFFF	●
P07.25	Factory barcode 5	0x0000–0xFFFF	0xFFFF	●
P07.26	Factory barcode 6	0x0000–0xFFFF	0xFFFF	●
P07.27	Current fault	0: No fault	/	●

Function code	Name	Description	Default value	Modify
P07.28	Last fault	1: Inverter unit U phase protection (OUT1)	/	●
P07.29	Second to last fault	2: Inverter unit V phase protection (OUT2)	/	●
P07.30	Third to last fault	3: Inverter unit W phase protection (OUT3)	/	●
P07.31	Fourth to last fault	4: Overcurrent during acceleration (OC1)	/	●
P07.32	Fifth to last fault	5: Overcurrent during deceleration (OC2)	/	●
		6: Overcurrent during constant speed (OC3)		
		7: Overvoltage during acceleration (OV1)		
		8: Overvoltage during deceleration (OV2)		
		9: Overvoltage during constant speed (OV3)		
		10: Bus undervoltage fault (UV)		
		11: Motor overload (OL1)		
		12: Inverter overload (OL2)		
		13: Phase loss on input side (SPI)		
		14: Phase loss on output side (SPO)		
		15: Rectifier module overheat (OH1)		
		16: Inverter module overheat (OH2)		
		17: External fault (EF)		
		18: 485 communication fault (CE)		
		19: Current detection fault (ItE)		
		20: Motor autotuning fault (tE)		
		21: EEPROM operation fault (EEP)		
		22: PID feedback offline fault (PIDE)		
		23: Brake unit fault (bCE)		
		24: Running time reached (END)		
		25: Electronic overload (OL3)		
		26: Keypad communication error (PCE)		
		27: Parameter upload error (UPE)		
		28: Parameter download error (DNE)		
		29: Profibus communication fault (E-DP)		
		30: Ethernet communication fault (E-NET)		
		31: CANopen communication fault (E-CAN)		
		32: To-ground short-circuit fault 1 (ETH1)		
		33: To-ground short-circuit fault 2 (ETH2)		
		34: Speed deviation fault (dEu)		
		35: Mal-adjustment fault (STo)		
		36: Underload fault (LL)		
		37: Encoder offline fault (ENC1O)		
38: Encoder reversal fault (ENC1D)				
39: Encoder Z pulse offline fault (ENC1Z)				

Function code	Name	Description	Default value	Modify
		40: Safe torque off (STO)		
		41: Channel H1 safety circuit exception (STL1)		
		42: Channel H2 safety circuit exception (STL2)		
		43: Channel H1 and H2 exception (STL3)		
		44: Safety code FLASH CRC fault (CrCE)		
		45: PLC card customized fault 1 (P-E1)		
		46: PLC card customized fault 2 (P-E2)		
		47: PLC card customized fault 3 (P-E3)		
		48: PLC card customized fault 4 (P-E4)		
		49: PLC card customized fault 5 (P-E5)		
		50: PLC card customized fault 6 (P-E6)		
		51: PLC card customized fault 7 (P-E7)		
		52: PLC card customized fault 8 (P-E8)		
		53: PLC card customized fault 9 (P-E9)		
		54: PLC card customized fault 10 (P-E10)		
		55: Repetitive expansion card type fault (E-Err)		
		56: Encoder UVW loss fault (ENCUV)		
		57: Profibus communication fault (E-PN)		
		58: CANopen communication fault (ESCAN)		
		59: Motor over-temperature fault (OT)		
		60: Card slot 1 card identification failure (F1-Er)		
		61: Card slot 2 card identification failure (F2-Er)		
		62: Card slot 3 card identification failure (F3-Er)		
		63: Card slot 1 card communication timeout fault (C1-Er)		
		64: Card slot 2 card communication timeout fault (C2-Er)		
		65: Card slot 3 card communication timeout fault (C3-Er)		
		66: EtherCAT communication fault (E-CAT)		
		67: Bacnet communication fault (E-BAC)		
		68: DeviceNet communication fault (E-DEV)		
		69: Master-slave synchronous CAN slave fault (S-Err)		
		70: EC PT100 detected overheating (OtE1)		
		71: EC PT1000 detected overheating (OtE2)		
		72: EtherNet/IP communication timeout (E-EIP)		
		73: No upgrade bootloader (E-PAO)		
		74: AI1 disconnected (E-AI1)		

Function code	Name	Description	Default value	Modify
		75: AI2 disconnected (E-AI2) 76: AI3 disconnected (E-AI3) 77: G500ETH fault (E-E71) 78: G500XLT fault (E-E72) 79: Reserved		
P07.33	Running frequency of present fault		0.00Hz	●
P07.34	Ramps reference frequency of present fault		0.00Hz	●
P07.35	Output voltage of present fault		0V	●
P07.36	Output current of present fault		0.0A	●
P07.37	Bus voltage of present fault		0.0V	●
P07.38	Max. temperature of present fault		0.0°C	●
P07.39	Input terminal state of present fault		0	●
P07.40	Output terminal state of present fault		0	●
P07.41	Running frequency of the last fault		0.00Hz	●
P07.42	Ramps reference frequency of the last fault		0.00Hz	●
P07.43	Output voltage of the last fault		0V	●
P07.44	Output current of the last fault		0.0A	●
P07.45	Bus voltage of the last fault		0.0V	●
P07.46	Max. temperature of the last fault		0.0°C	●
P07.47	Input terminal state of the last fault		0	●
P07.48	Output terminal state of the last fault		0	●
P07.49	Running frequency of the second to last fault		0.00Hz	●
P07.50	Ramps reference frequency of the second to last fault		0.00Hz	●
P07.51	Output voltage of the second to last fault		0V	●
P07.52	Output current of the second to last fault		0.0A	●
P07.53	Bus voltage of the second to last fault		0.0V	●
P07.54	Max. temperature of the second to last fault		0.0°C	●
P07.55	Input terminal state of the second to last fault		0	●
P07.56	Output terminal state of the second to last fault		0	●

P08 group Enhanced functions

Function code	Name	Description	Default value	Modify
P08.00	Acceleration time 2	See P00.11 and P00.12 for detailed definitions. G500 series inverter defines four groups of acceleration/deceleration time, which can be selected by multi-function digital input terminal	Depend on model	○
P08.01	Deceleration time 2		Depend on model	○

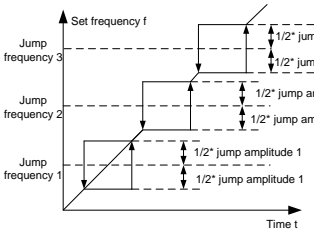
Function code	Name	Description	Default value	Modify
P08.02	Acceleration time 3	(P05 group). The acceleration/deceleration time of the inverter is the first group by default. Setting range: 0.0–3600.0s	Depend on model	<input type="radio"/>
P08.03	Deceleration time 3		Depend on model	<input type="radio"/>
P08.04	Acceleration time 4		Depend on model	<input type="radio"/>
P08.05	Deceleration time 4		Depend on model	<input type="radio"/>
P08.06	Running frequency of jogging	This function code is used to define the reference frequency of the inverter during jogging. Setting range: 0.00Hz–P00.03 (Max. output frequency)	5.00Hz	<input type="radio"/>
P08.07	Acceleration time of jogging	Jogging acceleration time is the time needed for the inverter to accelerate from 0Hz to Max. output frequency (P00.03).	Depend on model	<input type="radio"/>
P08.08	Deceleration time of jogging	Jogging deceleration time is the time needed from decelerating from Max. output frequency (P00.03) to 0Hz. Setting range: 0.0–3600.0s		<input type="radio"/>
P08.09	Jump frequency 1	When the set frequency is within the range of jump frequency, the inverter will run at the boundary of jump frequency. The inverter can avoid mechanical resonance point by setting the jump frequency, and three jump frequency points can be set. If the jump frequency points are set to 0, this function will be invalid.	0.00Hz	<input type="radio"/>
P08.10	Jump frequency amplitude 1		0.00Hz	<input type="radio"/>
P08.11	Jump frequency 2		0.00Hz	<input type="radio"/>
P08.12	Jump frequency amplitude 2		0.00Hz	<input type="radio"/>
P08.13	Jump frequency 3		0.00Hz	<input type="radio"/>
P08.14	Jump frequency amplitude 3		 <p>Setting range: 0.00Hz–P00.03 (Max. output frequency)</p>	0.00Hz
P08.15	Amplitude of wobbling	0.0–100.0% (relative to set frequency)	0.0%	<input type="radio"/>

Function code	Name	Description	Default value	Modify
	frequency			
P08.16	Amplitude of jump frequency	0.0–50.0% (relative to amplitude of wobbling frequency)	0.0%	<input type="radio"/>
P08.17	Rise time of wobbling frequency	0.1–3600.0s	5.0s	<input type="radio"/>
P08.18	Descend time of wobbling frequency	0.1–3600.0s	5.0s	<input type="radio"/>
P08.19	Switching frequency of acceleration/deceleration time	0.00–P00.03 (Max. output frequency) 0.00Hz: no switch-over Switch to acceleration/deceleration time 2 if the running frequency is larger than P08.19	0.00Hz	<input type="radio"/>
P08.20	Frequency threshold of the start of droop control	0.00–50.00Hz	2.00Hz	<input type="radio"/>
P08.21	Reference frequency of acceleration/deceleration time	0: Max. output frequency 1: Set frequency 2: 100Hz Note: Valid for straight acceleration/deceleration only.	0	<input checked="" type="radio"/>
P08.22	Output torque calculation mode	0: Calculated based on torque current	0	<input type="radio"/>
P08.23	Number of decimal points of frequency	0: Two decimal points 1: One decimal point	0	<input type="radio"/>
P08.24	Number of decimal points of linear speed	0: No decimal point 1: One 2: Two 3: Three	0	<input type="radio"/>
P08.25	Set count value	P08.26–65535	0	<input type="radio"/>
P08.26	Designated count value	0–P08.25	0	<input type="radio"/>
P08.27	Set running time	0–65535min	0min	<input type="radio"/>
P08.28	Automatic fault reset times	Automatic fault reset times: When the inverter selects automatic fault reset, it is used to set the	0	<input type="radio"/>
P08.29	Automatic fault	times of automatic reset, if the continuous reset	1.0s	<input type="radio"/>

Function code	Name	Description	Default value	Modify
	reset time interval	times exceeds the value set by P08.29, the inverter will report fault and stop to wait for repair. Interval of automatic fault reset: select the interval time from when fault occurred to automatic fault reset actions. After inverter starts, if no fault occurred during 60s, the fault reset times will be zeroed out. Setting range of P08.28: 0–10 Setting range of P08.29: 0.1–3600.0s		
P08.30	Reduction ratio of droop control	This function code sets the variation rate of the inverter output frequency based on the load; it is mainly used in balancing the power when multiple motors drive the same load. Setting range: 0.00–50.00Hz	0.00Hz	○
P08.31	Switch-over between motor 1 and motor 2	0x00–0x14 Ones: Switch-over channel 0: Switch over by terminal 1: Switch over by Modbus/Modbus TCP communication 2: Switch over by PROFIBUS/CANopen/DeviceNet/ G500XLT 3: Switch over by Ethernet communication 4: Switch over by EtherCAT/PROFINET/EthernetIP/ G500ETH communication Tens: Motor switch over during running 0: Disable switch over during running 1: Enable switch over during running	0x00	◎
P08.32	FDT1 level detection value	When the output frequency exceeds the corresponding frequency of FDT level, multi-function digital output terminal outputs "frequency level detection FDT" signal, this signal will be valid until the output frequency decreases below the corresponding frequency (FDT level-FDT lag detection value). The waveform is shown in the figure below.	60.00Hz	○
P08.33	FDT1 lag detection value		5.0%	○
P08.34	FDT2 level detection value		60.00Hz	○
P08.35	FDT2 lag detection value		5.0%	○

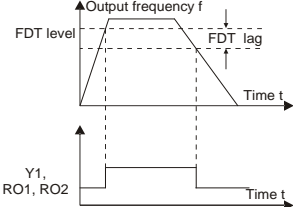
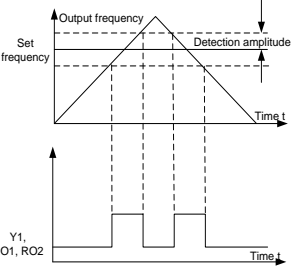
Function code	Name	Description	Default value	Modify
		 <p>Setting range of P08.32: 0.00Hz~P00.03 (Max. output frequency) Setting range of P08.33: 0.0~100.0% (FDT1 level) Setting range of P08.34: 0.00Hz~P00.03 (Max. output frequency) Setting range of P08.35: 0.0~100.0% (FDT2 level)</p>		
P08.36	Detection value for frequency arrival	<p>When the output frequency is within the positive /negative detection range of the set frequency, the multi-function digital output terminal outputs "frequency arrival" signal as shown below.</p>  <p>Setting range: 0.00Hz~P00.03 (Max. output frequency)</p>	0.00Hz	○
P08.37	Enable/disable energy-consumption brake	<p>0: Disable energy-consumption brake 1: Enable energy-consumption brake</p>	1	○
P08.38	Energy-consumption brake threshold voltage	<p>Set the starting bus voltage of energy-consumption brake. Adjusting this value properly can brake the load effectively. The default value will change with the change of voltage class. Setting range: 200.0~2000.0V</p>	220V voltage: 380.0V; 460V voltage: 740.0V;	○

Function code	Name	Description	Default value	Modify
			575V voltage: 1000.0V	
P08.39	Running mode of cooling fan	0: Common running mode 1: The fan keeps running after power up 2: Run mode 2	0	○
P08.40	PWM selection	0x0000–0x1121 Ones: PWM mode 0: 3PH modulation and 2-phase modulation 1: 3PH modulation Tens: PWM low-speed carrier limit 0: Limit low-speed carrier to 2K 1: Limit low-speed carrier to 4K 2: No limit on low-speed carrier Hundreds: Deadzone compensation mode 0: Compensation mode 1 1: Compensation mode 2 Thousands: PWM loading mode 0: PWM loading mode 1 1: PWM loading mode 2	0x1101	◎
P08.41	Overmodulation selection	0x0000–0x1111 Ones 0: Overmodulation is invalid 1: Overmodulation is valid Tens 0: Mild overmodulation 1: Significant overmodulation Hundreds: Carrier frequency limit 0: Yes 1: No Thousands: Output voltage compensation 0: No 1: Yes	0x1001	◎
P08.42	Reserved			
P08.43	Reserved			
P08.44	UP/DOWN terminal control setting	0x000–0x221 Ones: Frequency control selection 0: UP/DOWN terminal setting is valid	0x000	○

Function code	Name	Description	Default value	Modify
		1: UP/DOWN terminal setting is invalid Tens: Frequency control selection 0: Valid only when P00.06=0 or P00.07=0 1: All frequency modes are valid 2: Invalid for multi-step speed when multi-step speed takes priority Hundreds: Action selection during stop 0: Valid 1: Valid during running, clear after stop 2: Valid during running, clear after receiving stop command		
P08.45	UP terminal frequency incremental integral rate	0.01–50.00Hz/s	0.50Hz/s	<input type="radio"/>
P08.46	DOWN terminal frequency decremental change rate	0.01–50.00Hz/s	0.50Hz/s	<input type="radio"/>
P08.47	Action selection for frequency setting during power down	0x000–0x111 Ones: Action selection for frequency setting (by keypad digits) during power down 0: Save during power down 1: Zero out during power down Tens: Action selection for frequency setting (by Modbus/Modbus TCP) during power down 0: Save during power down 1: Zero out during power down Hundreds: Action selection for frequency setting (by other communication) during power down 0: Save during power down 1: Zero out during power down	0x000	<input type="radio"/>
P08.48	High bit of initial value of power consumption	Set the initial value of power consumption. Initial value of power consumption=P08.48×1000+ P08.49	0 kWh	<input type="radio"/>
P08.49	Low bit of initial value of power consumption	Setting range of P08.48: 0–59999 kWh (k) Setting range of P08.49: 0.0–999.9 kWh	0.0 kWh	<input type="radio"/>

Function code	Name	Description	Default value	Modify
P08.50	Flux braking	<p>This function code is used to enable flux braking function.</p> <p>0: Invalid 100–150: The larger the coefficient, the stronger the brake intensity</p> <p>The inverter enables motor to decelerate quickly by increasing the motor flux which converts energy generated during braking into thermal energy.</p> <p>The inverter monitors motor state continuously even during flux braking, thus flux braking can be applied in motor stop or used to change motor speed. Flux braking also has the following advantages.</p> <p>1) Brake immediately after sending stop command, removing the need to wait for flux to attenuate.</p> <p>2) Better cooling effect. During flux braking, the stator current of the motor increases, while the rotor current does not change, while the cooling effect of the stator is much more effective than that of the rotor.</p>	0	<input type="radio"/>
P08.51	Inverter input power factor	<p>This function code is used to adjust the current display value on the AC input side.</p> <p>Setting range: 0.00–1.00</p>	0.56	<input type="radio"/>
P08.52	STO lock	<p>0: STO alarm lock Alarm-lock means STO alarm must be reset after state restoration when STO occurs.</p> <p>1: STO alarm unlock Alarm-unlock means when STO occurs, after state restoration, STO alarm will disappear automatically.</p>	0	<input type="radio"/>
P08.53	Bias value of upper limit frequency of torque control	<p>0.00 Hz–P00.03 (Max. output frequency)</p> <p>Note: This parameter is valid only for the torque control mode.</p>	0.00Hz	<input type="radio"/>
P08.54	Acceleration/deceleration selection of upper limit frequency of torque control	<p>0: No limit on acceleration or deceleration</p> <p>1: Acceleration/deceleration time 1 2: Acceleration/deceleration time 2 3: Acceleration/deceleration time 3 4: Acceleration/deceleration time 4</p>	0	<input type="radio"/>

Function code	Name	Description	Default value	Modify
P08.55	Enabling auto carrier frequency reduction	0: Disable 1: Enable Note: Automatic carrier frequency reduction indicates that the inverter automatically reduces the carrier frequency when detecting the heat sink temperature exceeds the rated temperature. When the temperature decreases to a certain degree, the carrier frequency recovers. This function reduces the chance of inverter overheat alarm.	0	<input type="radio"/>
P08.56	Min. carrier frequency	0.0–15.0kHz	Depends on model	<input checked="" type="radio"/>
P08.57	Temperature point of auto carrier frequency reduction	40.0–85.0°C	70.0°C	<input type="radio"/>
P08.58	Interval of carrier frequency reduction	0–30min	10min	<input type="radio"/>
P08.59	A11 disconnection detection threshold	0–100%	0	<input type="radio"/>
P08.60	A12 disconnection detection threshold	0–100%	0	<input type="radio"/>
P08.61	A13 disconnection detection threshold	0–100%	0	<input type="radio"/>
P08.62	Output current filter time	0.000–10.000s	0.000	<input type="radio"/>
P08.63	Output torque filter times	0–8	8	<input type="radio"/>

P09 group PID control

Function code	Name	Description	Default value	Modify
P09.00	PID reference source	When frequency command (P00.06, P00.07) is set to 7, or channel of voltage setting (P04.27) is set to 6, the inverter running mode is process PID control. This parameter determines the target reference channel of process PID.	0	<input type="radio"/>

Function code	Name	Description	Default value	Modify
		0: Keypad (P09.01) 1: AI1 2: AI2 3: AI3 4: High-speed pulse HDIA 5: Multi-step 6: Modbus/Modbus TCP communication 7: PROFIBUS/CANopen/DeviceNet/ G500XLT communication 8: Ethernet communication 9: High-speed pulse HDIB 10: EtherCAT/PROFINET/EtherNet IP/ G500ETH communication 11: Programmable expansion card 12: Reserved The set target value of process PID is relative value, the set 100% corresponds to 100% of the feedback signal of controlled system. The system operates based on the relative value (0–100.0%)		
P09.01	Pre-set PID reference of keypad	Users need to set this parameter when P09.00 is set to 0, the reference value of this parameter is the feedback variable of the system. Setting range: -100.0%–100.0%	0.0%	○
P09.02	PID feedback source	This parameter is used to select PID feedback channel. 0: AI1 1: AI2 2: AI3 3: High-speed pulse HDIA 4: Modbus/Modbus TCP communication 5: PROFIBUS/CANopen/DeviceNet/ G500XLT communication 6: Ethernet communication 7: High-speed pulse HDIB 8: EtherCAT/PROFINET/EtherNet IP/ G500ETH communication 9: Programmable expansion card	0	○

Function code	Name	Description	Default value	Modify
		10: Reserved Note: The reference channel and feedback channel cannot overlap; otherwise, PID cannot be controlled effectively.		
P09.03	PID output characteristics	0: PID output is a positive characteristic: namely, the feedback signal is larger than the PID reference, which requires the inverter output frequency to decrease for PID to reach balance, eg, tension PID control of winding 1: PID output is a negative characteristic: namely the feedback signal is less than PID reference, which requires inverter output frequency to increase for PID to reach balance, eg, tension PID control of unwinding.	0	<input type="radio"/>
P09.04	Proportional gain (Kp)	This function code is suitable for proportional gain P of PID input. It determines the regulation intensity of the entire PID regulator, the larger the value of P, the stronger the regulation intensity. If this parameter is 100, it means when the deviation between PID feedback and reference is 100%, the regulation amplitude of the PID regulator (ignoring integral and differential effect) on output frequency command is the max. frequency (ignoring integral and differential actions). Setting range: 0.00–100.00	1.80	<input type="radio"/>
P09.05	Integral time (Ti)	It determines the speed of integral regulation made on the deviation between PID feedback and reference by the PID regulator. When the deviation between the PID feedback and reference is 100%, the regulation of integral regulator (ignoring integral and differential actions), after undergoing continuous regulation during this time period, can reach Max. output frequency (P00.03) The shorter the integral time, the stronger the regulation intensity. Setting range: 0.00–10.00s	0.90s	<input type="radio"/>

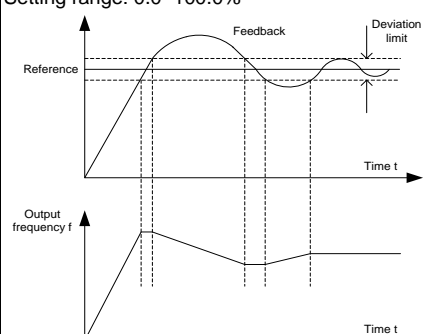
Function code	Name	Description	Default value	Modify
P09.06	Derivative time (Td)	It determines the intensity of the regulation made on the change rate of deviation between PID feedback and reference by the PID regulator. If feedback changes by 100% during this period, the regulation of the differential regulator (ignoring integral and differential actions) is Max. output frequency (P00.03) The longer the derivative time, the stronger the regulation intensity. Setting range: 0.00–10.00s	0.00s	<input type="radio"/>
P09.07	Sampling cycle (T)	It means the sampling cycle of feedback. The regulator operates once during each sampling cycle. The larger the sampling cycle, the slower the response. Setting range: 0.001–10.000s	0.001s	<input type="radio"/>
P09.08	Limit of PID control deviation	It is the max. allowable deviation of PID system output value relative to closed-loop reference value. Within this limit, PID regulator stops regulation. Set this function code properly to regulate the precision and stability of PID system. Setting range: 0.0–100.0% 	0.0%	<input type="radio"/>
P09.09	Upper limit value of PID output	These two function codes are used to set the upper/lower limit value of PID regulator. 100.0% corresponds to Max. output frequency (P00.03) or max. voltage (P04.31) Setting range of P09.09: P09.10–100.0% Setting range of P09.10: -100.0%–P09.09	100.0%	<input type="radio"/>
P09.10	Lower limit value of PID output		0.0%	<input type="radio"/>

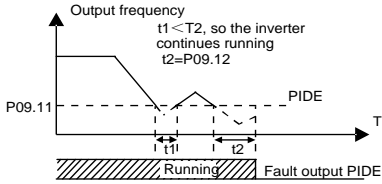
Function code	Name	Description	Default value	Modify
P09.11	Feedback offline detection value	Set PID feedback offline detection value, when the detection value is no more than the feedback offline detection value, and the duration exceeds the value set in P09.12, the inverter will report "PID feedback offline fault", and keypad displays PIDE.	0.0%	<input type="radio"/>
P09.12	Feedback offline detection time	 <p>Setting range of P09.11: 0.0–100.0% Setting range of P09.12: 0.0–3600.0s</p>	1.0s	<input type="radio"/>
P09.13	PID control selection	<p>0x0000–0x1111</p> <p>Ones:</p> <p>0: Continue integral control after the frequency reaches upper/lower limit 1: Stop integral control after the frequency reaches upper/lower limit</p> <p>Tens:</p> <p>0: The same with the main reference direction 1: Contrary to the main reference direction</p> <p>Hundreds:</p> <p>0: Limit based on the max. frequency 1: Limit based on A frequency</p> <p>Thousands:</p> <p>0: A+B frequency, acceleration /deceleration of main reference A frequency source buffering is invalid 1: A+B frequency, acceleration/ deceleration of main reference A frequency source buffering is valid, acceleration and deceleration are determined by P08.04 (acceleration time 4).</p>	0x0001	<input type="radio"/>
P09.14	Low-frequency proportional gain (Kp)	0.00–100.00 Low-frequency switching point: 5.00Hz, high-frequency switching point: 10.00Hz (P09.04 corresponds to high-frequency parameter), and the middle is the linear interpolation between these two points	1.00	<input type="radio"/>

Function code	Name	Description	Default value	Modify
P09.15	Acceleration/ deceleration time of PID command	0.0–1000.0s	0.0s	<input type="radio"/>
P09.16	Filter time of PID output	0.000–10.000s	0.000s	<input type="radio"/>
P09.17	Reserved			
P09.18	Low-frequency integral time	Refer to P09.05. Setting range: 0.00–10.00s	0.90s	<input type="radio"/>
P09.19	Low-frequency differential time	Refer to P09.06. Setting range: 0.00–10.00s	0.00s	<input type="radio"/>
P09.20	Lower frequency point for PID parameter switching		5.00 Hz	<input type="radio"/>
P09.21	Upper frequency point for PID parameter switching		10.00 Hz	<input type="radio"/>
P09.22– P09.28	Reserved			

P10 group Simple PLC and multi-step speed control

Function code	Name	Description	Default value	Modify
P10.00	Simple PLC mode	0: Stop after running once; the inverter stops automatically after running for one cycle, and it can be started only after receiving running command. 1: Keep running in the final value after running once; The inverter keeps the running frequency and direction of the last section after a single cycle. 2: Cyclic running; the inverter enters the next cycle after completing one cycle until receiving stop command and stops.	0	<input type="radio"/>
P10.01	Simple PLC memory selection	0: No memory after power down 1: Memory after power down; PLC memories its running stage and running frequency before power down.	0	<input type="radio"/>

Function code	Name	Description	Default value	Modify
P10.02	Multi-step speed 0	<p>Setting range of the frequency in 0th–15th sections are -100.0–100.0%, 100% corresponds to Max. output frequency P00.03.</p> <p>Setting range of the running time in 0th–15th sections are 0.0–6553.5s (min), the time unit is determined by P10.37.</p> <p>When simple PLC operation is selected, it is required to set P10.02–P10.33 to determine the running frequency and running time of each section.</p> <p>Note: The symbol of multi-step speed determines the running direction of simple PLC, and the negative value means reverse running.</p>	0.0%	○
P10.03	Running time of step 0		0.0s(min)	○
P10.04	Multi-step speed 1		0.0%	○
P10.05	Running time of step 1		0.0s(min)	○
P10.06	Multi-step speed 2		0.0%	○
P10.07	Running time of step 2		0.0s(min)	○
P10.08	Multi-step speed 3		0.0%	○
P10.09	Running time of step 3		0.0s(min)	○
P10.10	Multi-step speed 4		0.0%	○
P10.11	Running time of step 4		0.0s(min)	○
P10.12	Multi-step speed 5		0.0%	○
P10.13	Running time of step 5		0.0s(min)	○
P10.14	Multi-step speed 6		0.0%	○
P10.15	Running time of step 6		0.0s(min)	○
P10.16	Multi-step speed 7		0.0%	○
P10.17	Running time of step 7		0.0s(min)	○
P10.18	Multi-step speed 8		0.0%	○
P10.19	Running time of step 8		0.0s(min)	○
P10.20	Multi-step speed 9		0.0%	○
P10.21	Running time of step 9		0.0s(min)	○
P10.22	Multi-step speed 10		0.0%	○
P10.23	Running time of step 10		0.0s(min)	○
P10.24	Multi-step speed 11		0.0%	○

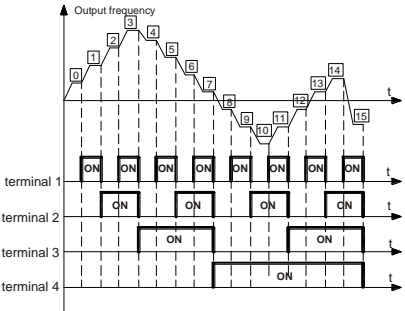
Function code	Name	Description	Default value	Modify																																																																																										
P10.25	Running time of step 11	 <p>When terminal 1, terminal 2, terminal 3 and terminal 4 are OFF, the frequency input mode is set by P00.06 or P00.07. When terminal 1, terminal 2, terminal 3 and terminal 4 are not all OFF, the frequency set by multi-step speed will prevail, and the priority of multi-step setting is higher than that of the keypad, analog, high-speed pulse, PID, and communication settings.</p> <p>The relation between terminal 1, terminal 2, terminal 3 and terminal 4 are shown in the table below.</p> <table border="1" data-bbox="408 885 812 1197"> <tr><td>Terminal 1</td><td>OFF</td><td>ON</td><td>OFF</td><td>ON</td><td>OFF</td><td>ON</td><td>OFF</td><td>ON</td></tr> <tr><td>Terminal 2</td><td>OFF</td><td>OFF</td><td>ON</td><td>ON</td><td>OFF</td><td>OFF</td><td>ON</td><td>ON</td></tr> <tr><td>Terminal 3</td><td>OFF</td><td>OFF</td><td>OFF</td><td>OFF</td><td>ON</td><td>ON</td><td>ON</td><td>ON</td></tr> <tr><td>Terminal 4</td><td>OFF</td><td>OFF</td><td>OFF</td><td>OFF</td><td>OFF</td><td>OFF</td><td>OFF</td><td>OFF</td></tr> <tr><td>Step</td><td>0</td><td>1</td><td>2</td><td>3</td><td>4</td><td>5</td><td>6</td><td>7</td></tr> <tr><td>Terminal 1</td><td>OFF</td><td>ON</td><td>OFF</td><td>ON</td><td>OFF</td><td>ON</td><td>OFF</td><td>ON</td></tr> <tr><td>Terminal 2</td><td>OFF</td><td>OFF</td><td>ON</td><td>ON</td><td>OFF</td><td>OFF</td><td>ON</td><td>ON</td></tr> <tr><td>Terminal 3</td><td>OFF</td><td>OFF</td><td>OFF</td><td>OFF</td><td>ON</td><td>ON</td><td>ON</td><td>ON</td></tr> <tr><td>Terminal 4</td><td>ON</td><td>ON</td><td>ON</td><td>ON</td><td>ON</td><td>ON</td><td>ON</td><td>ON</td></tr> <tr><td>Step</td><td>8</td><td>9</td><td>10</td><td>11</td><td>12</td><td>13</td><td>14</td><td>15</td></tr> </table>	Terminal 1	OFF	ON	OFF	ON	OFF	ON	OFF	ON	Terminal 2	OFF	OFF	ON	ON	OFF	OFF	ON	ON	Terminal 3	OFF	OFF	OFF	OFF	ON	ON	ON	ON	Terminal 4	OFF	OFF	OFF	OFF	OFF	OFF	OFF	OFF	Step	0	1	2	3	4	5	6	7	Terminal 1	OFF	ON	OFF	ON	OFF	ON	OFF	ON	Terminal 2	OFF	OFF	ON	ON	OFF	OFF	ON	ON	Terminal 3	OFF	OFF	OFF	OFF	ON	ON	ON	ON	Terminal 4	ON	ON	ON	ON	ON	ON	ON	ON	Step	8	9	10	11	12	13	14	15	0.0s(min)	<input type="radio"/>
Terminal 1	OFF		ON	OFF	ON	OFF	ON	OFF	ON																																																																																					
Terminal 2	OFF		OFF	ON	ON	OFF	OFF	ON	ON																																																																																					
Terminal 3	OFF		OFF	OFF	OFF	ON	ON	ON	ON																																																																																					
Terminal 4	OFF		OFF	OFF	OFF	OFF	OFF	OFF	OFF																																																																																					
Step	0		1	2	3	4	5	6	7																																																																																					
Terminal 1	OFF		ON	OFF	ON	OFF	ON	OFF	ON																																																																																					
Terminal 2	OFF		OFF	ON	ON	OFF	OFF	ON	ON																																																																																					
Terminal 3	OFF		OFF	OFF	OFF	ON	ON	ON	ON																																																																																					
Terminal 4	ON		ON	ON	ON	ON	ON	ON	ON																																																																																					
Step	8		9	10	11	12	13	14	15																																																																																					
P10.26	Multi-step speed 12		0.0%	<input type="radio"/>																																																																																										
P10.27	Running time of step 12		0.0s(min)	<input type="radio"/>																																																																																										
P10.28	Multi-step speed 13		0.0%	<input type="radio"/>																																																																																										
P10.29	Running time of step 13		0.0s(min)	<input type="radio"/>																																																																																										
P10.30	Multi-step speed 14	0.0%	<input type="radio"/>																																																																																											
P10.31	Running time of step 14	0.0s(min)	<input type="radio"/>																																																																																											
P10.32	Multi-step speed 15	0.0%	<input type="radio"/>																																																																																											
P10.33	Running time of step 15	0.0s(min)	<input type="radio"/>																																																																																											
P10.34	Acceleration/deceleration time of steps 0–7 of simple PLC	Detailed illustration is shown in the table below.	0x0000	<input type="radio"/>																																																																																										
P10.35	Acceleration/deceleration time of steps 8–15 of simple PLC	<table border="1" data-bbox="408 1236 812 1452"> <thead> <tr> <th>Func code</th> <th colspan="2">Binary</th> <th>Step No.</th> <th>ACC/ time 1</th> <th>ACC/ time 2</th> <th>ACC/ time 3</th> <th>ACC/ time 4</th> </tr> </thead> <tbody> <tr> <td rowspan="3">P10.34</td> <td>BIT1</td> <td>BIT0</td> <td>0</td> <td>00</td> <td>01</td> <td>10</td> <td>11</td> </tr> <tr> <td>BIT3</td> <td>BIT2</td> <td>1</td> <td>00</td> <td>01</td> <td>10</td> <td>11</td> </tr> <tr> <td>BIT5</td> <td>BIT4</td> <td>2</td> <td>00</td> <td>01</td> <td>10</td> <td>11</td> </tr> </tbody> </table>	Func code	Binary		Step No.	ACC/ time 1	ACC/ time 2	ACC/ time 3	ACC/ time 4	P10.34	BIT1	BIT0	0	00	01	10	11	BIT3	BIT2	1	00	01	10	11	BIT5	BIT4	2	00	01	10	11	0x0000	<input type="radio"/>																																																												
Func code	Binary		Step No.	ACC/ time 1	ACC/ time 2	ACC/ time 3	ACC/ time 4																																																																																							
P10.34	BIT1	BIT0	0	00	01	10	11																																																																																							
	BIT3	BIT2	1	00	01	10	11																																																																																							
	BIT5	BIT4	2	00	01	10	11																																																																																							

Function code	Name	Description	Default value	Modify																																																																																																		
		<table border="1" data-bbox="404 213 815 611"> <tr><td>BIT7</td><td>BIT6</td><td>3</td><td>00</td><td>01</td><td>10</td><td>11</td></tr> <tr><td>BIT9</td><td>BIT8</td><td>4</td><td>00</td><td>01</td><td>10</td><td>11</td></tr> <tr><td>BIT11</td><td>BIT10</td><td>5</td><td>00</td><td>01</td><td>10</td><td>11</td></tr> <tr><td>BIT13</td><td>BIT12</td><td>6</td><td>00</td><td>01</td><td>10</td><td>11</td></tr> <tr><td>BIT15</td><td>BIT14</td><td>7</td><td>00</td><td>01</td><td>10</td><td>11</td></tr> <tr><td colspan="7" style="text-align:center">P10.35</td></tr> <tr><td>BIT1</td><td>BIT0</td><td>8</td><td>00</td><td>01</td><td>10</td><td>11</td></tr> <tr><td>BIT3</td><td>BIT2</td><td>9</td><td>00</td><td>01</td><td>10</td><td>11</td></tr> <tr><td>BIT5</td><td>BIT4</td><td>10</td><td>00</td><td>01</td><td>10</td><td>11</td></tr> <tr><td>BIT7</td><td>BIT6</td><td>11</td><td>00</td><td>01</td><td>10</td><td>11</td></tr> <tr><td>BIT9</td><td>BIT8</td><td>12</td><td>00</td><td>01</td><td>10</td><td>11</td></tr> <tr><td>BIT11</td><td>BIT10</td><td>13</td><td>00</td><td>01</td><td>10</td><td>11</td></tr> <tr><td>BIT13</td><td>BIT12</td><td>14</td><td>00</td><td>01</td><td>10</td><td>11</td></tr> <tr><td>BIT15</td><td>BIT14</td><td>15</td><td>00</td><td>01</td><td>10</td><td>11</td></tr> </table> <p data-bbox="393 632 826 946"> Select corresponding acceleration/deceleration time, and then convert 16-bit binary number into hexadecimal number, finally, set corresponding function code. Acceleration/deceleration time 1 is set by P00.11 and P00.12; Acceleration/deceleration time 2 is set by P08.00 and P08.01; Acceleration/deceleration time 3 is set by P08.02 and P08.03; Acceleration /deceleration time 4 is set by P08.04 and P08.05. Setting range: 0x0000–0xFFFF </p>	BIT7	BIT6	3	00	01	10	11	BIT9	BIT8	4	00	01	10	11	BIT11	BIT10	5	00	01	10	11	BIT13	BIT12	6	00	01	10	11	BIT15	BIT14	7	00	01	10	11	P10.35							BIT1	BIT0	8	00	01	10	11	BIT3	BIT2	9	00	01	10	11	BIT5	BIT4	10	00	01	10	11	BIT7	BIT6	11	00	01	10	11	BIT9	BIT8	12	00	01	10	11	BIT11	BIT10	13	00	01	10	11	BIT13	BIT12	14	00	01	10	11	BIT15	BIT14	15	00	01	10	11		
BIT7	BIT6	3	00	01	10	11																																																																																																
BIT9	BIT8	4	00	01	10	11																																																																																																
BIT11	BIT10	5	00	01	10	11																																																																																																
BIT13	BIT12	6	00	01	10	11																																																																																																
BIT15	BIT14	7	00	01	10	11																																																																																																
P10.35																																																																																																						
BIT1	BIT0	8	00	01	10	11																																																																																																
BIT3	BIT2	9	00	01	10	11																																																																																																
BIT5	BIT4	10	00	01	10	11																																																																																																
BIT7	BIT6	11	00	01	10	11																																																																																																
BIT9	BIT8	12	00	01	10	11																																																																																																
BIT11	BIT10	13	00	01	10	11																																																																																																
BIT13	BIT12	14	00	01	10	11																																																																																																
BIT15	BIT14	15	00	01	10	11																																																																																																
P10.36	PLC restart mode	<p data-bbox="393 951 826 1066">0: Restart from the multi-step speed 0, namely if the inverter stops during running (caused by stop command, fault or power down), it will run from the first step after restart.</p> <p data-bbox="393 1070 826 1302">1: Continue running from the step frequency when interruption occurred, namely if the inverter stops during running (caused by stop command or fault), it will record the running time of current step, and enters this step automatically after restart, then continue running at the frequency defined by this step in the remaining time.</p>	0	☉																																																																																																		
P10.37	Multi-step time unit	<p data-bbox="393 1307 826 1358">0: s; the running time of each step is counted in seconds;</p> <p data-bbox="393 1362 826 1420">1: min; the running time of each step is counted in minutes;</p>	0	☉																																																																																																		

P11 group Protection parameters

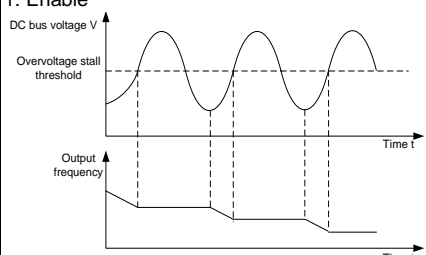
Function code	Name	Description	Default value	Modify
P11.00	Phase-loss protection	0x000–0x111 Ones: 0: Disable software input phase loss protection 1: Enable software input phase loss protection Tens: 0: Disable output phase loss protection 1: Enable output phase loss protection Hundreds: 0: Disable hardware input phase loss protection 1: Enable hardware input phase loss protection	0x110	<input type="radio"/>
P11.01	Frequency-drop at transient power down	0: Disable 1: Enable	0	<input type="radio"/>
P11.02	Enabling dynamic braking for stop	0: Enable 1: Disable	0	<input checked="" type="radio"/>
P11.03	Overvoltage stall protection	0: Disable 1: Enable 	1	<input type="radio"/>
P11.04	Overvoltage stall protection voltage	120–150% (standard bus voltage) (220V)	120%	<input type="radio"/>
		120–150% (standard bus voltage) (460V)	120%	
		120–150% (standard bus voltage) (575V)	120%	
P11.05	Current-limit selection	During accelerated running, as the load is too large, the actual acceleration rate of motor is lower than that of output frequency, if no measures are taken, the inverter may trip due to overcurrent during acceleration. 0x00–0x11 Ones: Current-limit action selection 0: Invalid 1: Always valid Tens: Hardware current-limit overload alarm selection	0x01	<input checked="" type="radio"/>

Function code	Name	Description	Default value	Modify
		0: Valid 1: Invalid		
P11.06	Automatic current-limit level	Current-limit protection function detects output current during running, and compares it with the current-limit level defined by P11.06, if it exceeds the current-limit level, the inverter will run at stable frequency during accelerated running, or run in decreased frequency during constant-speed running; if it exceeds the current-limit level continuously, the inverter output frequency will drop continuously until reaching lower limit frequency. When the output current is detected to be lower than the current-limit level again, it will continue accelerated running.	G model: 160.0% P model: 120.0%	⊙
P11.07	Frequency-drop rate during current limit	<p>Setting range of P11.06: 50.0–200.0% Setting range of P11.07: 0.00–50.00Hz/s</p>	10.00 Hz/s	⊙
P11.08	Inverter or motor overload/ underload pre-alarm	If the inverter or motor output current is larger than the overload pre-alarm detection level (P11.09), and the duration exceeds the overload pre-alarm detection time (P11.10), overload pre-alarm signal will be outputted.	0x0000	○
P11.09	Overload pre-alarm detection level		G model: 150% P model: 120%	○
P11.10	Overload pre-alarm detection time		1.0s	○

Function code	Name	Description	Default value	Modify
		Setting range of P11.08: Enable and define overload pre-alarm function of the inverter and motor Setting range: 0x0000–0x1134 Ones: 0: Motor overload/underload pre-alarm, relative to rated motor current; 1: Inverter overload/underload pre-alarm, relative to rated inverter current. 2: Inverter output torque overload/underload pre-alarm, relative to rated motor torque 3: Motor overload/underload pre-alarm. The overload is relative to the motor rated current; while the underload is relative to the motor rated power. 4: Inverter overload/underload pre-alarm. The overload is relative to the inverter rated current; while the underload is relative to the inverter rated power. Tens: 0: The inverter continues running after overload/underload alarm; 1: The inverter continues running after underload alarm, and stops running after overload fault; 2: The inverter continues running after overload alarm, and stops running after underload fault; 3: The inverter stops running after overload/underload fault. Hundreds: 0: Always detect 1: Detect during constant-speed running Setting range of P11.09: P11.11–200% Setting range of P11.10: 0.1–3600.0s		
P11.11	Underload pre-alarm detection level	Underload pre-alarm signal will be outputted if the output current of the inverter or motor is lower than underload pre-alarm detection level	50%	○

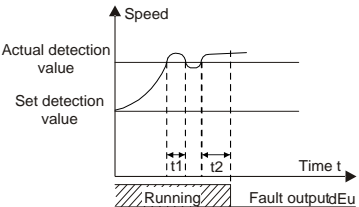
Function code	Name	Description	Default value	Modify
P11.12	Underload pre-alarm detection time	(P11.11), and the duration exceeds underload pre-alarm detection time (P11.12). Setting range of P11.11: 0– P11.09 Setting range of P11.12: 0.1–3600.0s	1.0s	<input type="radio"/>
P11.13	Fault output terminal action during fault	This function code is used to set the action of fault output terminals during undervoltage and fault reset. 0x00–0x11 Ones: 0: Act during undervoltage fault 1: Do not act during undervoltage fault Tens: 0: Act during fault reset 1: Do not act during fault reset	0x00	<input type="radio"/>
P11.14	Speed deviation detection value	0.0–50.0% This parameter is used to set the speed deviation detection value.	10.0%	<input type="radio"/>
P11.15	Speed deviation detection time	This parameter is used to set the speed deviation detection time. Note: Speed deviation protection will be invalid if P11.15 is set to 0.0.  Setting range: 0.0–10.0s	2.0s	<input type="radio"/>
P11.16	Automatic frequency-reduction during voltage drop	0–1 0: Invalid 1: Valid	0	<input type="radio"/>
P11.17	Proportional coefficient of voltage regulator	This parameter is used to set the proportional coefficient of the bus voltage regulator during undervoltage stall.	100	<input type="radio"/>

Function code	Name	Description	Default value	Modify
	during undervoltage stall	Setting range: 0–1000		
P11.18	Integral coefficient of voltage regulator during undervoltage stall	This parameter is used to set the integral coefficient of the bus voltage regulator during undervoltage stall. Setting range: 0–1000	40	<input type="radio"/>
P11.19	Proportional coefficient of current regulator during undervoltage stall	This parameter is used to set the proportional coefficient of the active current regulator during undervoltage stall. Setting range: 0–1000	25	<input type="radio"/>
P11.20	Integral coefficient of current regulator during undervoltage stall	This parameter is used to set the integral coefficient of the active current regulator during undervoltage stall. Setting range: 0–2000	150	<input type="radio"/>
P11.21	Proportional coefficient of voltage regulator during overvoltage stall	This parameter is used to set the proportional coefficient of the bus voltage regulator during overvoltage stall. Setting range: 0–1000	60	<input type="radio"/>
P11.22	Integral coefficient of voltage regulator during overvoltage stall	This parameter is used to set the integral coefficient of the bus voltage regulator during overvoltage stall. Setting range: 0–1000	10	<input type="radio"/>
P11.23	Proportional coefficient of current regulator during overvoltage stall	This parameter is used to set the proportional coefficient of the active current regulator during overvoltage stall. Setting range: 0–1000	60	<input type="radio"/>
P11.24	Integral coefficient of current regulator during overvoltage stall	This parameter is used to set the integral coefficient of the active current regulator during overvoltage stall. Setting range: 0–2000	250	<input type="radio"/>
P11.25	Enable inverter overload integral	0: Disabled 1: Enabled When this parameter is set to 0, the overload timing value is reset to zero after the inverter is stopped. In this case, the determination of inverter overload takes more time, and therefore	0	

Function code	Name	Description	Default value	Modify
		the effective protection over the inverter is weakened. When this parameter is set to 1, the overload timing value is not reset, and the overload timing value is accumulative. In this case, the determination of inverter overload takes less time, and therefore the protection over the inverter can be performed more quickly.		
P11.26	Reserved			
P11.27	VF vibration control method	0x00–0x11 Ones place: 0: Method 1 1: Method 2 Tens place: 0: Reserved 1: Reserved	0x00	⊙
P11.28	SPO switch-on detection delay time	0.0–60.0(s) Note: The SPO detection is started only after the inverter runs for the delay time P11.28 to avoid false alarms caused by the unstable frequency.	5.0s	○
P11.29	SPO unbalance factor	0–10	6	○
P11.30	Reserved			
P11.31	Fault severity group 1	0x0000–0x3333 Thousands place/Hundreds place/Tens	0x0000	○
P11.32	Fault severity group 2	place/Ones place: 0: Report the fault	0x0000	○
P11.33	Fault severity group 3	1: Report the fault after deceleration to stop 2: Pre-alarm, with the action executed according to P11.51	0x0000	○
P11.34	Fault severity group 4	3: Screen out the fault	0x0000	○
P11.35	Fault severity group 5	Note: Different fault actions are taken for different fault severities. The first 10 faults are not grouped by severity, but each four of the subsequent faults are grouped by severity in ascending order from right to left in hexadecimal	0x0000	○
P11.36	Fault severity group 6	format, that is, from the ones place to the thousands place (for example, the ones place of	0x0000	○
P11.37	Fault severity group 7	fault severity group 1 corresponds to fault 11).	0x0000	○
P11.38	Fault severity group 8	Group 1: Faults 11–14 (OL1, OL2, SPI, SPO)	0x0000	○

Function code	Name	Description	Default value	Modify
P11.39	Fault severity group 9	Group 2: Faults 15–18 (OH1, OH2, EF, CE) Group 3: Faults 19–22 (ItE, tE, EEP, PIDE)	0x0000	<input type="radio"/>
P11.40	Fault severity group 10	Group 4: Faults 23–26 (bCE, END, OL3, PCE) Group 5: Faults 27–30 (UPE, DNE, E-DP, E-NET)	0x0000	<input type="radio"/>
P11.41	Fault severity group 11	Group 6: Faults 31–34 (E-CAN, ETH1, ETH2, dEu)	0x0000	<input type="radio"/>
P11.42	Fault severity group 12	Group 7: Faults 35–38 (STo, LL, ENC1o, ENC1d)	0x0000	<input type="radio"/>
P11.43	Fault severity group 13	Group 8: Faults 39–42 (ENC1Z, STO, STL1, STL2)	0x0000	<input type="radio"/>
P11.44	Fault severity group 14	Group 9: Faults 43–46 (STL3, CrCE, P-E1, P-E2)	0x0000	<input type="radio"/>
P11.45	Fault severity group 15	Group 10: Faults 47–50 (P-E3, P-E4, P-E5, P-E6)	0x0000	<input type="radio"/>
P11.46	Fault severity group 16	Group 11: Faults 51–54 (P-E7, P-E8, P-E9, P-E10)	0x0000	<input type="radio"/>
P11.47	Fault severity group 17	Group 12: Faults 55–58 (E-Err, ENCU, E-PN, SECAN)	0x0000	<input type="radio"/>
P11.48	Fault severity group 18	Group 13: Faults 59–62 (OT, F1-Er, F2-Er, F3-Er)	0x0000	<input type="radio"/>
P11.49	Fault severity group 19	Group 14: Faults 63–66 (C1-Er, C2-Er, C3-Er, E-CAT)	0x0000	<input type="radio"/>
P11.50	Fault severity group 20	Group 15: Faults 67–70 (E-BAC, E-DEV, S-Err, OtE1) Group 16: Faults 71–75 (OtE2, E-EIP, E-PAO, E-AI1) Group 17: Faults 75–78 (E-AI2, E-AI3, Reserved, Reserved) Group 18: Faults 79–82 (Reserved, Reserved, Reserved, Reserved) Group 19: Faults 83–86 (Reserved, Reserved, Reserved, Reserved) Group 20: Faults 87–90 (Reserved, Reserved, Reserved, Reserved)	0x0000	<input type="radio"/>
P11.51	Action for fault pre-alarm	0–4 0: Run at the set frequency 1: Run at the output frequency at the time of fault 2: Run at the frequency upper limit 3: Run at the frequency lower limit 4: Run at the frequency reserved for exception	0	<input type="radio"/>

Function code	Name	Description	Default value	Modify
P11.52	Frequency reserved for exception	0.00–630.00Hz	0.00Hz	<input type="radio"/>
P11.53	Fire mode function	<p>0–2 0: Invalid 1: Fire mode 1 2: Fire mode 2</p> <p>When P11.53=0, the fire mode is invalid, and the normal running mode is used. In this case, the inverter stops when encountering a fault.</p> <p>When the fire mode function is valid, the inverter runs at the speed specified by P11.54.</p> <p>When fire mode 1 is selected, the inverter always runs except when the inverter has been damaged.</p> <p>When fire mode 2 is selected, the inverter always runs, but the inverter stops when encountering OUT1, OUT2, OUT3, OC1, OC2, OC3, OV1, OV2, OV3, or SPO.</p> <p>Note: Terminal control must be used for a fire mode.</p> <p>When the fire mode has lasted 5 minutes, it is reset, and no warranty of repair is processed.</p>	0	<input checked="" type="radio"/>
P11.54	Running frequency in fire mode	0.00Hz–P00.03 (Max. output frequency)	50.00Hz	<input type="radio"/>
P11.55	Fire mode flag	<p>0–1</p> <p>Note: When the fire mode has lasted 5 minutes, it is reset, and no warranty of repair is processed.</p>	0	<input checked="" type="radio"/>
P11.56	Software detection method for input phase loss	<p>0: Using a sine-wave orthogonal function for detection at 100Hz frequency component</p> <p>1: Using a square-wave orthogonal function for detection at 100Hz frequency component</p>	1	<input type="radio"/>
P11.57	Software detection limited value for input phase loss	Peak value of bus voltage fluctuation at 100Hz frequency component 0–200.0V	40.0V	<input type="radio"/>
P11.58	Software detection time for input phase loss	0–20.0s	2.0s	<input type="radio"/>

P12 group Parameters of motor 2

Function code	Name	Description	Default value	Modify
P12.00	Type of motor 2	0: Asynchronous motor 1: Synchronous motor	0	☉
P12.01	Rated power of asynchronous motor 2	0.1–3000.0kW (4023HP)	Depend on model	☉
P12.02	Rated frequency of asynchronous motor 2	0.01Hz–P00.03 (Max. output frequency)	60.00Hz	☉
P12.03	Rated speed of asynchronous motor 2	1–36000rpm	Depend on model	☉
P12.04	Rated voltage of asynchronous motor 2	0–1200V	Depend on model	☉
P12.05	Rated current of asynchronous motor 2	0.8–6000.0A	Depend on model	☉
P12.06	Stator resistance of asynchronous motor 2	0.001–65.535Ω	Depend on model	○
P12.07	Rotor resistance of asynchronous motor 2	0.001–65.535Ω	Depend on model	○
P12.08	Leakage inductance of asynchronous motor 2	0.1–6553.5mH	Depend on model	○
P12.09	Mutual inductance of asynchronous motor 2	0.1–6553.5mH	Depend on model	○
P12.10	No-load current of asynchronous motor 2	0.1–6553.5A	Depend on model	○
P12.11	Magnetic saturation coefficient 1 of iron core of asynchronous motor 2	0.0–100.0%	80%	○

Function code	Name	Description	Default value	Modify
P12.12	Magnetic saturation coefficient 2 of iron core of asynchronous motor 2	0.0–100.0%	68%	<input type="radio"/>
P12.13	Magnetic saturation coefficient 3 of iron core of asynchronous motor 2	0.0–100.0%	57%	<input type="radio"/>
P12.14	Magnetic saturation coefficient 4 of iron core of asynchronous motor 2	0.0–100.0%	40%	<input type="radio"/>
P12.15	Rated power of synchronous motor 2	0.1–3000.0kW (4023HP)	Depend on model	<input checked="" type="radio"/>
P12.16	Rated frequency of synchronous motor 2	0.01Hz–P00.03 (Max. output frequency)	60.00Hz	<input checked="" type="radio"/>
P12.17	Number of pole pairs of synchronous motor 2	1–128	2	<input checked="" type="radio"/>
P12.18	Rated voltage of synchronous motor 2	0–1200V	Depend on model	<input checked="" type="radio"/>
P12.19	Rated voltage of synchronous motor 2	0.8–6000.0A	Depend on model	<input checked="" type="radio"/>
P12.20	Stator resistance of synchronous motor 2	0.001–65.535Ω	Depend on model	<input type="radio"/>
P12.21	Direct-axis inductance of synchronous motor 2	0.01–655.35mH	Depend on model	<input type="radio"/>

Function code	Name	Description	Default value	Modify
P12.22	Quadrature-axis inductance of synchronous motor 2	0.01–655.35mH	Depend on model	<input type="radio"/>
P12.23	Counter-emf constant of synchronous motor 2	0–10000V	300	<input type="radio"/>
P12.24	Initial pole position of SM 2	0x0000–0xFFFF	0x0000	<input checked="" type="radio"/>
P12.25	Identification current of SM 2	0–50%	10%	<input checked="" type="radio"/>
P12.26	Overload protection of motor 2	0: No protection 1: Common motor (with low-speed compensation) 2: Frequency-variable motor (without low-speed compensation)	2	<input checked="" type="radio"/>
P12.27	Overload protection coefficient of motor 2	Motor overload multiples $M = I_{out}/(I_n \times K)$ I_n is rated motor current, I_{out} is inverter output current, K is motor overload protection coefficient. The smaller the K , the larger the value of M , the easier the protection. When $M=116\%$, protection is performed after motor overload lasts for 1 hour; when $M=150\%$, protection is performed after motor overload lasts for 12 minutes; when $M=180\%$, protection is performed after motor overload lasts for 5 minutes; when $M=200\%$, protection is performed after motor overload lasts for 60 seconds; and when $M \geq 400\%$, protection is performed immediately.	100.0%	<input type="radio"/>

Function code	Name	Description	Default value	Modify
		<p>Setting range: 20.0%–120.0%</p>		
P12.28	Power display calibration coefficient of motor 2	0.00–3.00	1.00	<input type="radio"/>
P12.29	Parameter display of motor 2	0: Display based on the motor type; under this mode, only parameters related to current motor type will be displayed. 1: Display all; under this mode, all the parameters will be displayed.	0	<input type="radio"/>
P12.30	System inertia of motor 2	0–30.000kg ²	0.000	<input type="radio"/>
P12.31–P12.32	Reserved			

P13 group Control parameters of synchronous motor

Function code	Name	Description	Default value	Modify
P13.00	Reduction rate of the injection current of synchronous motor	This parameter is used to set the reduction rate of the input reactive current. When the active current of the synchronous motor increases to some extent, the input reactive current can be reduced to improve the power factor of the motor. Setting range: 0.0%–100.0% (of the rated current of the motor)	80.0%	<input type="radio"/>
P13.01	Initial pole detection mode	0: Disabled 1: In pulse detection mode 2: In pulse detection mode	0	<input checked="" type="radio"/>

Function code	Name	Description	Default value	Modify
P13.02	Input current 1	Input current is the pole position orientation current; input current 1 is valid within the lower limit of input current switch-over frequency threshold. If users need to increase the starting torque, increase the value of this function code properly. Setting range: 0.0%–100.0% (rated motor current)	20.0%	○
P13.03	Input current 2	Input current is the pole position orientation current; input current 2 is valid within the upper limit of input current switch-over frequency threshold, and users do not need to change input current 2 under common situations. Setting range: 0.0%–100.0% (rated motor current)	10.0%	○
P13.04	Switch-over frequency of input current	0.0–200.0% (of the motot rated frequency)	20%	○
P13.05	High-frequency superposition frequency	200Hz–1000Hz	500Hz	◎
P13.06	Pulse current setting	This parameter is used to set the pulse current threshold when the initial magnetic pole position is detected in the pulse mode. The value is a percentage in relative to the rated current of the motor. Setting range: 0.0–300.0% (of the rated voltage of the motor)	100.0%	◎
P13.07	Control parameter 0	0.0–400.0	0.0	○
P13.08	Control parameter 1	0x0000–0xFFFF	0x0000	○
P13.09	Frequency threshold of phase-lock loop switch-in	This parameter is used to set the frequency threshold for enabling the counter-electromotive force phase-locked loop in SVC 0. When the running frequency is lower than the value of this parameter, the phase-locked loop is disabled; and when the running frequency is higher than that, the phase-locked loop is enabled. Setting range: 0–655.35	2.00	○

Function code	Name	Description	Default value	Modify
P13.10	Initial compensation angle of SM	0.0–359.9	0.0	<input type="radio"/>
P13.11	Maladjustment detection time	This parameter is used to adjust the responsiveness of anti-maladjustment function. If the load inertia is large, increase the value of this parameter properly, however, the responsiveness may slow down accordingly. Setting range: 0.0–10.0s	0.5s	<input type="radio"/>
P13.12	High-frequency compensation coefficient of synchronous motor	This parameter is valid when the motor speed exceeds the rated speed. If motor oscillation occurred, adjust this parameter properly. Setting range: 0.0–100.0%	0.0	<input type="radio"/>
P13.13	High-frequency injection current	0–300.0% (of the rated inverter output current)	20.0%	<input checked="" type="radio"/>
P13.14–P13.19	Reserved			

P14 group Serial communication function

Function code	Name	Description	Default value	Modify
P14.00	Local communication address	Setting range: 1–247 When the master is writing frames, and the slave communication address is set to 0, it is the broadcast communication address, and all the slaves on the Modbus/Modbus TCP bus will accept this frame, but the slave never responds. Local communication address is unique in the communication network, which is the basis for point-to-point communication between the upper computer and the inverter. Note: The slave address cannot be set to 0.	1	<input type="radio"/>
P14.01	Communication baud rate setting	This parameter is used to set the data transmission speed between upper computer and the inverter. 0: 1200BPS 1: 2400BPS	4	<input type="radio"/>

Function code	Name	Description	Default value	Modify
		2: 4800BPS 3: 9600BPS 4: 19200BPS 5: 38400BPS 6: 57600BPS 7: 115200BPS Note: Baud rate of the upper computer must be the same with the inverter; otherwise, communication cannot be performed. The larger the baud rate, the faster the communication speed.		
P14.02	Data bit check setting	The data format of upper computer must be the same with the inverter; otherwise, communication cannot be performed. 0: No parity check (N, 8, 1) for RTU 1: Even parity (E, 8, 1) for RTU 2: Odd parity (O, 8, 1) for RTU 3: No parity check (N, 8, 2) for RTU 4: Even parity (E, 8, 2) for RTU 5: Odd parity (O, 8, 2) for RTU	1	<input type="radio"/>
P14.03	Communication response delay	0–200ms It refers to the time interval from when the data is received by the inverter to the moment when the data is sent to the upper computer. If the response delay is less than the system processing time, the response delay will be subject to system processing time; if the response delay is longer than the system processing time, data will be sent to the upper computer at a delay after data process is done by system.	5	<input type="radio"/>
P14.04	Communication timeout period	0.0 (invalid) –60.0s This parameter will be invalid if it is set to 0.0; When it is set to a non-zero value, if the time interval between current communication and the next communication exceeds the communication timeout period, the system will report "485 communication fault" (CE). Under common situations, it is set to 0.0. In systems which have continuous communication,	0.0s	<input type="radio"/>

Function code	Name	Description	Default value	Modify
		users can monitor the communication condition by setting this parameter.		
P14.05	Transmission error processing	0: Alarm and coast to stop 1: Do not alarm and continue running 2: Do not alarm and stop as per the stop mode (under communication control mode only) 3: Do not alarm and stop as per the stop mode (under all control modes)	0	<input type="radio"/>
P14.06	Communication processing action	0x000–0x111 Ones: 0: Write operation has response 1: Write operation has no response Tens: 0: Communication password protection is invalid 1: Communication password protection is valid Hundreds: 0: User-defined addresses of P14.07 and P14.08 are invalid. 1: User-defined addresses of P14.07 and P14.08 are valid.	0x000	<input type="radio"/>
P14.07	User-defined running command address	0x0000–0xFFFF	0x2000	<input type="radio"/>
P14.08	User-defined frequency setting address	0x0000–0xFFFF	0x2001	<input type="radio"/>
P14.09	Modbus TCP communication timeout time	0.0–60.0s	5.0	<input type="radio"/>
P14.10	Enabling program upgrade through RS485	0–1 0: Disable 1: Enable	0	<input checked="" type="radio"/>
P14.11	Bootloader software version	0.00–655.35	0.00	<input checked="" type="radio"/>
P14.12	Displaying no upgrade bootloader fault	0–1 0: Display 1: Do not display	0	<input type="radio"/>
P14.13–P14.47	Reserved			

Function code	Name	Description	Default value	Modify
P14.48	Channel selection for mapping between PZDs and function codes	0x00–0x12 Ones place: Channel for mapping function codes to PZDs 0: Reserved 1: Group P15 2: Group P16 Tens place: Save function at power failure 0: Disable 1: Enable	0x12	<input type="radio"/>
P14.49	Mapped function code of received PZD2	0x0000–0xFFFF	0x0000	<input type="radio"/>
P14.50	Mapped function code of received PZD3	0x0000–0xFFFF	0x0000	<input type="radio"/>
P14.51	Mapped function code of received PZD4	0x0000–0xFFFF	0x0000	<input type="radio"/>
P14.52	Mapped function code of received PZD5	0x0000–0xFFFF	0x0000	<input type="radio"/>
P14.53	Mapped function code of received PZD6	0x0000–0xFFFF	0x0000	<input type="radio"/>
P14.54	Mapped function code of received PZD7	0x0000–0xFFFF	0x0000	<input type="radio"/>
P14.55	Mapped function code of received PZD8	0x0000–0xFFFF	0x0000	<input type="radio"/>
P14.56	Mapped function code of received PZD9	0x0000–0xFFFF	0x0000	<input type="radio"/>
P14.57	Mapped function code of received PZD10	0x0000–0xFFFF	0x0000	<input type="radio"/>
P14.58	Mapped function code of received PZD11	0x0000–0xFFFF	0x0000	<input type="radio"/>
P14.59	Mapped function code of received PZD12	0x0000–0xFFFF	0x0000	<input type="radio"/>

Function code	Name	Description	Default value	Modify
P14.60	Mapped function code of sent PZD2	0x0000–0xFFFF	0x0000	<input type="radio"/>
P14.61	Mapped function code of sent PZD3	0x0000–0xFFFF	0x0000	<input type="radio"/>
P14.62	Mapped function code of sent PZD4	0x0000–0xFFFF	0x0000	<input type="radio"/>
P14.63	Mapped function code of sent PZD5	0x0000–0xFFFF	0x0000	<input type="radio"/>
P14.64	Mapped function code of sent PZD6	0x0000–0xFFFF	0x0000	<input type="radio"/>
P14.65	Mapped function code of sent PZD7	0x0000–0xFFFF	0x0000	<input type="radio"/>
P14.66	Mapped function code of sent PZD8	0x0000–0xFFFF	0x0000	<input type="radio"/>
P14.67	Mapped function code of sent PZD9	0x0000–0xFFFF	0x0000	<input type="radio"/>
P14.68	Mapped function code of sent PZD10	0x0000–0xFFFF	0x0000	<input type="radio"/>
P14.69	Mapped function code of sent PZD11	0x0000–0xFFFF	0x0000	<input type="radio"/>
P14.70	Mapped function code of sent PZD12	0x0000–0xFFFF	0x0000	<input type="radio"/>

P15 group Functions of communication expansion card 1

Function code	Name	Description	Default value	Modify
P15.00	Reserved		0	<input checked="" type="radio"/>
P15.01	Module address	0–127	2	<input checked="" type="radio"/>
P15.02	Received PZD2	0–31	0	<input type="radio"/>
P15.03	Received PZD3	0: Invalid	0	<input type="radio"/>
P15.04	Received PZD4	1: Set frequency (0–Fmax. Unit: 0.01Hz)	0	<input type="radio"/>
P15.05	Received PZD5	2: PID reference (-1000–1000, in which 1000 corresponds to 100.0%)	0	<input type="radio"/>
P15.06	Received PZD6	3: PID feedback (-1000–1000, in which 1000	0	<input type="radio"/>

Function code	Name	Description	Default value	Modify
P15.07	Received PZD7	corresponds to 100.0%)	0	<input type="radio"/>
P15.08	Received PZD8	4: Torque setting (-3000→+3000, in which 1000 corresponds to 100.0% of the motor rated current)	0	<input type="radio"/>
P15.09	Received PZD9	5: Setting of the upper limit of forward running frequency (0–Fmax. Unit: 0.01 Hz)	0	<input type="radio"/>
P15.10	Received PZD10	6: Setting of the upper limit of reverse running frequency (0–Fmax. Unit: 0.01 Hz)	0	<input type="radio"/>
P15.11	Received PZD11	7: Upper limit of electromotive torque (0–3000, in which 1000 corresponds to 100.0% of the motor rated current)	0	<input type="radio"/>
P15.12	Received PZD12	8: Upper limit of braking torque (0–3000, in which 1000 corresponds to 100% of the motor rated current) 9: Virtual input terminal command (Range: 0x000–0x3FF, corresponding to S8/S7/S6/S5/HDIB/HDIA/S4/S3/S2/S1) 10: Virtual output terminal command (Range: 0x00–0x0F, corresponding to RO2/RO1/HDO/Y1) 11: Voltage setting (special for V/F separation) (0–1000, in which 1000 corresponds to 100% of the motor rated voltage) 12: AO1 output setting 1 (-1000→+1000, in which 1000 corresponds to 100.0%) 13: AO2 output setting 2 (-1000–1000, in which 1000 corresponds to 100.0%) 14: High-order bit of position reference (signed) 15: Low-order bit of position reference (unsigned) 16: High-order bit of position feedback (signed) 17: Low-order bit of position feedback (unsigned) 18: Position feedback setting flag (position feedback can be set only after this flag is set to 1 and then to 0) 19: Function parameter mapping (PZD2–PZD12 correspond to P14.49–P14.59) 20–31: Reserved	0	<input type="radio"/>

Function code	Name	Description	Default value	Modify
P15.13	Sent PZD2	0–47	0	<input type="radio"/>
P15.14	Sent PZD3	0: Invalid	0	<input type="radio"/>
P15.15	Sent PZD4	1: Running frequency (x100, Hz)	0	<input type="radio"/>
P15.16	Sent PZD5	2: Set frequency (x100, Hz)	0	<input type="radio"/>
P15.17	Sent PZD6	3: Bus voltage (x10, V)	0	<input type="radio"/>
P15.18	Sent PZD7	4: Output voltage (x1, V)	0	<input type="radio"/>
P15.19	Sent PZD8	5: Output current (x10, A)	0	<input type="radio"/>
P15.20	Sent PZD9	6: Actual output torque (x10, %)	0	<input type="radio"/>
P15.21	Sent PZD10	7: Actual output power (x10, %)	0	<input type="radio"/>
P15.22	Sent PZD11	8: Rotation speed of running (x1, RPM)	0	<input type="radio"/>
		9: Linear speed of running (x1, m/s)	0	<input type="radio"/>
		10: Ramp reference frequency	0	<input type="radio"/>
P15.23	Sent PZD12	11: Fault code 12: AI1 input (x100, V) 13: AI2 input (x100, V) 14: AI3 input (x100, V) 15: HDIA frequency value (x100, kHz) 16: Terminal input status 17: Terminal output status 18: PID reference (x100, %) 19: PID feedback (x100, %) 20: Motor rated torque 21: High-order bit of position reference (signed) 22: Low-order bit of position reference (unsigned) 23: High-order bit of position feedback (signed) 24: Low-order bit of position feedback (unsigned) 25: Status word 26: HDIB frequency value (x100, kHz) 27: High-order bit of PG card pulse feedback 28: Low-order bit of PG card pulse feedback 29: High-order bit of PG card pulse reference 30: Low-order bit of PG card pulse reference 31: Function parameter mapping (PZD2–PZD12 correspond to P14.60–P14.70) 32: Inverter status word 3 33–47: Reserved	0	<input type="radio"/>
		Note: Each bit of "32: Inverter status word 3" is		

Function code	Name	Description	Default value	Modify
		described as follows: bit0: Jogging bit1: Frequency level detection FDT1 bit2: Frequency level detection FDT2 bit3: Frequency reached bit4: Running at zero speed bit5: Upper limit frequency reached bit6: Lower limit frequency reached bit7: Pre-exciting bit8: Underload pre-alarm bit9: Simple PLC stage completed bit10: Simple PLC cycle completed bit11: Positioning completed bit12: Spindle zeroing completed bit13: Spindle scale division completed bit14: Speed being limited bit15: Speed/position control switchover completed		
P15.24	Reserved			
P15.25	DP communication timeout time	0.0 (invalid)–60.0s	5.0	○
P15.26	CANopen communication timeout time	0.0 (invalid)–60.0s	5.0	○
P15.27	CANopen communication baud rate	0–7 0: 1000kbps 1: 800kbps 2: 500kbps 3: 250kbps 4: 125kbps 5: 100kbps 6: 50kbps 7: 20kbps	3	◎
P15.28	Master/slave CAN communication address	0–127	1	◎
P15.29	Master/slave CAN communication baud rate selection	0: 50Kbps 1: 100 Kbps 2: 125Kbps 3: 250Kbps 4: 500Kbps 5: 1M bps	2	◎

Function code	Name	Description	Default value	Modify
P15.30	Master/slave CAN communication timeout period	0.0 (invalid)–300.0s	0.0s	<input type="radio"/>
P15.31–P15.42	Reserved			
P15.43	Format of communication control word	0–1 0: Decimal format 1: Binary format	0	<input checked="" type="radio"/>
P15.44	G500XLT timeout time	0.0–60.0s	0.0s	<input type="radio"/>

P16 group Functions of communication expansion card 2

Function code	Name	Description	Default value	Modify
P16.00	Reserved			
P16.01	Reserved			
P16.02	Ethernet monitoring card IP address 1	0–255	192	<input checked="" type="radio"/>
P16.03	Ethernet monitoring card IP address 2	0–255	168	<input checked="" type="radio"/>
P16.04	Ethernet monitoring card IP address 3	0–255	0	<input checked="" type="radio"/>
P16.05	Ethernet monitoring card IP address 4	0–255	1	<input checked="" type="radio"/>
P16.06	Ethernet monitoring card subnet mask 1	0–255	255	<input checked="" type="radio"/>
P16.07	Ethernet monitoring card subnet mask 2	0–255	255	<input checked="" type="radio"/>
P16.08	Ethernet monitoring card subnet mask 3	0–255	255	<input checked="" type="radio"/>
P16.09	Ethernet monitoring card subnet mask 4	0–255	0	<input checked="" type="radio"/>

Function code	Name	Description	Default value	Modify
P16.10	Ethernet monitoring card gateway 1	0–255	192	☉
P16.11	Ethernet monitoring card gateway 2	0–255	168	☉
P16.12	Ethernet monitoring card gateway 3	0–255	0	☉
P16.13	Ethernet monitoring card gateway 4	0–255	1	☉
P16.14	Ethernet monitoring variable address 1	0x0000–0xFFFF	0x0000	○
P16.15	Ethernet monitoring variable address 2	0x0000–0xFFFF	0x0000	○
P16.16	Ethernet monitoring variable address 3	0x0000–0xFFFF	0x0000	○
P16.17	Ethernet monitoring variable address 4	0x0000–0xFFFF	0x0000	○
P16.18– P16.23	Reserved	/	/	/
P16.24	Identification time for the expansion card in card slot 1	0.0–600.0s If it is set to 0.0, identification fault will not be detected	0.0s	0.0
P16.25	Identification time for the expansion card in card slot 2	0.0–600.0s If it is set to 0.0, offline fault will not be detected	0.0s	0.0
P16.26	Identification time for the expansion card in card slot 3	0.0–600.0s If it is set to 0.0, offline fault will not be detected	0.0s	/
P16.27	Communication timeout period of expansion card in card slot 1	0.0–600.0s If it is set to 0.0, offline fault will not be detected	0.0s	/

Function code	Name	Description	Default value	Modify
P16.28	Communication timeout period of expansion card in card slot 2	0.0–600.0s If it is set to 0.0, offline fault will not be detected	0.0s	/
P16.29	Communication timeout period of expansion card in card slot 3	0.0–600.0s If it is set to 0.0, offline fault will not be detected	0.0s	/
P16.30	Reserved	/	/	/
P16.31	PROFINET communication timeout time	0.0–60.0s	5.0s	○
P16.32	Received PZD2	0–31	0	○
P16.33	Received PZD3	0: Invalid	0	○
P16.34	Received PZD4	1: Set frequency (0–Fmax. Unit: 0.01Hz)	0	○
P16.35	Received PZD5	2: PID reference (-1000–1000, in which 1000 corresponds to 100.0%)	0	○
P16.36	Received PZD6	3: PID feedback (-1000–1000, in which 1000 corresponds to 100.0%)	0	○
P16.37	Received PZD7	4: Torque setting (-3000–+3000, in which 1000 corresponds to 100.0% of the motor rated current)	0	○
P16.38	Received PZD8		0	○
P16.39	Received PZD9		0	○
P16.40	Received PZD10	5: Setting of the upper limit of forward running frequency (0–Fmax. Unit: 0.01 Hz)	0	○
P16.41	Received PZD11	6: Setting of the upper limit of reverse running frequency (0–Fmax. Unit: 0.01 Hz)	0	○
P16.42	Received PZD12	7: Upper limit of electromotive torque (0–3000, in which 1000 corresponds to 100.0% of the motor rated current) 8: Upper limit of braking torque (0–3000, in which 1000 corresponds to 100% of the motor rated current) 9: Virtual input terminal command (Range: 0x000–0x3FF, corresponding to S8/S7/S6/S5/HDIB/HDIA/S4/S3/S2/S1) 10: Virtual output terminal command (Range: 0x00–0x0F, corresponding to RO2/RO1/HDO/Y1) 11: Voltage setting (special for V/F separation)	0	○

Function code	Name	Description	Default value	Modify
		(0–1000, in which 1000 corresponds to 100% of the motor rated voltage) 12: AO1 output setting 1 (-1000+1000, in which 1000 corresponds to 100.0%) 13: AO2 output setting 2 (-1000–1000, in which 1000 corresponds to 100.0%) 14: High-order bit of position reference (signed) 15: Low-order bit of position reference (unsigned) 16: High-order bit of position feedback (signed) 17: Low-order bit of position feedback (unsigned) 18: Position feedback setting flag (position feedback can be set only after this flag is set to 1 and then to 0) 19: Function parameter mapping (PZD2–PZD12 correspond to P14.49–P14.59) 20–31: Reserved		
P16.43	Sent PZD2	0–47	0	<input type="radio"/>
P16.44	Sent PZD3	0: Invalid	0	<input type="radio"/>
P16.45	Sent PZD4	1: Running frequency (x100, Hz)	0	<input type="radio"/>
P16.46	Sent PZD5	2: Set frequency (x100, Hz)	0	<input type="radio"/>
P16.47	Sent PZD6	3: Bus voltage (x10, V)	0	<input type="radio"/>
P16.48	Sent PZD7	4: Output voltage (x1, V)	0	<input type="radio"/>
P16.49	Sent PZD8	5: Output current (x10, A)	0	<input type="radio"/>
P16.50	Sent PZD9	6: Actual output torque (x10, %)	0	<input type="radio"/>
P16.51	Sent PZD10	7: Actual output power (x10, %)	0	<input type="radio"/>
P16.52	Sent PZD11	8: Rotation speed of running (x1, RPM)	0	<input type="radio"/>
		9: Linear speed of running (x1, m/s)	0	<input type="radio"/>
		10: Ramp reference frequency	0	<input type="radio"/>
P16.53	Sent PZD12	11: Fault code	0	<input type="radio"/>
		12: AI1 input (x100, V)		
		13: AI2 input (x100, V)		
		14: AI3 input (x100, V)		
		15: HDIA frequency value (x100, kHz)		
		16: Terminal input status		
		17: Terminal output status		
		18: PID reference (x100, %)		
		19: PID feedback (x100, %)		
		20: Motor rated torque		

Function code	Name	Description	Default value	Modify
		21: High-order bit of position reference (signed) 22: Low-order bit of position reference (unsigned) 23: High-order bit of position feedback (signed) 24: Low-order bit of position feedback (unsigned) 25: Status word 26: HDIB frequency value (x100, kHz) 27: High-order bit of PG card pulse feedback 28: Low-order bit of PG card pulse feedback 29: High-order bit of PG card pulse reference 30: Low-order bit of PG card pulse reference 31: Function parameter mapping (PZD2–PZD12 correspond to P14.60–P14.70) 32: Inverter status word 3 Note: Each bit of "32: Inverter status word 3" is described as follows: bit0: Jogging bit1: Frequency level detection FDT1 bit2: Frequency level detection FDT2 bit3: Frequency reached bit4: Running at zero speed bit5: Upper limit frequency reached bit6: Lower limit frequency reached bit7: Pre-exciting bit8: Underload pre-alarm bit9: Simple PLC stage completed bit10: Simple PLC cycle completed bit11: Positioning completed bit12: Spindle zeroing completed bit13: Spindle scale division completed bit14: Speed being limited bit15: Speed/position control switchover completed		
P16.54	Ethernet IP communication timeout time	0.0–60.0s	5.0s	○
P16.55	Ethernet IP communication rate	0–4 0: Self-adaptive 1: 100M full-duplex 2: 100M half-duplex	0	◎

Function code	Name	Description	Default value	Modify
		3: 10M full-duplex 4: 10M half-duplex		
P16.56	Bluetooth pairing code	0-65535	0	●
P16.57	Bluetooth host type	0-65535 0: No host connection 1: Mobile APP 2: Bluetooth box 3-65535: Reserved	0	●
P16.58	Industrial Ethernet communication card IP address 1	0-255	192	◎
P16.59	Industrial Ethernet communication card IP address 2	0-255	168	◎
P16.60	Industrial Ethernet communication card IP address 3	0-255	0	◎
P16.61	Industrial Ethernet communication card IP address 4	0-255	20	◎
P16.62	Industrial Ethernet communication card subnet mask 1	0-255	255	◎
P16.63	Industrial Ethernet communication card subnet mask 2	0-255	255	◎
P16.64	Industrial Ethernet communication card subnet mask 3	0-255	255	◎
P16.65	Industrial Ethernet communication card subnet mask 4	0-255	0	◎
P16.66	Industrial Ethernet communication card gateway 1	0-255	192	◎

Function code	Name	Description	Default value	Modify
P16.67	Industrial Ethernet communication card gateway 2	0–255	168	☉
P16.68	Industrial Ethernet communication card gateway 3	0–255	0	☉
P16.69	Industrial Ethernet communication card gateway 4	0–255	1	☉
P16.70	G500ETH timeout time	0.0–60.0s	0.0	○

P17 group State-check functions

Function code	Name	Description	Default value	Modify
P17.00	Set frequency	Display current set frequency of the inverter. Range: 0.00Hz–P00.03	0.00Hz	●
P17.01	Output frequency	Display current output frequency of the inverter. Range: 0.00Hz–P00.03	0.00Hz	●
P17.02	Ramps reference frequency	Display current ramps reference frequency of the inverter. Range: 0.00Hz–P00.03	0.00Hz	●
P17.03	Output voltage	Display current output voltage of the inverter. Range: 0–1200V	0V	●
P17.04	Output current	Display the valid value of current output current of the inverter. Range: 0.0–5000.0A	0.0A	●
P17.05	Motor speed	Display current motor speed. Range: 0–65535RPM	0 RPM	●
P17.06	Torque current	Display current torque current of the inverter. Range: -3000.0–3000.0A	0.0A	●
P17.07	Existing current	Display current existing current of the inverter. Range: -3000.0–3000.0A	0.0A	●
P17.08	Motor power	Display current motor power; 100% relative to rated motor power, positive value is motoring state, negative value is generating state. Range: -300.0–300.0% (relative to rated motor power)	0.0%	●

Function code	Name	Description	Default value	Modify
P17.09	Motor output torque	Display current output torque of the inverter; 100% relative to rated motor torque, during forward running, positive value is motoring state, negative value is generating state, during reverse running, positive value is generating state, negative value is motoring state. Range: -250.0–250.0%	0.0%	●
P17.10	Estimated motor frequency	The estimated motor rotor frequency under open-loop vector condition. Range: 0.00– P00.03	0.00Hz	●
P17.11	DC bus voltage	Display current DC bus voltage of the inverter. Range: 0.0–2000.0V	0.0V	●
P17.12	Digital input terminal state	Display current digital input terminal state of the inverter. 0x00–0x3F Corresponds to HDIB, HDIA, S4, S3, S2 and S1 respectively	0x00	●
P17.13	Digital output terminal state	Display current digital output terminal state of the inverter. 0x00–0x0F Corresponds to R02, RO1, HDO and Y1 respectively	0x00	●
P17.14	Digital adjustment variable	Display the regulating variable by UP/DOWN terminals of the inverter. Range: 0.00Hz–P00.03	0.00Hz	●
P17.15	Torque reference value	Relative to percentage of the rated torque of current motor, display torque reference. Range: -300.0%–300.0% (rated motor current)	0.0%	●
P17.16	Linear speed	0–65535	0	●
P17.17	Reserved	0–65535	0	●
P17.18	Count value	0–65535	0	●
P17.19	AI1 input voltage	Display input signal of AI 1 Range: 0.00–10.00V	0.00V	●
P17.20	AI2 input voltage	Display input signal of AI2 Range: -10.00V–10.00V	0.00V	●
P17.21	HDIA input frequency	Display input frequency of HDIA Range: 0.000–50.000kHz	0.000 kHz	●

Function code	Name	Description	Default value	Modify
P17.22	HDIB input frequency	Display input frequency of HDIB Range: 0.000–50.000kHz	0.000 kHz	●
P17.23	PID reference value	Display PID reference value Range: -100.0–100.0%	0.0%	●
P17.24	PID feedback value	Display PID feedback value Range: -100.0–100.0%	0.0%	●
P17.25	Motor power factor	Display the power factor of current motor. Range: -1.00–1.00	0.00	●
P17.26	Current running time	Display current running time of the inverter. Range: 0–65535min	0m	●
P17.27	Simple PLC and current step number of multi-step speed	Display simple PLC and current step number of multi-step speed Range: 0–15	0	●
P17.28	Motor ASR controller output	Display the speed loop ASR controller output value under vector control mode, relative to the percentage of rated torque of the motor. Range: -300.0%–300.0% (rated motor current)	0.0%	●
P17.29	Pole angle of open-loop synchronous motor	Display initial identification angle of synchronous motor Range: 0.0–360.0	0.0	●
P17.30	Phase compensation of synchronous motor	Display phase compensation of synchronous motor Range: -180.0–180.0	0.0	●
P17.31	High-frequency superposition current of synchronous motor	0.0%–200.0% (rated motor current)	0.0	●
P17.32	Motor flux linkage	0.0%–200.0%	0.0%	●
P17.33	Existing current reference	Display the existing current reference value under vector control mode Range: -3000.0–3000.0A	0.0A	●
P17.34	Torque current reference	Display torque current reference value under vector control mode Range: -3000.0–3000.0A	0.0A	●

Function code	Name	Description	Default value	Modify
P17.35	AC incoming current	Display the valid value of incoming current on AC side Range: 0.0–5000.0A	0.0A	●
P17.36	Output torque	Display output torque value, during forward running, positive value is motoring state, negative value is generating state; during reverse running, positive value is generating state, negative value is motoring state. Range: -3000.0Nm–3000.0Nm	0.0Nm	●
P17.37	Motor overload count value	0–65535	0	●
P17.38	Process PID output	-100.0%–100.0%	0.0%	●
P17.39	Parameter download wrong function code	0.00–99.00	0.00	●
P17.40	Motor control mode	Range: 0x000–0x123 Ones: Control mode 0: Vector 0 1: Vector 1 2: SVPWM control 3: FVC Tens: Control state 0: Speed control 1: Torque control Hundreds: Motor number 0: Motor 1 1: Motor 2	0x000	●
P17.41	Upper limit of the torque when motoring	0.0%–300.0% (rated motor current)	0.0%	●
P17.42	Upper limit of brake torque	0.0%–300.0% (rated motor current)	0.0%	●
P17.43	Upper limit frequency of forward running of torque control	0.00–P00.03	0.00Hz	●
P17.44	Upper limit frequency of reverse running of torque control	0.00–P00.03	0.00Hz	●

Function code	Name	Description	Default value	Modify
P17.45	Inertia compensation torque	-100.0%–100.0%	0.0%	●
P17.46	Friction compensation torque	-100.0%–100.0%	0.0%	●
P17.47	Motor pole pairs	0–65535	0	●
P17.48	Inverter overload count value	0–65535	0	●
P17.49	Frequency set by A source	0.00–P00.03	0.00Hz	●
P17.50	Frequency set by B source	0.00–P00.03	0.00Hz	●
P17.51	PID proportional output	-100.0%–100.0%	0.0%	●
P17.52	PID integral output	-100.0%–100.0%	0.0%	●
P17.53	PID differential output	-100.0%–100.0%	0.0%	●
P17.54	Current PID proportional gain	0.00–100.00	0.00	●
P17.55	Current PID integral time	0.00–100.00s	0.00%	●
P17.56	Current PID differential time	0.00–100.00s	0.00%	●
P17.57	Current step of multi-step speed	0–15	0	●
P17.58	Peak-to-peak value at 100Hz frequency component (square-wave orthogonal function detected)	0.0–300.0V Peak-to-peak value of bus voltage fluctuation at 100Hz frequency component, which is detected by using a square-wave orthogonal function	0.0V	●
P17.59	Peak-to-peak value at 100Hz frequency component (sine-wave orthogonal function detected)	0.0–300.0V Peak-to-peak value of bus voltage fluctuation at 100Hz frequency component, which is detected by using a sine-wave orthogonal function	0.0V	●

P18 group Closed-loop control state check

Function code	Name	Description	Default value	Modify
P18.00	Actual frequency of encoder	The actual-measured encoder frequency; the value of forward running is positive; the value of reverse running is negative. Range: -999.9–3276.7Hz	0.0Hz	●
P18.01	Encoder position count value	Encoder count value, quadruple frequency, Range: 0–65535	0	●
P18.02	Encoder Z pulse count value	Corresponding count value of encoder Z pulse. Range: 0–65535	0	●
P18.03	High bit of position reference value	High bit of position reference value, zero out after stop. Range: 0–30000	0	●
P18.04	Low bit of position reference value	Low bit of position reference value, zero out after stop. Range: 0–65535	0	●
P18.05	High bit of position feedback value	High bit of position feedback value, zero out after stop. Range: 0–30000	0	●
P18.06	Low bit of position feedback value	Low bit of position feedback value, zero out after stop. Range: 0–65535	0	●
P18.07	Position deviation	Deviation between current reference position and actual running position. Range: -32768–32767	0	●
P18.08	Position of position reference point	Position of reference point of Z pulse when the spindle stops accurately. Range: 0–65535	0	●
P18.09	Current position setting of spindle	Current position setting when the spindle stops accurately. Range: 0–359.99	0.00	●
P18.10	Current position when spindle stops accurately	Current position when spindle stops accurately. Range: 0–65535	0	●
P18.11	Encoder Z pulse direction	Z pulse direction display. When the spindle stops accurately, there may be a couple of pulses' error between the position of forward and reverse orientation, which can be eliminated by adjusting Z pulse direction of P20.02 or exchanging phase AB of encoder. 0: Forward 1: Reverse	0	●

Function code	Name	Description	Default value	Modify
P18.12	Encoder Z pulse angle	Reserved. Range: 0.00–359.99	0.00	●
P18.13	Encoder Z pulse error times	Reserved. Range: 0–65535	0	●
P18.14	High bit of encoder pulse count value	0–65535	0	●
P18.15	Low bit of encoder pulse count value	0–65535	0	●
P18.16	Reserved			
P18.17	Pulse command frequency	Pulse command (A2, B2 terminal) is converted to the set frequency, and it is valid under pulse position mode and pulse speed mode. Range: -3276.8–3276.7Hz	0.0Hz	●
P18.18	Pulse command feedforward	Pulse command (A2, B2 terminal) is converted to the set frequency, and it is valid under pulse position mode and pulse speed mode. Range: -3276.8–3276.7Hz	0.0Hz	●
P18.19	Position regulator output	The output frequency of the position regulator during position control. Range: -3276.8–3276.7Hz	0.0	●
P18.20	Count value of resolver	Count value of resolver. Range: 0–65535	0	●
P18.21	Resolver angle	The pole position angle read according to the resolver-type encoder. Range: 0.00–359.99	0.00	●
P18.22	Pole angle of closed-loop synchronous motor	Current pole position. Range: 0.00–359.99	0.00	●
P18.23	State control word 3	0x0000–0xFFFF	0x0000	●
P18.24	High bit of count value of pulse reference	0–65535	0	●
P18.25	Low bit of count value of pulse reference	0–65535	0	●
P18.26	PG card measured speed value	-3276.8–3276.7Hz	0.0	●
P18.27	Encoder UVW sector	0–7	0	●

Function code	Name	Description	Default value	Modify
P18.28	Encoder PPR (pulse-per-revolution) display	0–65535	0	●
P18.29	Angle compensation value of synchronous motor	-180.0–180.0	0.00	●
P18.30	Z pulse angle of SM	0.00–655.35	0.00	●
P18.31	Pulse reference Z pulse value	0–65535	0	●
P18.32	Pulse-given main control board measured speed value	-3276.8–3276.7Hz	0.0Hz	●
P18.33	Pulse-given PG card measured speed value	-3276.8–3276.7Hz	0.0Hz	●
P18.34	Present encoder filter width	0–63	0	●
P18.35	8k test duration	0–65535	0	●

P19 group Expansion card state check

Function code	Name	Description	Default value	Modify
P19.00	State of card slot 1	0–65535 0: No card 1: PLC programmable card 2: I/O card 3: Incremental PG card 4: Incremental PG card with UVW 5: Ethernet communication card 6: DP communication card 7: Bluetooth card 1 8: Resolver PG card 9: CANopen communication card 10: WIFI card	0	●
P19.01	State of card slot 2		0	●
P19.02	State of card slot 3		0	●

Function code	Name	Description	Default value	Modify
		11: PROFINET communication card 12: Sine/Cosine PG card without CD signal 13: Sine/Cosine PG card with CD signal 14: Absolute encoder PG card 15: CAN master/slave communication card 16: Modbus TCP communication card 17: EtherCAT communication card 18: BacNet communication card 19: DeviceNet communication card 20: PT100/PT1000 temperature detection card 21: EtherNet IP communication card 22: MECHATROLINK communication card 23: Bluetooth card 2 254: G500XLT card 255: G500ETH card		
P19.03	Software version of the expansion card in card slot 1	0.00–655.35	0.00	●
P19.04	Software version of the expansion card in card slot 2	0.00–655.35	0.00	●
P19.05	Software version of the expansion card in card slot 3	0.00–655.35	0.00	●
P19.06	Input state of extension I/O card terminals	0x0000–0xFFFF	0x0000	●
P19.07	Output state of extension I/O card terminals	0x0000–0xFFFF	0x0000	●
P19.08	HDI3 input frequency of extension I/O card	0.000–50.000kHz	0.000 kHz	●
P19.09	AI3 input voltage of extension I/O card	0.00–10.00V	0.00V	●
P19.10	EC PT100 detected temperature	-50.0–150.0°C	0.0°C	●

Function code	Name	Description	Default value	Modify
P19.11	EC PT100 detected digital	0–4096	0	●
P19.12	EC PT1000 detected temperature	-50.0–150.0°C	0.0°C	●
P19.13	EC PT1000 detected digital	0–4096	0	●
P19.14	Alarm display	0–4 0: No alarm 1: PT100 detected OH alarm (A-Ot1) 2: PT1000 detected OH alarm (A-Ot2) 3: PT100 disconnection alarm (A-Pt1) 4: PT1000 disconnection alarm (A-Pt2)	0	●
P19.15	Inverter control word	0–65535	0	●
P19.16	Inverter status word	0–65535	0	●
P19.17	Ethernet monitoring variable 1	0–65535	0	●
P19.18	Ethernet monitoring variable 2	0–65535	0	●
P19.19	Ethernet monitoring variable 3	0–65535	0	●
P19.20	Ethernet monitoring variable 4	0–65535	0	●
P19.21	AI/AO detected temperature	-20.0–200.0°C	0.0°C	●
P19.22	Variable address of speed reference calibration value	0x0000–0xFFFF	0x0000	●
P19.23	Variable address of speed feedback calibration value	0x0000–0xFFFF	0x0000	●

P20 group Encoder of motor 1

Function code	Name	Description	Default value	Modify
P20.00	Encoder type display	0: Incremental encoder 1: Resolver-type encoder 2: Sin/Cos encoder 3: Endat absolute encoder	0	●
P20.01	Encoder pulse number	Number of pulses generated when the encoder revolves for one circle. Setting range: 0–60000	1024	◎
P20.02	Encoder direction	Ones: AB direction 0: Forward 1: Reverse Tens: Z pulse direction (reserved) 0: Forward 1: Reverse Hundreds: CD/UVW pole signal direction 0: Forward 1: Reverse	0x000	◎
P20.03	Detection time of encoder offline fault	The detection time of encoder offline fault. Setting range: 0.0–10.0s	2.0s	○
P20.04	Detection time of encoder reversal fault	Detection time of encoder reversal fault. Setting range: 0.0–100.0s	0.8s	○
P20.05	Filter times of encoder detection	Setting range: 0x00–0x99 Ones: Low-speed filter time, corresponds to $2^{(0-9)} \times 125\mu\text{s}$. Tens: High-speed filter times, corresponds to $2^{(0-9)} \times 125\mu\text{s}$.	0x33	○
P20.06	Speed ratio between encoder mounting shaft and motor	Users need to set this parameter when the encoder is not installed on the motor shaft and the drive ratio is not 1. Setting range: 0.001–65.535	1.000	○
P20.07	Control parameters of synchronous motor	Bit0: Enable Z pulse calibration Bit1: Enable encoder angle calibration Bit2: Enable SVC speed measurement Bit3: Reserved Bit4: Reserved	0x0003	○

Function code	Name	Description	Default value	Modify
		Bit5: Reserved Bit6: Enable CD signal calibration Bit7: Reserved Bit8: Do not detect encoder fault during autotuning Bit9: Enable Z pulse detection optimization Bit10: Enable initial Z pulse calibration optimization Bit12: Clear Z pulse arrival signal after stop		
P20.08	Enable Z pulse offline detection	0x00–0x11 Ones: Z pulse 0: Do not detect 1: Enable Tens: UVW pulse (for synchronous motor) 0: Do not detect 1: Enable	0x10	○
P20.09	Initial angle of Z pulse	Relative electric angle of encoder Z pulse and motor pole position. Setting range: 0.00–359.99	0.00	○
P20.10	Initial angle of the pole	Relative electric angle of encoder position and motor pole position. Setting range: 0.00–359.99	0.00	○
P20.11	Autotuning of initial angle of pole	0–3 1: Rotary autotuning (DC brake) 2: Static autotuning (suitable for resolver-type encoder, sin/cos with CD signal feedback) 3: Rotary autotuning (initial angle identification)	0	◎
P20.12	Speed measurement optimization selection	0: No optimization 1: Optimization mode 1 2: Optimization mode 2	1	◎
P20.13	CD signal zero offset gain	0–65535	0	○
P20.14	Encoder type selection	Ones: Incremental encoder 0: without UVW 1: with UVW Tens: Sin/Cos encoder	0x00	◎

Function code	Name	Description	Default value	Modify
		0: without CD signal 1: with CD signal		
P20.15	Speed measurement mode	0: PG card 1: local; realized by HDIA and HDIB; supports incremental 24V encoder only	0	☉
P20.16	Frequency-division coefficient	0–255 When this parameter is set to 0 or 1, frequency division of 1:1 is implemented.	0	○
P20.17	Pulse filter processing	0x0000–0xFFFF Bit0: Enable/disable encoder input filter 0: No filter 1: Filter Bit1: Encoder signal filter mode (set Bit0 or Bit2 to 1) 0: Self-adaptive filter 1: Use P20.18 filter parameters Bit2: Enable/disable encoder frequency-division output filter 0: No filter 1: Filter Bit3: Reserved Bit4: Enable/disable pulse reference filter 0: No filter 1: Filter Bit5: Pulse reference filter mode (valid when Bit4 is set to 1) 0: Self-adaptive filter 1: Use P20.19 filter parameters Bit6: Frequency-divided output source setting (valid only for incremental encoders) 0: Encoder signals 1: Pulse reference signals Bits7–15: Reserved	0x0033	○
P20.18	Encoder pulse filter width	0–63 The filtering time is $P20.18 \times 0.25 \mu s$. The value 0 or 1 indicates $0.25 \mu s$.	2	○
P20.19	Pulse reference filter width	0–63 The filtering time is $P20.18 \times 0.25 \mu s$. The value 0 or 1 indicates $0.25 \mu s$.	2	○

Function code	Name	Description	Default value	Modify
P20.20	Pulse number of pulse reference	0–65535	1024	<input checked="" type="radio"/>
P20.21	Enable angle compensation of synchronous motor	0–1	1	<input type="radio"/>
P20.22	Switch-over frequency threshold of speed measurement mode	0–630.00Hz Note: This parameter is valid only when P20.12 is set to 0.	1.00Hz	<input type="radio"/>
P20.23	Synchronous motor angle compensation coefficient	-200.0–200.0%	100.0%	<input type="radio"/>
P20.24	Number of pole pairs in initial magnetic pole angle autotuning	1–128	2	<input checked="" type="radio"/>

P21 group Position control

Function code	Name	Description	Default value	Modify
P21.00	Positioning mode	Range: 0x0000–0x7121 Ones: Control mode selection 0: Speed control 1: Position control Tens: Position command source 0: Pulse string 1: Digital position 2: Positioning of photoelectric switch during stop Hundreds: Position feedback source (reserved, fixed to channel P) 0: PG1 1: PG2 Thousands: servo mode Bit0: Position deviation mode 0: No deviation 1: With deviation	0x0000	<input type="radio"/>

Function code	Name	Description	Default value	Modify
		Bit1: Enable/disable servo 0: Disable (The servo can be enabled by terminals.) 1: Enable Bit2: (reserved) Note: In the pulse string or spindle positioning mode, the inverter enters the servo operation mode when there is a valid servo enabling signal. If there is no servo enabling signal, the inverter enters the servo operation mode only after it receives a forward running or reverse running command.		
P21.01	Pulse command mode	Range: 0x0000–0x3133 Ones: Pulse mode 0: A/B quadrature pulse; A precedes B 1: A: PULSE; B: SIGN If channel B is of low electric level, the edge counts up; if channel B is of high electric level, the edge counts down. 2: A: Positive pulse Channel A is positive pulse; channel B needs no wiring 3: A/B dual-channel pulse; channel A pulse edge counts up, channel B pulse edge counts down Tens: Pulse direction Bit0: Set pulse direction 0: Forward 1: Reverse Bit1: Set pulse direction by running direction 0: Disable, and BIT0 is valid; 1: Enable Hundreds: Pulse/direction frequency-doubling selection (reserved) 0: No frequency-doubling 1: Frequency-doubling Thousands: Pulse control selection Bit0: Pulse filter selection 0: Inertia filter 1: Average moving filter	0x0000	©

Function code	Name	Description	Default value	Modify
		Bit1: Overspeed control 0: No control 1: Control		
P21.02	APR gain 1	The two automatic position regulator (APR) gains are switched based on the switching mode set in P21.04. When the spindle orientation function is used, the gains are switched automatically, regardless of the setting of P21.04. P21.03 is used for dynamic running, and P21.02 is used for maintaining the locked state. Setting range: 0.0–400.0	20.0	<input type="radio"/>
P21.03	APR gain 2		30.0	<input type="radio"/>
P21.04	Switching mode of position loop gain	This parameter is used to set the APR gain switching mode. To use torque command-based switching, you need to set P21.05; and to use speed command-based switching, you need to set P21.06. 0: No switching 1: Torque command 2: Speed command 3–5: Reserved	0	<input type="radio"/>
P21.05	Torque command level during position gain switch-over	0.0–100.0% (rated motor torque)	10.0%	<input type="radio"/>
P21.06	Speed command level during position gain switch-over	0.0–100.0% (rated motor speed)	10.0%	<input type="radio"/>
P21.07	Smooth filter coefficient during gain switch-over	The smooth filter coefficient during position gain switch-over. Setting range: 0–15	5	<input type="radio"/>
P21.08	Output limit of position controller	The output limit of position regulator, if the limit value is 0, position regulator will be invalid, and no position control can be performed, however, speed control is available. Setting range: 0.0–100.0% (Max. output frequency P00.03)	20.0%	<input type="radio"/>

Function code	Name	Description	Default value	Modify
P21.09	Completion range of positioning	When the position deviation is less than P21.09, and the duration is larger than P21.10, positioning completion signal will be outputted. Setting range: 0–1000	10	<input type="radio"/>
P21.10	Detection time for positioning completion	0.0–1000.0ms	10.0ms	<input type="radio"/>
P21.11	Numerator of position command ratio	Electronic gear ratio, used to adjust the corresponding relation between position command and actual running displacement. Setting range: 1–65535	1000	<input type="radio"/>
P21.12	Denominator of position command ratio	Setting range: 1–65535	1000	<input type="radio"/>
P21.13	Position feedforward gain	0.00–120.00% For pulse string reference only (position control)	100.00	<input type="radio"/>
P21.14	Position feedforward filter time constant	0.0–3200.0ms For pulse string reference only (position control)	3.0ms	<input type="radio"/>
P21.15	Position command filter time constant	The position feedforward filter time constant during pulse string positioning. 0.0–3200.0ms	0.0ms	<input checked="" type="radio"/>
P21.16	Digital positioning mode	Range: 0x0000–0xFFFF Bit0: Positioning mode selection 0: Relative position 1: Absolute position (home) (reserved) Bit1: Positioning cycle selection 0: Cyclic positioning by terminals 1: Automatic cyclic positioning Bit2: Cycle mode 0: Continuous 1: Repetitive (supported by automatic cyclic positioning only) Bit3: P21.17 digital setting mode 0: Incremental 1: Position type (do not support continuous mode) Bit4: Home searching mode 0: Search for the home just once	0x0000	<input type="radio"/>

Function code	Name	Description	Default value	Modify
		1: Search for the home during each run Bit5: Home calibration mode 0: Calibrate in real time 1: Single calibration Bit6: Positioning completion signal selection 0: Valid during the time set by P21.25 (Hold time of positioning completion signal) 1: Always valid Bit7: Initial positioning selection (for cyclic positioning by terminals) 0: Invalid (do not rotate) 1: Valid Bit8: Positioning enable signal selection (for cyclic positioning by terminals only; positioning function is always enabled for automatic cyclic positioning) 0: Pulse signal 1: Level signal Bit9: Position source 0: P21.17 setting 1: PROFIBUS/CANopen setting Bit10–11: Reserved Bit12: Positioning curve selection (reserved) 0: Straight line 1: S curve		
P21.17	Position digital reference	Set digital positioning position; Actual position= $P21.17 \times P21.11 / P21.12$ 0–65535	0	<input type="radio"/>
P21.18	Positioning speed setting selection	0: Set by P21.19 1: Set by AI1 2: Set by AI2 3: Set by AI3 4: Set by high speed pulse HDIA 5: Set by high speed pulse HDIB	0	<input type="radio"/>
P21.19	Positioning speed digits	0–100.0% max. frequency	20.0%	<input type="radio"/>
P21.20	Acceleration time of positioning	Set the acceleration/deceleration time of positioning process.	3.00s	<input type="radio"/>
P21.21	Deceleration time of positioning	Acceleration time of positioning means the time needed for the inverter to accelerate from 0Hz to	3.00s	<input type="radio"/>

Function code	Name	Description	Default value	Modify
		Max. output frequency (P00.03). Deceleration time of positioning means the time needed for the inverter to decelerate from Max. output frequency (P00.03) to 0hz. Setting range of P21.20: 0.01–300.00s Setting range of P21.21: 0.01–300.00s		
P21.22	Hold time of positioning arrival	Set the hold time of waiting when target positioning position is reached. Setting range: 0.000–60.000s	0.100s	<input type="radio"/>
P21.23	Home search speed	0.00–50.00Hz	2.00Hz	<input type="radio"/>
P21.24	Home position offset	0–65535	0	<input type="radio"/>
P21.25	Hold time of positioning completion signal	The hold time of positioning completion signal, this parameter is also valid for positioning completion signal of spindle orientation. Setting range: 0.000–60.000s	0.200s	<input type="radio"/>
P21.26	Pulse superposition value	P21.26: -9999–32767 P21.27: 0–3000.0pulse/ms This function is enabled in the pulse speed reference (P00.06=12) or pulse position mode (P21.00=1):	0	<input type="radio"/>
P21.27	Pulse superposition rate	(P21.00=1):	8.0 pulse/ms	<input type="radio"/>
P21.28	Acceleration/deceleration time after disabling pulse	1. Input terminal function #68 (enable pulse superposition) When the rising edge of the terminal is detected, the pulse setting is increased to the value of P21.26, and the pulse reference channel is compensated by the pulse superposition rate set in P21.27. 2. Input terminal function #67 (progressive increase of pulses) When this terminal is enabled, the pulse reference channel is compensated by the pulse superposition rate set in P21.27. Note: Terminal filtering set in P05.09 may slightly affect the actual superposition. Example: P21.27 = 1.0/ms P05.05 = 67	5.0s	<input type="radio"/>

Function code	Name	Description	Default value	Modify
		<p>If the input signal of terminal S5 is 0.5s, the actual number of superposed pulses is 500.</p> <p>3. Input terminal function #69 (progressive decrease of pulses)</p> <p>The sequence of this function is the same as those described above. The difference lies in that this terminal indicates that negative pulses are superposed.</p> <p>Note: All the pulses described here are superposed on the pulse reference channel (A2, B2). Pulse filtering, electronic gear, and other functions are valid for superposed pulses.</p> <p>4. Output terminal function #28 (pulse superposing)</p> <p>When pulses are superposed, the output terminal operates. After pulses are superposed, the terminal does not operate.</p>		
P21.29	Speed feedforward filter time constant (pulse string speed mode)	It is the filter time constant detected by pulse string when the speed reference source is set to pulse string (P0.06=12 or P0.07=12). Setting range: 0–3200.0ms	10.0ms	<input type="radio"/>
P21.30	Numerator of the 2 nd command ratio	1–65535	1000	<input type="radio"/>
P21.31	Pulse reference speed measuring method	0–2 0: Main control board 1: PG card 2: Hybrid	0	<input type="radio"/>
P21.32	Pulse reference feedforward source	0x0–0x1	0x0	<input checked="" type="radio"/>
P21.33	Set value of clearing encoder count	0–65535	0	<input checked="" type="radio"/>

P22 group Spindle positioning

Function code	Name	Description	Default value	Modify
P22.00	Spindle positioning mode selection	Range: 0x0000–0xFFFF Bit0: Enable spindle positioning	0x0000	<input type="radio"/>

Function code	Name	Description	Default value	Modify
		0: Disable 1: Enable Bit1: Select spindle positioning reference point 0: Z pulse input 1: S2/S3/S4 terminal input Bit2: Search for reference point 0: Search the reference point only once 1: Search the reference point every time Bit3: Enable reference point calibration 0: Disable 1: Enable Bit4: Positioning mode selection 1 0: Set direction positioning 1: Near-by direction positioning Bit5: Positioning mode selection 2 0: Forward positioning 1: Reverse positioning Bit6: Zeroing command selection 0: Electric level mode 1: Pulse mode Bit7: Reference point calibration mode 0: Calibrate at the first time 1: Calibrate in real time Bit8: Action selection after zeroing signal cancellation (electric level type) 0: Switch to speed mode 1: Position lock mode Bit9: Positioning completion signal selection 0: Electric level signal 1: Pulse signal Bit10: Z pulse signal source 0: Motor 1: Spindle Bit11–15: Reserved		
P22.01	Speed of spindle orientation	During spindle orientation, the speed of the position point of orientation will be searched, and then it will switch over to position control orientation. Setting range: 0.00–100.00Hz	10.00Hz	○

Function code	Name	Description	Default value	Modify
P22.02	Deceleration time of spindle orientation	Deceleration time of spindle orientation. Spindle orientation deceleration time means the time needed for the inverter to decelerate from Max. output frequency (P00.03) to 0Hz. Setting range: 0.0–100.0s	3.0s	<input type="radio"/>
P22.03	Spindle zeroing position 0	Users can select the zeroing positions of four spindles by terminals (function code 46, 47). Setting range: 0–39999	0	<input type="radio"/>
P22.04	Spindle zeroing position 1	Setting range: 0–39999	0	<input type="radio"/>
P22.05	Spindle zeroing position 2	Setting range: 0–39999	0	<input type="radio"/>
P22.06	Spindle zeroing position 3	Setting range: 0–39999	0	<input type="radio"/>
P22.07	Spindle scale-division angle 1	Users can select seven spindle scale-division values by terminals (function code 48, 49 and 50). Setting range: 0.00–359.99	15.00	<input type="radio"/>
P22.08	Spindle scale-division angle 2	Setting range: 0.00–359.99	30.00	<input type="radio"/>
P22.09	Spindle scale-division angle 3	Setting range: 0.00–359.99	45.00	<input type="radio"/>
P22.10	Spindle scale-division angle 4	Setting range: 0.00–359.99	60.00	<input type="radio"/>
P22.11	Spindle scale-division angle 5	Setting range: 0.00–359.99	90.00	<input type="radio"/>
P22.12	Spindle scale-division angle 6	Setting range: 0.00–359.99	120.00	<input type="radio"/>
P22.13	Spindle scale-division angle 7	Setting range: 0.00–359.99	180.00	<input type="radio"/>
P22.14	Spindle drive ratio	This function code sets the reduction ratio of the spindle and the mounting shaft of the encoder. Setting range: 0.000–30.000	1.000	<input type="radio"/>

Function code	Name	Description	Default value	Modify
P22.15	Zero-point communication setting of spindle	P22.15 sets spindle zero-point offset, if the selected spindle zero point is P22.03, the final spindle zero point will be the sum of P22.03 and P22.15. Setting range: 0–39999	0	<input type="radio"/>
P22.16	Reserved			
P22.17	Reserved			
P22.18	Rigid tapping selection	Ones: Enable/disable 0: Disable 1: Enable Tens: Analog port selection 0: Invalid 1: AI1 2: AI2 3: AI3	0x00	<input checked="" type="radio"/>
P22.19	Analog filter time of rigid tapping	0.0ms–1000.0ms	1.0ms	<input type="radio"/>
P22.20	Max. frequency of rigid tapping	0.00–400.00Hz	50.00Hz	<input type="radio"/>
P22.21	Corresponding frequency of analog zero drift of rigid tapping	0.00–10.00Hz	0.00Hz	<input type="radio"/>
P22.22–P22.24	Reserved			

P23 group Vector control of motor 2

Function code	Name	Description	Default value	Modify
P23.00	Speed loop proportional gain 1	P23.00–P23.05 fit for vector control mode only. Below switch-over frequency 1 (P23.02), the speed loop PI parameters are P23.00 and P23.01. Above switch-over frequency 2 (P23.05), the speed loop PI parameters are P23.03 and P23.04; in between them, the PI parameters are obtained by linear variation between two groups of parameters, as shown in	20.0	<input type="radio"/>
P23.01	Speed loop integral time 1		0.200s	<input type="radio"/>
P23.02	Switch over low point frequency		5.00Hz	<input type="radio"/>
P23.03	Speed loop proportional gain 2		20.0	<input type="radio"/>

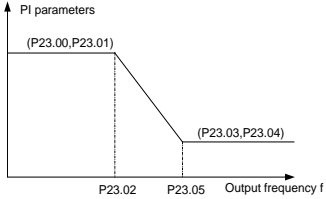
Function code	Name	Description	Default value	Modify
P23.04	Speed loop integral time 2	the figure below. 	0.200s	<input type="radio"/>
P23.05	Switch over high point frequency	<p>The speed loop dynamic response characteristics of vector control can be adjusted by setting the proportional coefficient and integral time of speed regulator. Increase proportional gain or decrease integral time can accelerate dynamic response of speed loop, however, if the proportional gain is too large or integral time is too small, system oscillation and large overshoot may occur; if proportional gain is too small, stable oscillation or speed offset may occur.</p> <p>Speed loop PI parameter is closely related to the system inertia, users should make adjustment according to different load characteristics based on the default PI parameter to fulfill different needs.</p> <p>Setting range of P23.00: 0.0–200.0 Setting range of P23.01: 0.000–10.000s Setting range of P23.02: 0.00Hz–P23.05 Setting range of P23.03: 0.0–200.0 Setting range of P23.04: 0.000–10.000s Setting range of P23.05: P23.02–P00.03 (Max. output frequency)</p>	10.00Hz	<input type="radio"/>
P23.06	Speed loop output filter	0–8 (corresponds to 0–2 ⁸ /10ms)	0	<input type="radio"/>
P23.07	Slip compensation coefficient of vector control (motoring)	Slip compensation coefficient is used to adjust the slip frequency of vector control to improve system speed control precision. Users can effectively control the static error of speed by adjusting this parameter properly.	100%	<input type="radio"/>
P23.08	Slip compensation coefficient of vector control (generating)	Setting range: 50–200%	100%	<input type="radio"/>

Function code	Name	Description	Default value	Modify
P23.09	Current loop proportional coefficient P	Note: 1. These two parameters are used to adjust PI parameters of current loop; it affects dynamic response speed and control precision of the system directly. The default value needs no adjustment under common conditions; 2. Fit for SVC mode 0 (P00.00=0) and FVC mode (P00.00=3); 3. The value of this function code will be updated automatically after parameter autotuning of synchronous motor is done. Setting range: 0–65535	1000	<input type="radio"/>
P23.10	Current loop integral coefficient I		1000	<input type="radio"/>
P23.11	Speed loop differential gain	0.00–10.00s	0.00s	<input type="radio"/>
P23.12	Proportional coefficient of high-frequency current loop	Under FVC mode (P00.00=3), below current loop high-frequency switch-over threshold (P23.14), current loop PI parameters are P23.09 and P23.10; above current loop high-frequency switch-over threshold, current loop PI parameters are P23.12 and P23.13. Setting range of P23.12: 0–20000 Setting range of P23.13: 0–20000 Setting range of P23.14: 0.0–100.0% (relative to max. frequency)	1000	<input type="radio"/>
P23.13	Integral coefficient of high-frequency current loop		1000	<input type="radio"/>
P23.14	High-frequency switch-over threshold of current loop		100.0%	<input type="radio"/>
P23.15–P23.19	Reserved			

P24 group Encoder of motor 2

Function code	Name	Description	Default value	Modify
P24.00	Encoder type display	0: Incremental encoder 1: Resolver-type encoder 2: Sin/Cos encoder 3: Endat absolute encoder	0	<input checked="" type="radio"/>
P24.01	Encoder pulse number	Number of pulses generated when the encoder revolves for one circle. Setting range: 0–60000	1024	<input type="radio"/>

Function code	Name	Description	Default value	Modify
P24.02	Encoder direction	Setting range: 0x000–0x111 Ones: AB direction 0: Forward 1: Reverse Tens: Z pulse direction (reserved) 0: Forward 1: Reverse Hundreds: CD/UVW pole signal direction 0: Forward 1: Reverse	0x000	☉
P24.03	Detection time of encoder offline fault	The detection time of encoder offline fault. Setting range: 0.0–10.0s	2.0s	○
P24.04	Detection time of encoder reversal fault	Detection time of encoder reversal fault. Setting range: 0.0–100.0s	0.8s	○
P24.05	Filter times of encoder detection	Setting range: 0x00–0x99 Ones: Low-speed filter times, corresponds to $2^{(0-9)} \times 125\mu\text{s}$. Tens: High-speed filter times; corresponds to $2^{(0-9)} \times 125\mu\text{s}$.	0x33	○
P24.06	Speed ratio between encoder mounting shaft and motor	Users need to set this parameter when the encoder is not installed on the motor shaft and the drive ratio is not 1. Setting range: 0.001–65.535	1.000	○
P24.07	Control parameters of synchronous motor	Range: 0x0000–0xFFFF Bit0: Enable Z pulse calibration Bit1: Enable encoder angle calibration Bit2: Enable SVC speed measurement Bit3: Reserved Bit4: Reserved Bit5: Reserved Bit6: Enable CD signal calibration Bit7: Reserved Bit8: Do not detect encoder fault during autotuning Bit9: Enable Z pulse detection optimization Bit10: Enable initial Z pulse calibration optimization Bit12: Clear Z pulse arrival signal after stop	0x0003	○

Function code	Name	Description	Default value	Modify
P24.08	Enable Z pulse offline detection	0x00–0x11 Ones: Z pulse Reserved Tens: UVW pulse 0: Do not detect 1: Enable	0x10	<input type="radio"/>
P24.09	Initial angle of Z pulse	Relative electric angle of encoder Z pulse and motor pole position. Setting range: 0.00–359.99	0.00	<input type="radio"/>
P24.10	Initial angle of the pole	Relative electric angle of encoder position and motor pole position. Setting range: 0.00–359.99	0.00	<input type="radio"/>
P24.11	Autotuning of initial angle of pole	0–3 1: Rotary autotuning (DC brake) 2: Static autotuning (suitable for resolver-type encoder, sin/cos with CD signal feedback) 3: Rotary autotuning (initial angle identification)	0	<input checked="" type="radio"/>
P24.12	Speed measurement optimization selection	0: No optimization 1: Optimization mode 1 2: Optimization mode 2	1	<input checked="" type="radio"/>
P24.13	CD signal zero offset gain	0–65535	0	<input type="radio"/>
P24.14	Encoder type selection	Ones: Incremental encoder 0: without UVW 1: with UVW Tens: Sin/Cos encoder 0: without CD signal 1: with CD signal	0x00	<input checked="" type="radio"/>
P24.15	Speed measurement mode	0: PG card 1: local; realized by HDIA and HDIB; supports incremental 24V encoder only	0	<input checked="" type="radio"/>
P24.16	Frequency-division coefficient	0–255 When this parameter is set to 0 or 1, frequency division of 1:1 is implemented.	0	<input type="radio"/>
P24.17	Pulse filter processing	0x0000–0xFFFF Bit0: Enable/disable encoder input filter 0: No filter 1: Filter	0x0033	<input type="radio"/>

Function code	Name	Description	Default value	Modify
		Bit1: Encoder signal filter mode (set Bit0 or Bit2 to 1) 0: Self-adaptive filter 1: Use P20.18 filter parameters Bit2: Enable/disable encoder frequency-division output filter 0: No filter 1: Filter Bit3: Reserved Bit4: Enable/disable pulse reference filter 0: No filter 1: Filter Bit5: Pulse reference filter mode (valid when Bit4 is set to 1) 0: Self-adaptive filter 1: Use P24.19 filter parameters Bit6: Frequency-divided output source setting (valid only for incremental encoders) 0: Encoder signals 1: Pulse reference signals Bits7–15: Reserved		
P24.18	Encoder pulse filter width	0–63 The filtering time is $P24.18 \times 0.25 \mu s$. The value 0 or 1 indicates $0.25 \mu s$.	2	<input type="radio"/>
P24.19	Pulse reference filter width	0–63 The filtering time is $P24.19 \times 0.25 \mu s$. The value 0 or 1 indicates $0.25 \mu s$.	2	<input type="radio"/>
P24.20	Pulse number of pulse reference	0–65535	1024	<input checked="" type="radio"/>
P24.21	Enable angle compensation of synchronous motor	0–1	1	<input type="radio"/>
P24.22	Switch-over frequency threshold of speed measurement mode	0–630.00Hz	1.00Hz	<input type="radio"/>

Function code	Name	Description	Default value	Modify
P24.23	Synchronous motor angle compensation coefficient	-200.0→+200.0%	100.0%	<input type="radio"/>
P24.24	Number of pole pairs in initial magnetic pole angle autotuning	1–128	2	<input type="radio"/>

P25 group Extension I/O card input functions

Function code	Name	Description	Default value	Modify
P25.00	HDI3 input type selection	0: HDI3 is high-speed pulse input 1: HDI3 is digital input	0	<input checked="" type="radio"/>
P25.01	S5 terminal function	Same as the P05 group	0	<input checked="" type="radio"/>
P25.02	S6 terminal function		0	<input checked="" type="radio"/>
P25.03	S7 terminal function		0	<input checked="" type="radio"/>
P25.04	S8 terminal function		0	<input checked="" type="radio"/>
P25.05	S9 terminal function		0	<input checked="" type="radio"/>
P25.06	S10 terminal function		0	<input checked="" type="radio"/>
P25.07	HDI3 terminal function		0	<input checked="" type="radio"/>
P25.08	Input terminal polarity of expansion card		0x00–0x7F	0x00
P25.09	Virtual terminal setting of expansion card	0x000–0x7F (0: disable, 1: enable) BIT0: S5 virtual terminal BIT1: S6 virtual terminal BIT2: S7 virtual terminal BIT3: S8 virtual terminal BIT4: S9 virtual terminal BIT5: S10 virtual terminal BIT6: HDI3 virtual terminal	0x00	<input checked="" type="radio"/>

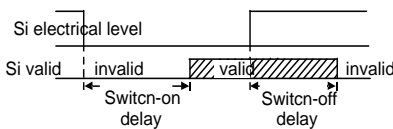
Function code	Name	Description	Default value	Modify	
P25.10	HDI3 terminal switch-on delay	<p>These function codes define corresponding delay of the programmable input terminals during level variation from switch-on to switch-off .</p>  <p>Si electrical level</p> <p>Si valid invalid valid invalid</p> <p>Switch-on delay Switch-off delay</p>	0.000s	<input type="radio"/>	
P25.11	HDI3 terminal switch-off delay		0.000s	<input type="radio"/>	
P25.12	S5 terminal switch-on delay		0.000s	<input type="radio"/>	
P25.13	S5 switch-off delay		0.000s	<input type="radio"/>	
P25.14	S6 terminal switch-on delay		0.000s	<input type="radio"/>	
P25.15	S6 switch-off delay		0.000s	<input type="radio"/>	
P25.16	S7 terminal switch-on delay		0.000s	<input type="radio"/>	
P25.17	S7 switch-off delay		0.000s	<input type="radio"/>	
P25.18	S8 terminal switch-on delay		0.000s	<input type="radio"/>	
P25.19	S8 switch-off delay		Setting range: 0.000–50.000s	0.000s	<input type="radio"/>
P25.20	S9 terminal switch-on delay		0.000s	<input type="radio"/>	
P25.21	S9 switch-off delay		0.000s	<input type="radio"/>	
P25.22	S10 terminal switch-on delay		0.000s	<input type="radio"/>	
P25.23	S10 switch-off delay		0.000s	<input type="radio"/>	
P25.24	Lower limit value of AI3	<p>These function codes define the relation between analog input voltage and corresponding set value of analog input. When the analog input voltage exceeds the range of max./min. input, the max. input or min. input will be adopted during calculation.</p> <p>When analog input is current input, 0–20mA current corresponds to 0–10V voltage. In different application cases, 100% of the analog setting corresponds to different nominal values.</p> <p>The figure below illustrates several settings.</p>	0.00V	<input type="radio"/>	
P25.25	Corresponding setting of lower limit of AI3		0.0%	<input type="radio"/>	
P25.26	Upper limit value of AI3		10.00V	<input type="radio"/>	
P25.27	Corresponding setting of upper limit of AI3		100.0%	<input type="radio"/>	
P25.28	Input filter time of AI3		0.030s	<input type="radio"/>	
P25.29	Lower limit value of AI4		0.00V	<input type="radio"/>	

Function code	Name	Description	Default value	Modify
P25.30	Corresponding setting of lower limit of AI4		0.0%	<input type="radio"/>
P25.31	Upper limit value of AI4		10.00V	<input type="radio"/>
P25.32	Corresponding setting of upper limit of AI4		100.0%	<input type="radio"/>
P25.33	Input filter time of AI4		<p>Input filter time: Adjust the sensitivity of analog input, increase this value properly can enhance the anti-interference capacity of analog variables; however, it will also degrade the sensitivity of analog input.</p> <p>Note: AI3 and AI4 can support 0–10V/0–20mA input, when AI3 and AI4 select 0–20mA input, the corresponding voltage of 20mA is 10V;</p> <p>Setting range of P25.24: 0.00V–P25.26 Setting range of P25.25: -100.0%–100.0% Setting range of P25.26: P25.24–10.00V Setting range of P25.27: -100.0%–100.0% Setting range of P25.28: 0.000s–10.000s Setting range of P25.29: 0.00V–P25.31 Setting range of P25.30: -100.0%–100.0% Setting range of P25.31: P25.29–10.00V Setting range of P25.32: -100.0%–100.0% Setting range of P25.33: 0.000s–10.000s</p>	0.030s
P25.34	HDI3 high-speed pulse input function	0: Set input via frequency 1: Count	0	<input checked="" type="radio"/>
P25.35	Lower limit frequency of HDI3	0.000 KHz – P25.37	0.000 KHz	<input type="radio"/>
P25.36	Corresponding setting of lower limit frequency of HDI3	-100.0%–100.0%	0.0%	<input type="radio"/>
P25.37	Upper limit frequency of HDI3	P25.35 –50.000KHz	50.000 KHz	<input type="radio"/>

Function code	Name	Description	Default value	Modify
P25.38	Corresponding setting of upper limit frequency of HDI3	-100.0%–100.0%	100.0%	<input type="radio"/>
P25.39	HDI3 frequency input filter time	0.000s–10.000s	0.030s	<input type="radio"/>
P25.40	AI3 input signal type	Range: 0–1 0: Voltage type 1: Current type	0	<input type="radio"/>
P25.41	AI4 input signal type	Range: 0–1 0: Voltage type 1: Current type	0	<input type="radio"/>
P25.42– P25.45	Reserved			

P26 group Output functions of extension I/O card

Function code	Name	Description	Default value	Modify
P26.00	HDO2 output type	0: Open collector high-speed pulse output 1: Open collector output	0	<input checked="" type="radio"/>
P26.01	HDO2 output selection	The same with P06.01	0	<input type="radio"/>
P26.02	Y2 output selection		0	<input type="radio"/>
P26.03	Y3 output selection		0	<input type="radio"/>
P26.04	Relay RO3 output selection		0	<input type="radio"/>
P26.05	Relay RO4 output selection		0	<input type="radio"/>
P26.06	Relay RO5 output selection		0	<input type="radio"/>
P26.07	Relay RO6 output selection		0	<input type="radio"/>
P26.08	Relay RO7 output selection		0	<input type="radio"/>
P26.09	Relay RO8 output selection		0	<input type="radio"/>
P26.10	Relay RO9 output selection		0	<input type="radio"/>

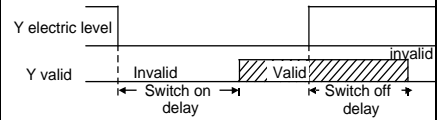
Function code	Name	Description	Default value	Modify
P26.11	Relay RO10 output selection		0	<input type="radio"/>
P26.12	Output terminal polarity of expansion card	0x0000–0x1FFF RO10, RO9...RO3, HDO2, Y3, Y2 in sequence	0x0000	<input type="radio"/>
P26.13	HDO2 switch-on delay	<p>This function code defines the corresponding delay of the level variation from switch-on to switch-off.</p>  <p>Setting range: 0.000–50.000s</p> <p>Note: P26.13 and P26.14 are valid only when P26.00 is set to 1.</p>	0.000s	<input type="radio"/>
P26.14	HDO2 switch-off delay		0.000s	<input type="radio"/>
P26.15	Y2 switch-on delay		0.000s	<input type="radio"/>
P26.16	Y2 switch-off delay		0.000s	<input type="radio"/>
P26.17	Y3 switch-on delay		0.000s	<input type="radio"/>
P26.18	Y3 switch-off delay		0.000s	<input type="radio"/>
P26.19	Relay RO3 switch-on delay		0.000s	<input type="radio"/>
P26.20	Relay RO3 switch-off delay		0.000s	<input type="radio"/>
P26.21	Relay RO4 switch-on delay		0.000s	<input type="radio"/>
P26.22	Relay RO4 switch-off delay		0.000s	<input type="radio"/>
P26.23	Relay RO5 switch-on delay		0.000s	<input type="radio"/>
P26.24	Relay RO5 switch-off delay		0.000s	<input type="radio"/>
P26.25	Relay RO6 switch-on delay		0.000s	<input type="radio"/>
P26.26	Relay RO6 switch-off delay		0.000s	<input type="radio"/>
P26.27	Relay RO7 switch-on delay		0.000s	<input type="radio"/>
P26.28	Relay RO7 switch-off delay		0.000s	<input type="radio"/>
P26.29	Relay RO8 switch-on delay		0.000s	<input type="radio"/>
P26.30	Relay RO8 switch-off delay		0.000s	<input type="radio"/>
P26.31	Relay RO9		0.000s	<input type="radio"/>

Function code	Name	Description	Default value	Modify
	switch-on delay			
P26.32	Relay RO9 switch-off delay		0.000s	<input type="radio"/>
P26.33	Relay RO10 switch-on delay		0.000s	<input type="radio"/>
P26.34	Relay RO10 switch-off delay		0.000s	<input type="radio"/>
P26.35	AO2 output selection	Same as P06.14	0	<input type="radio"/>
P26.36	AO3 output selection		0	<input type="radio"/>
P26.37	Reserved variables		0	<input type="radio"/>
P26.38	Lower limit of AO2 output	<p>Above function codes define the relation between output value and analog output. When the output value exceeds the set max./min. output range, the upper/low limit of output will be adopted during calculation.</p> <p>When analog output is current output, 1mA corresponds to 0.5V voltage. In different applications, 100% of output value corresponds to different analog outputs.</p>	0.0%	<input type="radio"/>
P26.39	Corresponding AO2 output of lower limit		0.00V	<input type="radio"/>
P26.40	Upper limit of AO2 output		100.0%	<input type="radio"/>
P26.41	Corresponding AO2 output of upper limit		10.00V	<input type="radio"/>
P26.42	AO2 output filter time		0.000s	<input type="radio"/>
P26.43	Lower limit of AO3 output		0.0%	<input type="radio"/>
P26.44	Corresponding AO3 output of lower limit		0.00V	<input type="radio"/>
P26.45	Upper limit of AO3 output		100.0%	<input type="radio"/>
P26.46	Corresponding AO3 output of upper limit		10.00V	<input type="radio"/>
P26.47	AO3 output filter time		0.000s	<input type="radio"/>

Function code	Name	Description	Default value	Modify
P26.48– P26.52	Reserved			

P27 group Programmable expansion card functions

Function code	Name	Description	Default value	Modify
P27.00	Enabling programmable card	0–1 This function is reserved.	0	☉
P27.01	I_WrP1	0–65535 Used to write a value to WrP1 of the programmable card.	0	○
P27.02	I_WrP2	0–65535 Used to write a value to WrP2 of the programmable card.	0	○
P27.03	I_WrP3	0–65535 Used to write a value to WrP3 of the programmable card.	0	○
P27.04	I_WrP4	0–65535 Used to write a value to WrP4 of the programmable card.	0	○
P27.05	I_WrP5	0–65535 Used to write a value to WrP5 of the programmable card.	0	○
P27.06	I_WrP6	0–65535 Used to write a value to WrP6 of the programmable card.	0	○
P27.07	I_WrP7	0–65535 Used to write a value to WrP7 of the programmable card.	0	○
P27.08	I_WrP8	0–65535 Used to write a value to WrP8 of the programmable card.	0	○
P27.09	I_WrP9	0–65535 Used to write a value to WrP9 of the programmable card.	0	○
P27.10	I_WrP10	0–65535 Used to write a value to WrP10 of the programmable card.	0	○

Function code	Name	Description	Default value	Modify
P27.11	Programmable card status	0–1 Used to display the status of the programmable card. 0: Stopped 1: Running	0	●
P27.12	C_MoP1	0–65535 Used to monitor/view the MoP1 value of the programmable card.	0	●
P27.13	C_MoP2	0–65535 Used to monitor/view the MoP2 value of the programmable card.	0	●
P27.14	C_MoP3	0–65535 Used to monitor/view the MoP3 value of the programmable card.	0	●
P27.15	C_MoP4	0–65535 Used to monitor/view the MoP4 value of the programmable card.	0	●
P27.16	C_MoP5	0–65535 Used to monitor/view the MoP5 value of the programmable card.	0	●
P27.17	C_MoP6	0–65535 Used to monitor/view the MoP6 value of the programmable card.	0	●
P27.18	C_MoP7	0–65535 Used to monitor/view the MoP7 value of the programmable card.	0	●
P27.19	C_MoP8	0–65535 Used to monitor/view the MoP8 value of the programmable card.	0	●
P27.20	C_MoP9	0–65535 Used to monitor/view the MoP9 value of the programmable card.	0	●
P27.21	C_MoP10	0–65535 Used to monitor/view the MoP10 value of the programmable card.	0	●
P27.22	Digital input terminal status of programmable card	0x00–0x3F Bit5–Bit0 indicate PS6–PS1 respectively.	0x00	●

Function code	Name	Description	Default value	Modify
P27.23	Digital output terminal status of programmable card	0x0–0x3 Bit0 indicates PRO1, and Bit1 indicates PRO2.	0x0	●
P27.24	AI1 of the programmable card	0–10.00V/0.00–20.00mA AI1 value from the programmable card.	0	●
P27.25	AO1 of programmable card	0–10.00V/0.00–20.00mA AO1 value from the programmable card.	0	●
P27.26	Length of data sent by programmable card and PZD communication object	0x00–0x28 Ones place: Quantity of data sent from the programmable card and inverter (that is, quantity of data sent from the programmable card + from inverter sending table 1 + from inverter sending table 2) 0: 0+24+60 1: 12+24+60 2: 24+24+60 3: 36+24+60 4: 48+24+60 5: 60+48+60 6: 72+24+60 7: 84+24+60 8: 96+96+96 Tens place: Card that communicates with the programmable card through PZD (valid only when the ones place of P27.26 is 5) 0: DP card 1: CANopen card 2: PN card Note: P27.26 can be changed at any time, but the change will take effect only after the re-power on.	0x03	○
P27.27	Programmable card save function at power failure	0–1 0: Disable 1: Enable	1	◎
P27.28	Reserved			

Function code	Name	Description	Default value	Modify
P27.29	Reserved			

P28 group Master/slave control functions

Function code	Name	Description	Default value	Modify
P28.00	Master/slave mode selection	0: The master/slave control is invalid 1: This machine is a master 2: This machine is a slave	0	☉
P28.01	Master/slave communication data selection	0: CAN 1: Reserved	0	☉
P28.02	Master/slave control mode	Range: 0x000–0x112 Ones: Master/slave running mode selection 0: Master/slave mode 0 (The master and slave adopt speed control and maintains the power balance by droop control) 1: Master/slave mode 1 (The master and slave must be in the same type of vector control mode. The master is speed control, and the slave will be forced to be in the torque control mode. 2: Master/slave mode 2 Start in the slave first speed mode (master/slave mode 0) and then switch to torque mode at a certain frequency point (master/slave mode 1) Tens: Slave start command source selection 0: Follow the master to start 1: Determined by P00.01 Hundreds: Slave transmitting/master receiving data enable 0: Enable 1: Disable	0x001	☉
P28.03	Slave speed gain	0.0–500.0%	100.0%	○
P28.04	Slave torque gain	0.0–500.0%	100.0%	○
P28.05	Master/slave mode 2 speed mode / torque mode	0.00–10.00Hz	5.00Hz	○

Function code	Name	Description	Default value	Modify
	switching frequency point			
P28.06	Number of slaves	0–15	1	☉
P28.07	Reserved			
P28.08	Reserved			
P28.09	CAN slave torque offset	-100.0–100.0%	0.0%	○
P28.10	Enabling EC PT100/PT1000 to detect temperature	0x00–0x11 Ones place: PT100 temperature detection 0: Disable 1: Enable Tens place: PT1000 temperature detection 0: Disable 1: Enable	0x00	☉
P28.11	EC PT100 detected OH protection threshold	Protection threshold of overheating (OH) detected by the expansion card (EC) with PT100. 0.0–150.0°C	120.0°C	○
P28.12	EC PT100 detected OH pre-alarm threshold	Pre-alarm threshold of OH detected by the EC with PT100. 0.0–150.0°C	100.0°C	○
P28.13	EC PT100 detected temperature calibration upper limit	Calibration upper limit of temperature detected by the EC with PT100. 50.0–150.0°C	120.0°C	○
P28.14	EC PT100 detected temperature calibration lower limit	Calibration lower limit of temperature detected by the EC with PT100. -20.0–50.0°C	10.0°C	○
P28.15	EC PT100 calibration upper limit digital	0–4096	2950	○
P28.16	EC PT100 calibration lower limit digital	0–4096	1270	○
P28.17	EC PT1000 detected OH	0.0–150.0°C	120.0°C	○

Function code	Name	Description	Default value	Modify
	protection threshold			
P28.18	EC PT1000 detected OH pre-alarm threshold	0.0–150.0°C	100.0°C	○
P28.19	PT1000 detected temperature calibration upper limit	50.0–150.0°C	120.0°C	○
P28.20	EC PT1000 detected temperature calibration lower limit	-20.0–50.0°C	10.0°C	○
P28.21	EC PT1000 calibration upper limit digital	0–4096	3100	○
P28.22	EC PT1000 calibration lower limit digital	0–4096	1100	○
P28.23	Detecting for PT100/PT1000 disconnection from EC	0x00–0x11 Ones place: PT100 disconnection detection 0: Disable 1: Enable Tens place: PT1000 disconnection detection 0: Disable 1: Enable	0x00	◎
P28.24	Enabling digital calibration in EC PT100/PT1000 temperature detection	0–4 0: Disable 1: Enable PT100 lower limit digital calibration. 2: Enable PT100 upper limit digital calibration. 3: Enable PT1000 lower limit digital calibration. 4: Enable PT1000 upper limit digital calibration.	0	○
P28.25	Type of sensor for AI/AO card to detect motor temperature	0–4 0: No temperature sensor 1: PT100 2: PT1000 3: KTY84	0	◎

Function code	Name	Description	Default value	Modify
		4: PTC (Measuring resistance only) Note: Temperature is displayed through P19.21. To measure temperature, switch the output of AO1 to current, and connect one end of the temperature resistor to AI1 and AO1, and the other end to GND.		
P28.26	AI/AO detected motor OH protection threshold	0.0–200.0°C Note: When the motor temperature exceeds the threshold, the inverter releases the OT alarm.	110.0°C	<input type="radio"/>
P28.27	AI/AO detected motor OH pre-alarm threshold	0.0–200.0°C Note: When the motor temperature exceeds the value, the DO terminal with function 48 (AI detected motor OH pre-alarm) outputs a valid signal.	90.0°C	<input type="radio"/>
P28.28	Reserved			
P28.29	Reserved			

P90 group Tension control in speed mode

Function code	Name	Description	Default value	Modify
P90.00	Tension control mode	0: Invalid 1: Speed mode 2: Open-loop torque mode 3: Closed-loop torque mode Note: The value 0 indicates tension control is invalid. Select a non-0 value to enable the tension control function.	0	<input checked="" type="radio"/>
P90.01	Winding/unwinding mode	0: Winding 1: Unwinding Note: The motor forward rotation direction is the winding direction. When using the tension control mode, check whether the motor rotation direction is correct in the winding mode; if not, change the rotation direction by swapping two phase wires of the motor. After the rotation direction is corrected, the winding mode can be	0	<input type="radio"/>

Function code	Name	Description	Default value	Modify
		switched to the unwinding mode by setting P90.01 to 1 or changing the winding/unwinding switchover terminals.		
P90.02	Reel mechanical transmission rate	0.01–600.00 =Motor rotation speed/Reel rotation speed=Reel diameter/Motor shaft diameter	1.00	○
P90.03	Max. linear speed	0.0–6000.0 m/min	1000.0 m/min	○
P90.04	Input source of linear speed	0: Keypad 1: AI1 2: AI2 3: AI3 4: High-speed pulse HDI 5: Main traction encoder frequency-division input	0	◎
P90.05	Linear speed set through keypad	0.0–100.0%	20.0%	○
P90.06	Diameter of main traction	0.0–6000.0mm	99.0mm	○
P90.07	Main traction drive ratio	0.000–60.000	1.000	○
P90.08	Linear speed ACC time	0.00–600.00s	0.00s	○
P90.09	Linear speed DEC time	0.00–600.00s	0.00s	○
P90.10	Tension setting	0x00–0x14 Ones place: Tension setting source 0: Keypad 1: AI1 2: AI2 3: AI3 4: High-speed pulse HDI Tens place: Multiplier of max. tension (P90.12) 0: 1 1: 10	0x00	◎
P90.11	Tension set through keypad	0.0–100.0%	10.0%	○
P90.12	Max. tension	When the tens place of P90.10 is 0, the setting range is 0–60000N. When the tens place of P90.10 is 1, the setting range is (0–60000)*10N.	1000N	○

Function code	Name	Description	Default value	Modify
P90.13	Roll diameter calculation mode	0: Not calculated 1: AI1 2: AI2 3: AI3 4: High-speed pulse HDI 5: Linear speed 6: Thickness (of wire) 7: Thickness (of strip)	0	⊙
P90.14	Roll diameter calculation delay time	0.0–100.0s	1.0s	○
P90.15	Min. roll diameter	0.0mm–P90.16	50.0mm	○
P90.16	Max. roll diameter	P90.15–5000.0mm	1000.0mm	○
P90.17	Initial roll diameter 1	P90.15–P90.16 (mm)	100.0mm	○
P90.18	Initial roll diameter 2	P90.15–P90.16 (mm)	100.0mm	○
P90.19	Initial roll diameter 3	P90.15–P90.16 (mm)	100.0mm	○
P90.20	Linear speed roll diameter calculation filter time	0.000–60.000s	2.000s	○
P90.21	Linear speed roll diameter calculation restriction	0x00–0x11 Ones place: 0:No 1: Restrict changes in reverse direction Tens place: 0: No 1: Automatic restriction according to running frequency and material thickness	0x00	○
P90.22	Material thickness	0.001–65.535mm	0.010mm	○
P90.23	Number of coils per layer	1–10000	1	⊙
P90.24	Revolution counting function selection	0–2 0: Digital terminal input 1: PG card input (Applicable to thickness calculation method)	0	⊙

Function code	Name	Description	Default value	Modify
		2: Running frequency (No input automatic revolution counting)		
P90.25	Number of pulses per revolution	1–60	1	☉
P90.26	Roll diameter set value	0.0–100.0%	80.0%	○
P90.27	Roll diameter reset setting	0x0000–0x1111 Ones place: At stop 0: Remain current roll diameter 1: Restore to initial roll diameter Tens place: Power off at running 0: Remain current roll diameter 1: Restore to initial roll diameter Hundreds place: Reach the roll diameter set value 0: Remain current roll diameter 1: Restore to initial roll diameter Thousands place: Terminal reset limitation 0: Reset allowed at running 1: Reset only allowed at stop	0x1000	○
P90.28	Tension PID output reference	0–1 0: Max. value 1: Given value	0	○
P90.29	Tension PID parameter source	0–5 0: First group of P90 1: Roll diameter (max. roll diameter) 2: Main reference frequency (max. Frequency) 3: Running linear speed (max. linear speed) 4: Deviation (Reference 100%) 5: Terminal	0	○
P90.30	Group 1 proportional gain	0.000–30.000	0.030	○
P90.31	Group 1 integral time	0.00–30.00s	5.00s	○
P90.32	Group 1 differential time	0.00–10.00s	0.00s	○
P90.33	Group 2 proportional gain	0.000–30.000	0.030	○
P90.34	Group 2 integral time	0.00–30.00s	5.00s	○

Function code	Name	Description	Default value	Modify
P90.35	Group 2 differential time	0.00–10.00s	0.00s	<input type="radio"/>
P90.36	PID parameter adjustment reference point 1	0.0%–P90.37	10.0%	<input type="radio"/>
P90.37	PID parameter adjustment reference point 2	P90.36–100.0%	50.0%	<input type="radio"/>
P90.38	Min. frequency for roll diameter calculation	0.00–50.00Hz	0.30Hz	<input type="radio"/>
P90.39	Min. linear speed for roll diameter calculation	0.0–100.0%	3.0%	<input type="radio"/>

P91 group Tension control in torque mode

Function code	Name	Description	Default value	Modify
P91.00	Tension control zero speed reference	0–1 0: Max. linear speed 1: Reserved	0	<input checked="" type="radio"/>
P91.01	Tension control zero speed threshold	0.0–50.0%	0.5	<input type="radio"/>
P91.02	Zero speed offset	0.0–50.0%	2.0	<input type="radio"/>
P91.03	Upper-limit frequency source of torque control	0–3 0: P03.14, P03.15 1: Forward rotation limit set by line speed 2: Reverse rotation limit set by line speed 3: Forward and reverse rotations limit set by line speed	3	<input checked="" type="radio"/>
P91.04	Running frequency upper limit offset of tension control	0.0–100.0%	5.0	<input type="radio"/>
P91.05	Differential separation threshold	0.0–100.0%	5.0	<input type="radio"/>
P91.06	PID restricts reverse limit at zero speed	0–1 0: Enable 1: Disable	0	<input checked="" type="radio"/>

Function code	Name	Description	Default value	Modify
P91.07	Torque compensation selection	0x000–0x111 Ones place: Frictional torque compensation 0: No 1: Yes Tens place: Inertia compensation 0: No 1: Yes Hundreds place: Compensation direction 0: In line with torque direction 1: Different from torque direction	0x000	☉
P91.08	System mechanical parameters identification	0–2 0: No operation 1: Enable system mechanical inertia identification 2: Enable mechanical friction torque identification	0	☉
P91.09	Static friction torque compensation coefficient	0.0–100.0%	0.0	○
P91.10	Sliding friction torque compensation coefficient 1	0.0–100.0%	0.0	○
P91.11	Sliding friction torque compensation coefficient 2	0.0–100.0%	0.0	○
P91.12	Sliding friction torque compensation coefficient 3	0.0–100.0%	0.0	○
P91.13	High speed torque compensation coefficient	0.0–100.0%	0.0	○
P91.14	Compensation frequency point of static friction torque	0.0%–P91.15	1.0	○
P91.15	Compensation frequency point of	P91.14–P91.16 (%)	20.0	○

Function code	Name	Description	Default value	Modify
	sliding friction torque 1			
P91.16	Compensation frequency point of sliding friction torque 2	P91.15–P91.17 (%)	50.0	○
P91.17	Compensation frequency point of sliding friction torque 3	P91.16–P91.18 (%)	80.0	○
P91.18	High-speed friction torque compensation frequency point	P91.17–100.0%	100.0	○
P91.19	ACC/DEC frequency source	0–1 0: Linear speed 1: Running frequency	0	◎
P91.20	Material density	0–3000kg/m ³	0	○
P91.21	Reel width	0.000–60.000m	0.000	○
P91.22	ACC inertia compensation coefficient	0.0–100.0%	10.0	○
P91.23	DEC inertia compensation coefficient	0.0–100.0%	10.0	○
P91.24	Tension taper coefficient source	0–4 0: Keypad 1: AI1 2: AI2 3: AI3 4: High-speed pulse HDI	0	◎
P91.25	Tension taper set through keypad	0.0–100.0%	30.0	○
P91.26	Tension taper compensation correction	0.0–5000.0mm	0.0	○
P91.27	Tension taper curve selection	0–1 0: Inverse proportional curve 1: Multi-point curve	0	◎
P91.28	Roll diameter value 1	0.0–5000.0mm	200.0	○

Function code	Name	Description	Default value	Modify
P91.29	Tension taper coefficient for roll diameter value 1	0.0–50.0%	3.0	<input type="radio"/>
P91.30	Roll diameter value 2	0.0–5000.0mm	500.0	<input type="radio"/>
P91.31	Tension taper coefficient for roll diameter value 2	0.0–50.0%	7.0	<input type="radio"/>
P91.32	Tension offset value at zero speed	0.0–300.0%	0.0	<input type="radio"/>
P91.33	Present roll diameter setting	0.0–5000.0mm	0.0	<input checked="" type="radio"/>

P92 group Customized tension control functions

Function code	Name	Description	Default value	Modify
P92.00	Pre-drive speed gain	0.0–100.0%	100.0%	<input type="radio"/>
P92.01	Pre-drive torque limit	0–2 0: Set based on P03.20, P03.21 1: Set based on P93.02 2: Set based on the set tension	2	<input type="radio"/>
P92.02	Pre-drive torque limit setting	0.0–200.0%	100.0%	<input type="radio"/>
P92.03	Zero bit conversion enabling	0–1 0: Disable 1: Enable	0	<input checked="" type="radio"/>
P92.04	Initial zero bit	0.0–100.0%	10.0%	<input type="radio"/>
P92.05	Final zero bit	0.0–100.0%	50.0%	<input type="radio"/>
P92.06	Conversion time from initial zero bit to final zero bit	0.00–60.00s	5.00s	<input type="radio"/>
P92.07	Conversion time from final zero bit to initial zero bit	0.00–60.00s	5.00s	<input type="radio"/>
P92.08	Feeding interrupt detection mode	0–3 0: Not detect	0	<input type="radio"/>

Function code	Name	Description	Default value	Modify
		1: Detect based on digital value 2: Detect based on roll diameter calculation value 3: Detect based on feedback position		
P92.09	Feeding interrupt detection start delay time	0.0–200.0s	20.0s	○
P92.10	Frequency lower limit of feeding interrupt detection	0.00–300.00Hz	10.00Hz	○
P92.11	Error range of feeding interrupt detection	0.1–50.0%	10.0%	○
P92.12	Determination delay time of feeding interrupt detection	0.1–60.0s	1.0s	○
P92.13	Handling mode of feeding interrupt	0x000–0x111 Ones place: Stop mode 0: Decelerate to stop in emergency manner 1: Coast to stop Tens place: Alarm mode 0: Stop in specified mode without reporting alarms 1: Report an alarm and coast to stop Hundreds place: Roll diameter memory function of feeding interrupt 0: Disable 1: Enable	0x000	◎
P92.14	Stop braking frequency	0.00–300.00Hz	1.50Hz	○
P92.15	Stop braking time	0.0–600.0s	0.0s	○

P93 group Tension control status viewing

Function code	Name	Description	Default value	Modify
P93.00	Actual control mode	0–3 0: Invalid tension control	0	●

Function code	Name	Description	Default value	Modify
		1: Close-loop tension speed control 2: Open loop tension torque control 3: Close-loop tension torque control		
P93.01	Actual winding/ unwinding mode	0-1 0: Winding 1: Unwinding	0	●
P93.02	Initial roll diameter	0.0-5000.0mm	0.0mm	●
P93.03	Reset roll diameter	0.0-5000.0mm	0.0mm	●
P93.04	Roll diameter change rate	0.00-655.35 mm/s	0.00 mm/s	●
P93.05	Present roll diameter	0.0-5000.0mm	0.0mm	●
P93.06	Roll diameter for linear speed calculation	0.0-5000.0mm	0.0mm	●
P93.07	Set linear speed	0.0-6000.0 m/min	0.0 m/min	●
P93.08	Present linear speed	0.0-6000.0 m/min	0.0 m/min	●
P93.09	Main reference frequency	0.00-600.00Hz	0.00Hz	●
P93.10	Actual proportional gain	0.00-30.00	0.00	●
P93.11	Actual integral time	0.00-30.00s	0.00s	●
P93.12	Proportional output value	0-65535	0	●
P93.13	Integral output value	0-65535	0	●
P93.14	PID upper limit	-100.0-100.0%	0.0%	●
P93.15	PID lower limit	-100.0-100.0%	0.0%	●
P93.16	PID output frequency	-99.99-99.99Hz	0.00Hz	●
P93.17	Main traction running frequency	-300.0-300.0Hz	0.0Hz	●
P93.18	Set tension	0-30000N	0N	●
P93.19	Tension taper	0.0-100.0%	0.0%	●

Function code	Name	Description	Default value	Modify
	coefficient			
P93.20	Actual tension	0–30000N	0N	●
P93.21	Basic torque reference value	-300.0–300.0%	0.0%	●
P93.22	Friction compensation torque value	-300.0–300.0%	0.0%	●
P93.23	System rotational inertia	0.00–655.35 kg.m ²	0.00 kg.m ²	●
P93.24	Frequency change rate	-99.99–327.67 Hz/s	0.00 Hz/s	●
P93.25	Torque compensation value of system rotational inertia	-300.0–300.0%	0.0%	●
P93.26	Reference value after torque compensation	-300.0–300.0%	0.0%	●
P93.27	PID output torque	-300.0–300.0%	0.0%	●
P93.28	Final output torque	-300.0–300.0%	0.0%	●
P93.29	Measured tension	0–30000N	0 N	●
P93.30	Number of material turns on the reel	-100–32767	0	●
P93.31	Length of material on the reel	0–65535m	0m	●
P93.32	Length increment	0.0–6553.5m	0.0m	●

7 Troubleshooting



Scan this QR code or go to www.galtelectric.com/support/g500/troubleshooting-guide to see video instructions of the troubleshooting guide.

7.1 What this chapter contains

The chapter tells users how to reset faults and check faults history. A complete list of alarms and fault information as well as possible causes and corrective measures are presented in this chapter.



Only well-trained and qualified professionals are allowed to carry out the work described in this chapter. Operations should be carried out according to the instructions presented in chapter 1 "Safety precautions".

7.2 Indications of alarms and faults

The fault is indicated by indicators (refer to the "Keypad operation "). When **TRIP** indicator is on, the alarm or fault code displayed in the keypad indicates the inverter is in exception state. This chapter covers most of the alarms and faults, and their possible causes and corrective measures, if you cannot figure out the alarm or fault causes, contact your distributor or manufacturer's support department.

7.3 Fault reset

Users can reset the inverter via **STOP/RST** key on the keypad, digital inputs, or by cutting off the inverter power. After faults are removed, the motor can be start again.

7.4 Fault history

P07.27–P07.32 record the six latest fault types; P07.33–P07.40, P07.41–P07.48, and P07.49–P07.56 record the running data of the inverter when the latest three faults occurred.

7.5 Inverter faults and solutions

When fault occurred, process the fault as shown below.

1. When inverter fault occurred, confirm whether keypad display is properly functioning. If not, contact your distributor or manufacturer's support department;
2. If keypad works properly, check the function codes in P07 group to confirm the corresponding fault record parameters, and determine the real state when current fault occurred through parameters;

3. Check the table below to see whether corresponding exception states exist based on the corresponding corrective measures;
4. Rule out the faults or ask for help from professionals;
5. After confirming faults are removed, reset the fault and start running.

7.5.1 Details of faults and solutions

Note: The numbers enclosed in square brackets such as [1], [2] and [3] in the Fault type column in the following table indicate the inverter fault type codes read through communication.

Fault code	Fault type	Possible cause	Corrective measures
OUt1	[1] Inverter unit phase-U protection	Acceleration is too fast; IGBT module is damaged;	Increase acceleration time; Replace the power unit;
OUt2	[2] Inverter unit phase-V protection	Misacts caused by interference; drive wires are poorly connected;	Check drive wires; Check whether there is strong interference surrounds the peripheral equipment
OUt3	[3] Inverter unit phase-W protection	To-ground short circuit occurs	
OV1	[7] Over-voltage during acceleration	Exception occurred to input voltage;	Check input power; Check whether load deceleration time is too short; or the motor starts during rotating;
OV2	[8] Over-voltage during deceleration	Large energy feedback;	Install dynamic brake units;
OV3	[9] Over-voltage during constant speed running	Lack of brake units; Dynamic brake is not enabled	Check the setting of related function codes
OC1	[4] Over-current during acceleration	Acceleration is too fast; Grid voltage is too low; Inverter power is too small; Load transient or exception occurred; To-ground short circuit or output phase loss occur; Strong external interference sources; Overvoltage stall protection is not enabled	Increase acceleration /deceleration time;
OC2	[5] Over-current during deceleration		Check input power;
OC3	[6] Over-current during constant speed running		Select the inverter with larger power; Check if the load is short circuited (to-ground short circuit or line-to-line short circuit) or the rotation is not smooth; Check the output wiring; Check if there is strong interference; Check the setting of related function codes.
UV	[10] Bus undervoltage fault	Grid voltage is too low; Overvoltage stall protection is not enabled	Check grid input power; Check the setting of related function codes

Fault code	Fault type	Possible cause	Corrective measures
OL1	[11] Motor overload	Grid voltage is too low; Rated motor current is set improperly; Motor stall or load jumps violently	Check grid voltage; Reset rated motor current; Check the load and adjust torque boost
OL2	[12] Inverter overload	Acceleration is too fast; The motor in rotating is restarted; Grid voltage is too low; Load is too large; Power is too small;	Increase acceleration time; Avoid restart after stop; Check grid voltage; Select the inverter with larger power; Select proper motor
SPI	[13] Input phase loss	Phase loss or violent fluctuation occurred to R, S and T input	Check the input power; Check installation wiring
SPO	[14] Output phase loss	Phase loss occurred to U, V, W output (or the three phases of motor is asymmetrical)	Check the output wiring; Check the motor and cable
OH1	[15] Overheat of rectifier module	Air duct is blocked or fan is damaged;	Ventilate the air duct or replace the fan; Lower the ambient temperature
OH2	[16] Overheat of inverter module	Ambient temperature is too high; Long-time overload running	
EF	[17] External fault	SI external fault input terminal acts	Check external device input
CE	[18] Modbus/Modbus TCP communication fault	Baud rate is set improperly; Communication line fault; Communication address error; Communication suffers from strong interference	Set proper baud rate; Check the wiring of communication interfaces; Set proper communication address; Replace or change the wiring to enhance anti-interference capacity
ItE	[19] Current detection fault	Poor contact of the connector of control board; Hall component is damaged; Exception occurred to amplification circuit	Check the connector and re-plug; Replace the hall component; Replace the main control board
tE	[20] Motor autotuning fault	Motor capacity does not match with the inverter	Change the inverter model, or adopt V/F mode for control;

Fault code	Fault type	Possible cause	Corrective measures
		capacity, this fault may occur easily if the difference between them is exceeds five power classes; Motor parameter is set improperly; The parameters gained from autotuning deviate sharply from the standard parameters; Autotuning timeout	Set proper motor type and nameplate parameters; Empty the motor load and carry out autotuning again; Check motor wiring and parameter setting; Check whether upper limit frequency is larger than 2/3 of the rated frequency
EEP	[21] EEPROM fault	R/W error occurred to the control parameters; EEPROM is damaged	Press STOP/RST to reset; Replace the main control board
PIDE	[22] PID feedback offline fault	PID feedback offline; PID feedback source disappears;	Check PID feedback signal wires; Check PID feedback source
bCE	[23] Braking unit fault	Brake circuit fault or brake tube is damaged; The resistance of external brake resistor is too small	Check the brake unit, replace with new brake tubes; Increase brake resistance
END	[24] Running time is up	The actual running time of the inverter is longer than the set running time	Ask help from the supplier, adjust the set running time
OL3	[25] Electronic overload fault	The inverter releases overload pre-alarm based on the set value	Check the load and overload pre-alarm threshold
PCE	[26] Keypad communication fault	The keypad wire is poorly contacted or disconnected; The keypad wire is too long and suffers strong interference; Circuit fault occurred to the keypad or communication part of the main board	Check the keypad wires to confirm whether fault exists; Check the surroundings to rule out interference source; Replace the hardware and ask for maintenance service
UPE	[27] Parameter upload error	The keypad wire is poorly contacted or disconnected; The keypad wire is too long and suffers strong	Check the surroundings to rule out interference source; Replace the hardware and ask for maintenance service;

Fault code	Fault type	Possible cause	Corrective measures
		interference; Circuit fault occurred to the keypad or communication part of the main board	Replace the hardware and ask for maintenance service
DNE	[28] Parameter download error	The keypad wire is poorly contacted or disconnected; The keypad wire is too long and suffers strong interference; Data storage error occurred to the keypad	Check the surroundings to rule out interference source; Replace the hardware and ask for maintenance service; Re-backup keypad data
ETH1	[32] To-ground short circuit fault 1	Inverter output is short connected to the ground; Current detection circuit is faulty; Actual motor power setting deviates sharply from the inverter power	Check whether motor wiring is proper; Replace the hall component; Replace the main control board; Reset the motor parameters properly
ETH2	[33] To-ground short circuit fault 1	Inverter output is short connected to ground; Current detection circuit is faulty; Actual motor power setting deviates sharply from the inverter power	Check whether motor wiring is proper; Replace the hall component; Replace the main control board; Reset the motor parameters properly
dEu	[34] Speed deviation fault	Load is too heavy, or stall occurred	Check the load to ensure it is proper, increase the detection time; Check whether control parameters are set properly
STo	[35] Maladjustment fault	Control parameters of synchronous motor is set improperly; The parameter gained from autotuning is inaccurate; The inverter is not connected to motor	Check the load to ensure it is proper, Check whether load is proper; Check whether control parameters are set correctly; Increase maladjustment detection time
LL	[36] Electronic underload fault	The inverter performs underload pre-alarm based	Check the load and overload pre-alarm threshold

Fault code	Fault type	Possible cause	Corrective measures
		on the set value	
ENC1O	[37] Encoder offline fault	Encoder line sequence is wrong, or signal wires are poorly connected	Check the encoder wiring
ENC1D	[38] Encoder reversal fault	The encoder speed signal is contrary to the motor running direction	Reset encoder direction
ENC1Z	[39] Encoder Z pulse offline fault	Z signal wires are disconnected	Check the wiring of Z signal
OT	[59] Motor over-temperature fault	Motor over-temperature input terminal is valid; Exception occurred to temperature detection Exception occurred to resistor; Long-time overload running or exception occurred	Check the wiring of motor over-temperature input terminal (terminal function 57); Check whether temperature sensor is proper; Check the motor and perform maintenance on the motor
STO	[40] Safe torque off	Safe torque off function is enabled by external forces	/
STL1	[41] Exception occurred to safe circuit of channel H1	The wiring of STO is improper; Fault occurred to external switch of STO; Hardware fault occurred to safety circuit of channel H1	Check whether terminal wiring of STO is proper and firm enough; Check whether external switch of STO can work properly; Replace the control board
STL2	[42] Exception occurred to channel H2 safe circuit	The wiring of STO is improper; Fault occurred to external switch of STO; Hardware fault occurred to safety circuit of channel H2	Check whether terminal wiring of STO is proper and firm enough; Check whether external switch of STO can work properly; Replace the control board
STL3	[43] Exception occurred to channel H1 and channel H2	Hardware fault occurred to STO circuit	Replace the control board
CrCE	[44] Safety code FLASH CRC check fault	Control board is faulty	Replace the control board
E-Err	[55] Repetitive	The two inserted expansion	Users should not insert two

Fault code	Fault type	Possible cause	Corrective measures
	expansion card type	cards are of the same type	cards with the same type; check the type of expansion card, and remove one card after power down
ENCUV	[56] Encoder UVW loss fault	No electric level variation occurred to UVW signal	Check the wiring of UVW; Encoder is damaged
F1-Er	[60] Failed to identify the expansion card in card slot 1	There is data transmission in interfaces of card slot 1, however, it cannot read the card type	Confirm whether the expansion card inserted can be supported; Stabilize the expansion card interfaces after power down, and confirm whether fault still occurs at next power-on; Check whether the insertion port is damaged, if yes, replace the insertion port after power down
F2-Er	[61] Failed to identify the expansion card in card slot 2	There is data transmission in interfaces of card slot 2, however, it cannot read the card type	Confirm whether the expansion card inserted can be supported; Stabilize the expansion card interfaces after power down, and confirm whether fault still occurs at next power-on; Check whether the insertion port is damaged, if yes, replace the insertion port after power down
F3-Er	[62] Failed to identify the expansion card in card slot 3	There is data transmission in interfaces of card slot 3, however, it cannot read the card type	Confirm whether the expansion card inserted can be supported; Stabilize the expansion card interfaces after power down, and confirm whether fault still occurs at next power-on; Check whether the insertion port is damaged, if yes, replace the insertion port after power down
C1-Er	[63] Communication timeout occurred to the expansion card in card slot 1	There is no data transmission in interfaces of card slot 1	Confirm whether the expansion card inserted can be supported; Stabilize the expansion card interfaces after power down,

Fault code	Fault type	Possible cause	Corrective measures
			and confirm whether fault still occurs at next power-on; Check whether the insertion port is damaged, if yes, replace the insertion port after power down
C2-Er	[64] Communication timeout occurred to the expansion card in card slot 2	There is no data transmission in interfaces of card slot 2	Confirm whether the expansion card inserted can be supported; Stabilize the expansion card interfaces after power down, and confirm whether fault still occurs at next power-on; Check whether the insertion port is damaged, if yes, replace the insertion port after power down
C3-Er	[65] Communication timeout occurred to the expansion card in card slot 3	There is no data transmission in interfaces of card slot 3	Confirm whether the expansion card inserted can be supported; Stabilize the expansion card interfaces after power down, and confirm whether fault still occurs at next power-on; Check whether the insertion port is damaged, if yes, replace the insertion port after power down
E-DP	[29] PROFIBUS card communication timeout fault	There is no data transmission between the communication card and the host computer (or PLC)	Check whether the communication card wiring is loose or dropped
E-NET	[30] Ethernet card communication timeout fault	There is no data transmission between the communication card and the host computer	Check whether the communication card wiring is loose or dropped
E-CAN	[31] CANOpen card communication timeout fault	There is no data transmission between the communication card and the host computer (or PLC)	Check whether the communication card wiring is loose or dropped
E-PN	[57] PROFINET card communication timeout fault	There is no data transmission between the communication card and the host computer (or PLC)	Check whether the communication card wiring is loose or dropped

Fault code	Fault type	Possible cause	Corrective measures
E-CAT	[66] EtherCAT card communication timeout fault	There is no data transmission between the communication card and the host computer (or PLC)	Check whether the communication card wiring is loose or dropped
E-BAC	[67] BACNet card communication timeout fault	There is no data transmission between the communication card and the host computer (or PLC)	Check whether the communication card wiring is loose or dropped
E-DEV	[68] DeviceNET card communication timeout fault	There is no data transmission between the communication card and the host computer (or PLC)	Check whether the communication card wiring is loose or dropped
ESCAN	[58] CAN master/slave communication card communication timeout fault	There is no data transmission between the CAN master and slave communication cards	Check whether the communication card wiring is loose or dropped
S-Err	[69] CAN slave fault in master/slave synchronization	Fault occurred to one of the CAN slave inverters	Detect the CAN slave inverter and analyze the corresponding fault cause of the inverter

7.5.2 Other state

Displayed code	State type	Possible cause	Solution
PoFF	System power failure	The system is powered off or the bus voltage is too low.	Check the grid conditions.

7.6 Analysis on common faults

7.6.1 Motor fails to work

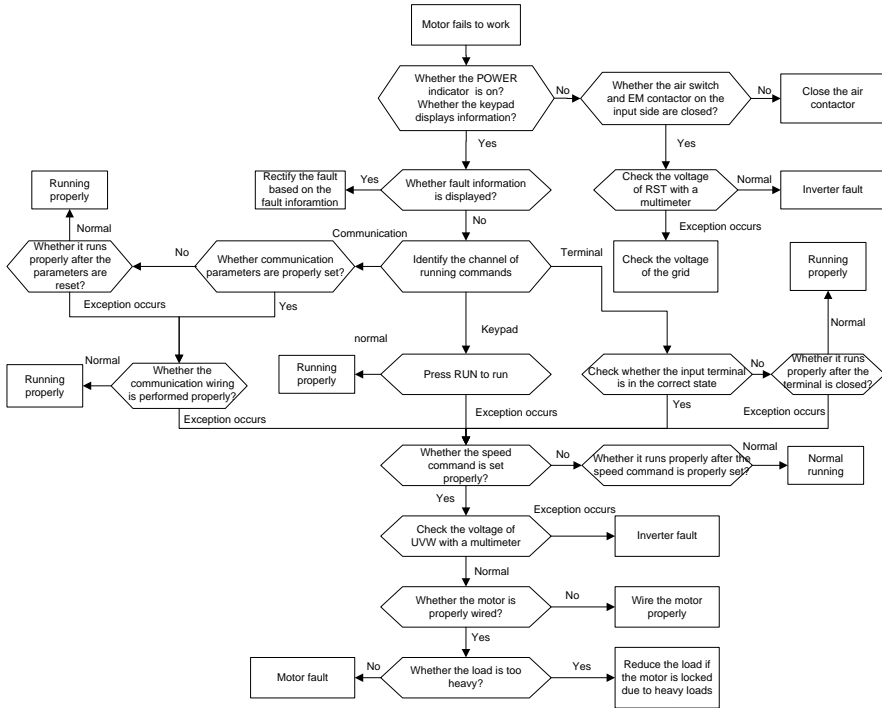

7.6.2 Motor vibrates

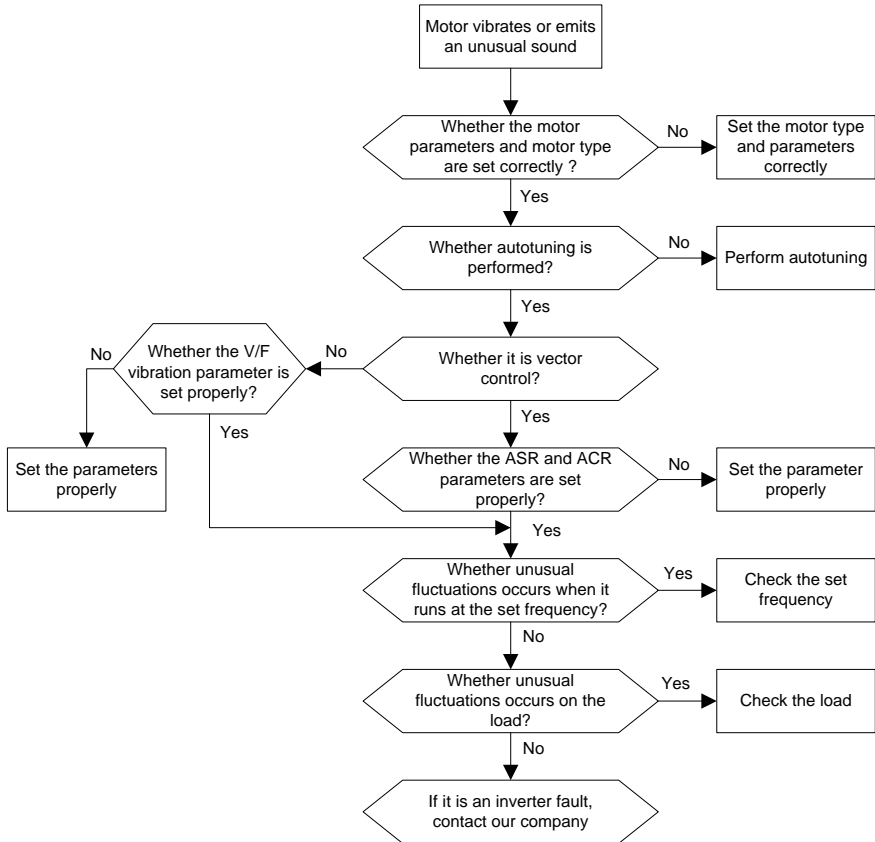

7.6.3 Overvoltage

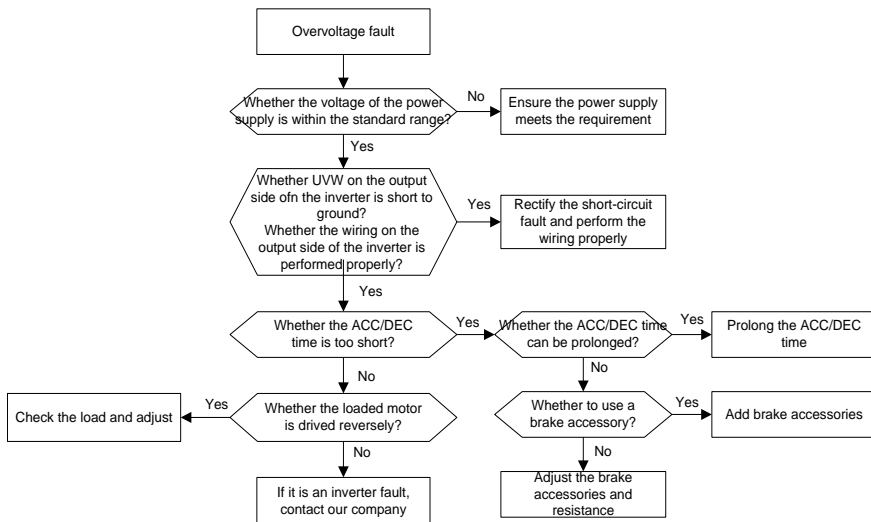

7.6.4 Undervoltage

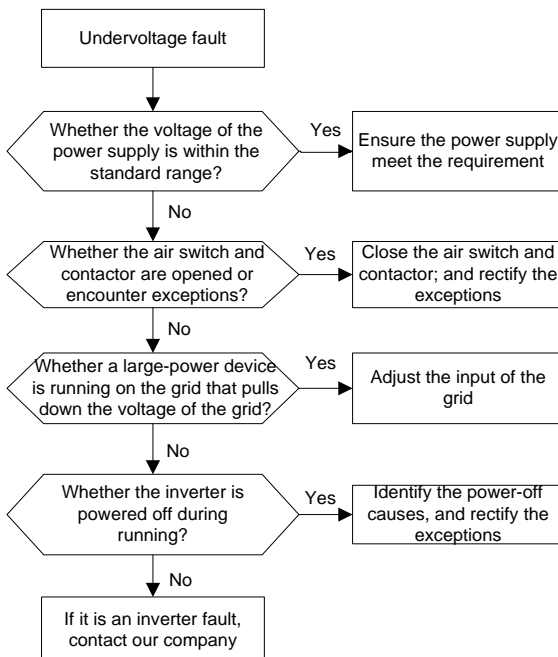

7.6.5 Unusual heating of motor

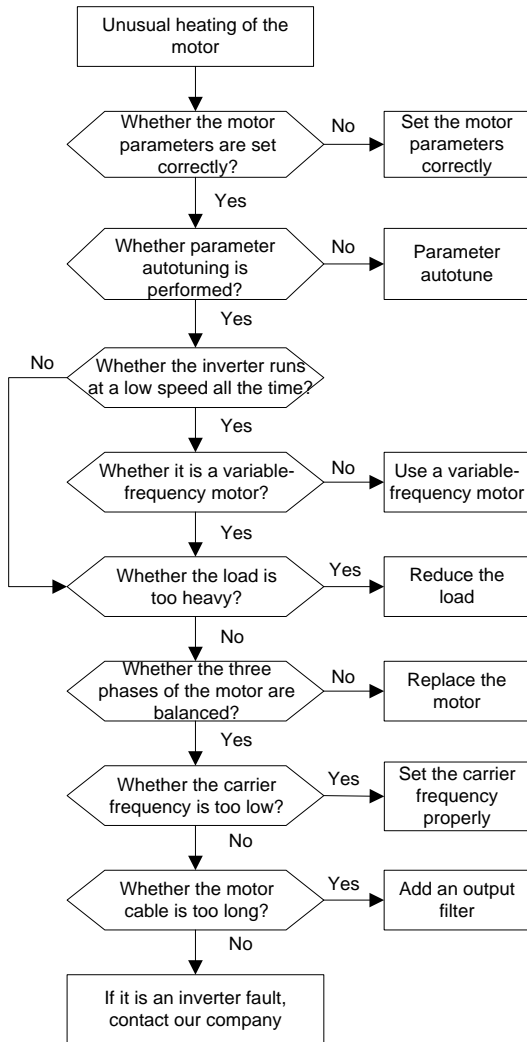

7.6.6 Inverter overheating

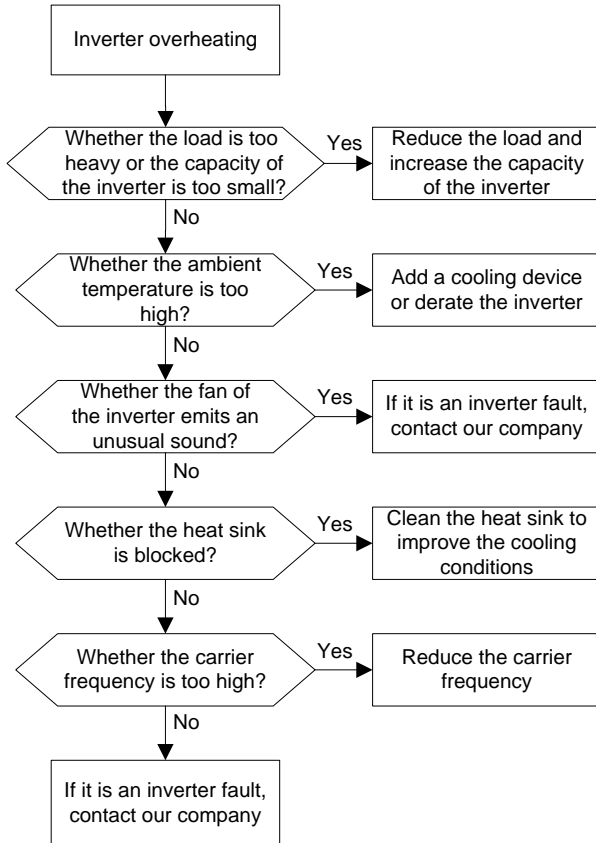

7.6.7 Motor stalls during ACC

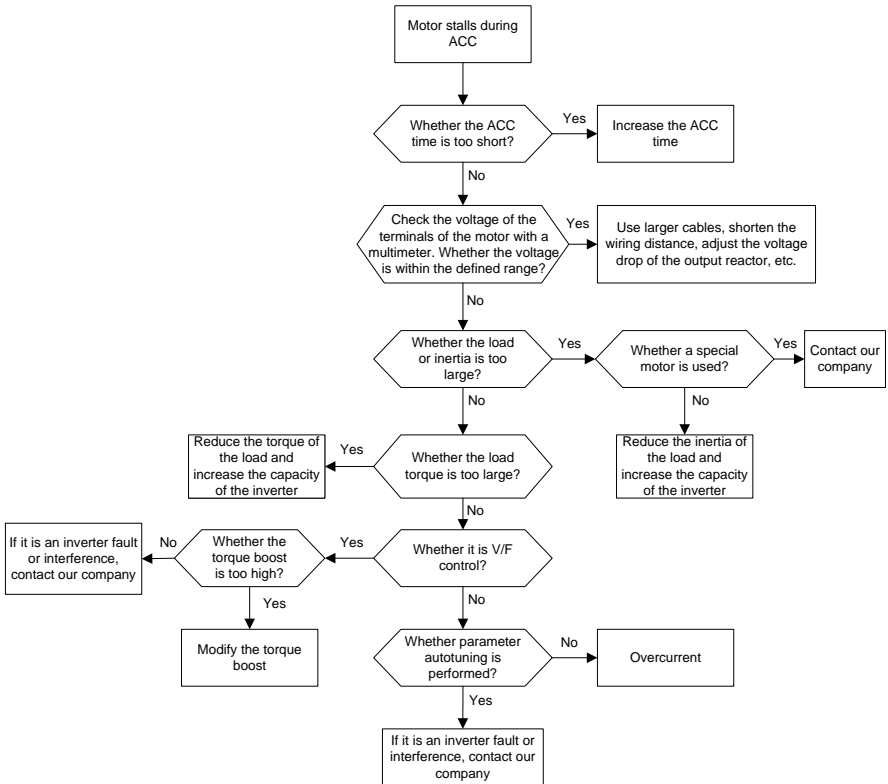

7.6.8 Overcurrent

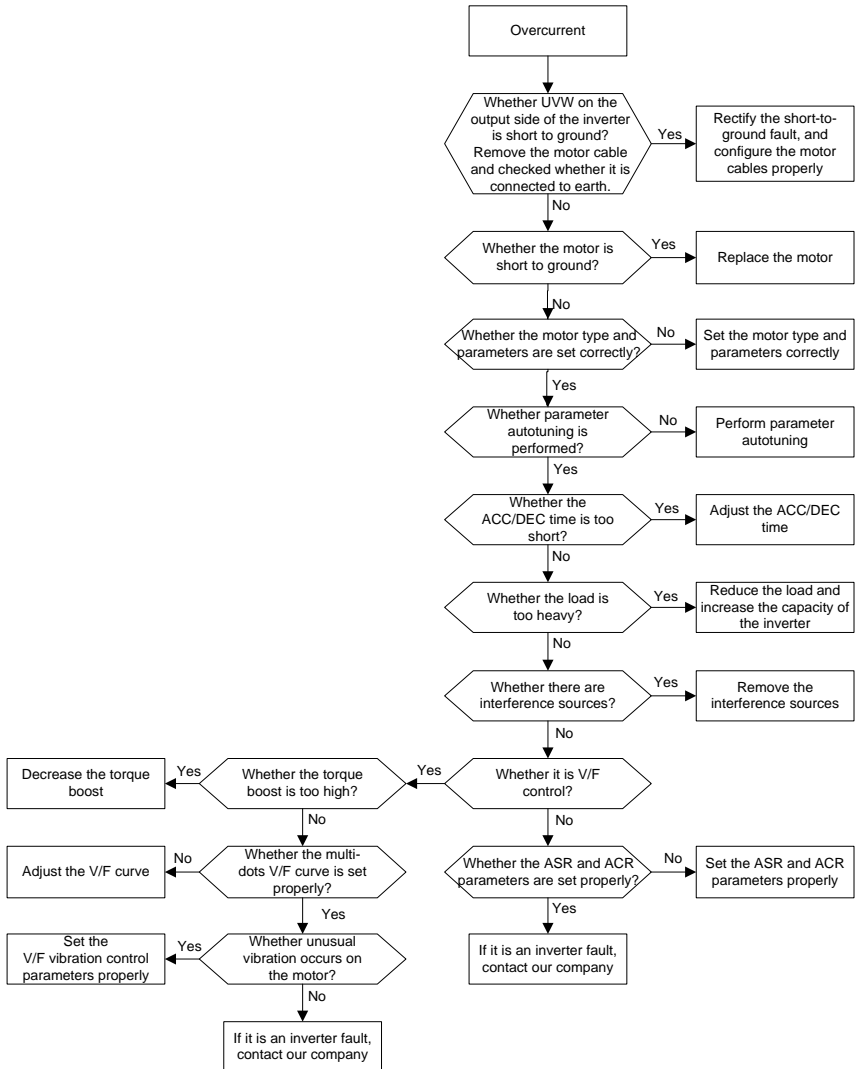

7.7 Countermeasures on common interference

7.7.1 Interference on meter switches and sensors

Interference phenomenon

Pressure, temperature, displacement, and other signals of a sensor are collected and displayed by a human-machine interaction device. The values are incorrectly displayed as follows after the inverter is started:

1. The upper or lower limit is wrongly displayed, for example, 999 or -999.
2. The display of values jumps (usually occurring on pressure transmitters).
3. The display of values is stable, but there is a large deviation, for example, the temperature is dozens of degrees higher than the common temperature (usually occurring on thermocouples).
4. A signal collected by a sensor is not displayed but functions as a drive system running feedback signal. For example, an inverter is expected to decelerate when the upper pressure limit of the compressor is reached, but in actual running, it starts to decelerate before the upper pressure limit is reached.
5. After an inverter is started, the display of all kinds of meters (such as frequency meter and current meter) that are connected to the analog output (AO) terminal of the inverter is severely affected, displaying the values incorrectly.
6. Proximity switches are used in the system. After an inverter is started, the indicator of a proximity switch flickers, and the output level flips.

Solution

1. Check and ensure that the feedback cable of the sensor is 20 cm or farther away from the motor cable.
2. Check and ensure that the ground wire of the motor is connected to the PE terminal of the inverter (if the ground wire of the motor has been connected to the ground block, you need to use a multimeter to measure and ensure that the resistance between the ground block and PE terminal is lower than 1.5 Ω).
3. Try to add a safety capacitor of 0.1 μF to the signal end of the feedback signal terminal of the sensor.
4. Try to add a safety capacitor of 0.1 μF to the power end of the sensor meter (pay attention to the voltage of the power supply and the voltage endurance of the capacitor).
5. For interference on meters connected to the AO terminal of an inverter, if AO uses current signals of 0 to 20 mA, add a capacitor of 0.47 μF between the AO and GND terminals; and if AO uses voltage signals of 0 to 10 V, add a capacitor of 0.1 μF between the AO and GND terminals.

Note:

1. When a decoupling capacitor is required, add it to the terminal of the device connected to the sensor. For example, if a thermocouple is to transmit signals of 0 to 20 mA to a temperature meter,

the capacitor needs to be added on the terminal of the temperature meter.; if an electronic ruler is to transmit signals of 0 to 30 V to a PLC signal terminal, the capacitor needs to be added on the terminal of the PLC.

2. If a large number of meters or sensors are disturbed. It is recommended that you configure an external C2 filter on the input power end of the inverter. For models of filters, see Section D.7.

7.7.2 Interference on communication

Interference phenomenon

The interference described in this section on 485 communication mainly includes communication delay, out of sync, occasional power-off, or complete power-off that occurs after an inverter is started.

If the communication cannot be implemented properly, regardless of whether the inverter is running, the exception is not necessarily caused by interference. You can find out the causes as follows:

1. Check whether the 485 communication bus is disconnected or in poor contact.
2. Check whether the two ends of line A or B are connected reversely.
3. Check whether the communication protocol (such as the baud rate, data bits, and check bit) of the inverter is consistent with that of the upper computer.

If you are sure that communication exceptions are caused by interference, you can resolve the problem through the following measures:

1. Simple inspection.
2. Arrange the communication cables and motor cables in different cable trays.
3. In multi-inverter application scenarios, adopt the chrysanthemum connection mode to connect the communication cables between inverters, which can improve the anti-interference capability.
4. In multi-inverter application scenarios, check and ensure that the driving capacity of the master is sufficient.
5. In the connection of multiple inverters, you need to configure one 120 Ω terminal resistor on each end.

Solution

1. Check and ensure that the ground wire of the motor is connected to the PE terminal of the inverter (if the ground wire of the motor has been connected to the ground block, you need to use a multimeter to measure and ensure that the resistance between the ground block and PE terminal is lower than 1.5 Ω).
2. Do not connect the inverter and motor to the same ground terminal as the upper computer. It is recommended that you connect the inverter and motor to the power ground, and connect the upper computer separately to a ground stud.
3. Try to short the signal reference ground terminal (GND) of the inverter with that of the upper computer controller to ensure that ground potential of the communication chip on the control board of the inverter is consistent with that of the communication chip of the upper computer.

4. Try to short GND of the inverter to its ground terminal (PE).
5. Try to add a safety capacitor of 0.1 μF on the power terminal of the upper computer (PLC, HMI, and touch screen). During this process, pay attention to the voltage of the power supply and the voltage endurance capability of the capacitor. Alternatively, you can use a magnet ring (Fe-based nanocrystalline magnet rings are recommended). Put the power L/N line or +/- line of the upper computer through the magnet ring in the same direction and wind 8 coils around the magnet ring.

7.7.3 Failure to stop and indicator shimmering due to motor cable coupling

Interference phenomenon

1. Failure to stop

In an inverter system where an S terminal is used to control the start and stop, the motor cable and control cable are arranged in the same cable tray. After the system is started properly, the S terminal cannot be used to stop the inverter.

2. Indicator shimmering

After an inverter is started, the relay indicator, power distribution box indicator, PLC indicator, and indication buzzer shimmers, blinks, or emits unusual sounds unexpectedly.

Solution

1. Check and ensure that the exception signal cable is arranged 20 cm or farther away from the motor cable.
2. Add a safety capacitor of 0.1 μF between the digital input terminal (S) and the COM terminal.
3. Connect the digital input terminal (S) that controls the start and stop to other idle digital input terminals in parallel. For example, if S1 is used to control the start and stop and S4 is idle, you can try to connect S1 to S4 in parallel.

Note: If the controller (such as PLC) in the system controls more than 5 inverters at the same time through digital input terminals (S), this scheme is not available.

7.7.4 Leakage current and interference on RCD

Inverters output high-frequency PWM voltage to drive motors. In this process, the distributed capacitance between the internal IGBT of an inverter and the heat sink and that between the stator and rotor of a motor may inevitably cause the inverter to generate high-frequency leakage current to the ground. A residual current operated protective device (RCD) is used to detect the power-frequency leakage current when a grounding fault occurs on a circuit. The application of an inverter may cause misoperation of an RCD.

1. Rules for selecting RCDs

- (1) Inverter systems are special. In these systems, it is required that the rated residual current of common RCDs at all levels is larger than 200 mA, and the inverters are grounded reliably.
- (2) For RCDs, the time limit of an action needs to be longer than that of a next action, and the time difference between two actions need to be longer than 20 ms. For example, 1s, 0.5s, and 0.2s.

- (3) For circuits in inverter systems, electromagnetic RCDs are recommended. Electromagnetic RCDs have strong anti-interference capability, and thus can prevent the impact of high-frequency leakage current.

Electronic RCD	Electromagnetic RCD
Low cost, high sensitivity, small in volume, susceptible to voltage fluctuation of the grid and ambient temperature, weak anti-interference capability	Requiring highly sensitive, accurate, and stable zero-phase sequence current transformer, using permalloy high-permeability materials, complex process, high cost, not susceptible to voltage fluctuation of the power supply and ambient temperature, strong anti- interference capability

2. Solution to RCD misoperation (handling the inverter)

- (1) Try to reduce the carrier frequency to 1.5 kHz (P00.14=1.5).
- (2) Try to modify the modulation mode to "3PH modulation and 2PH modulation" (P08.40=00).

3. Solution to RCD misoperation (handling the system power distribution)

- (1) Check and ensure that the power cable is not soaking in water.
- (2) Check and ensure that the cables are not damaged or spliced.
- (3) Check and ensure that no secondary grounding is performed on the neutral wire.
- (4) Check and ensure that the main power cable terminal is in good contact with the air switch or contactor (all screws are tightened).
- (5) Check 1PH powered devices, and ensure that no earth lines are used as neutral wires by these devices.
- (6) Do not use shielded cables as inverter power cables and motor cables.

7.7.5 Live device chassis

Phenomenon

After an inverter is started, there is sensible voltage on the chassis, and you may feel an electric shock when touching the chassis. The chassis, however, is not live (or the voltage is far lower than the human safety voltage) when the inverter is powered on but not running.

Solution

1. If there is power distribution grounding or ground stud on the site, ground the cabinet chassis of the drive system through the power ground or stud.
2. If there is no grounding on the site, you need to connect the motor chassis to the ground terminal PE of the inverter, and ensure that the jumper at "EMC/J10" on the middle casing of the inverter is shorted.

8 Maintenance and hardware fault diagnosis



Scan this QR code or go to www.galtelectric.com/support/g500/maintenance-guide to see video instructions of the maintenance guide.

8.1 What this chapter contains

This chapter describes how to carry out preventive maintenance on G500 series inverters.

8.2 Periodical inspection

Little maintenance is required when inverters are installed in environments that meet requirements. The following table describes the routine maintenance periods recommended by Galt Electric.

Subject		Item	Method	Criterion
Ambient environment		Check the temperature, and humidity, and whether there is vibration, dust, gas, oil spray, and water droplets in the environment.	Visual inspection, and use instruments for measurement.	The requirements stated in this manual are met.
		Check whether there are foreign matters, such as tools, or dangerous substances placed nearby.	Visual inspection	There are no tools or dangerous substances placed nearby.
Voltage		Check the voltage of the main circuit and control circuit.	Use multimeters or other instruments for measurement.	The requirements stated in this manual are met.
Keypad		Check the display of information.	Visual inspection	The characters are displayed properly.
		Check whether characters are not completely displayed.	Visual inspection	The requirements stated in this manual are met.
Main circuit	Common	Check whether the bolts loose or come off.	Screw them up.	No exception occurs.
		Check whether the machine is deformed, cracked, or damaged, or their color changes due to overheating and aging.	Visual inspection	No exception occurs.

Subject	Item	Method	Criterion
	Check whether there are stains and dust attached.	Visual inspection	No exception occurs. Note: Discoloration of copper bars does not mean that they cannot work properly.
Conductor and wire	Check whether the conductors are deformed or their color change due to overheat.	Visual inspection	No exception occurs.
	Check whether the wire sheaths are cracked or their color changes.	Visual inspection	No exception occurs.
Terminal block	Check whether there is damage.	Visual inspection	No exception occurs.
Filter capacitor	Check whether there is electrolyte leakage, discoloration, cracks, and chassis expansion.	Visual inspection	No exception occurs.
	Check whether the safety valves are released.	Determine the service life based on the maintenance information, or measure them through electrostatic capacity.	No exception occurs.
	Check whether the electrostatic capacity is measured as required.	Use instruments to measure the capacity.	Electrostatic capacity \geq initial value \times 0.85
Resistor	Check whether there is displacement caused due to overheat.	Olfactory and visual inspection	No exception occurs.
	Check whether the resistors are disconnected.	Visual inspection, or remove one end of the connection cable and use a multimeter for measurement.	Resistance range: $\pm 10\%$ (of the standard resistance)

Subject		Item	Method	Criterion
	Transformer and reactor	Check whether there is unusual vibration sounds or smells.	Auditory, olfactory, and visual inspection	No exception occurs.
	Electromagnetic contactor and relay	Check whether there are vibration sounds in the workshop.	Auditory inspection	No exception occurs.
		Check whether the contacts are in good contact.	Visual inspection	No exception occurs.
Control circuit	Control PCB, connector	Check whether the screws and connectors loose.	Screw them up.	No exception occurs.
		Check whether there is unusual smell or discoloration.	Olfactory and visual inspection	No exception occurs.
		Check whether there are cracks, damage, deformation, or rust.	Visual inspection	No exception occurs.
		Check whether there is electrolyte leakage or deformation.	Visual inspection, and determine the service life based on the maintenance information.	No exception occurs.
Cooling system	Cooling fan	Check whether there are unusual sounds or vibration.	Auditory and visual inspection, and turn the fan blades with your hand.	The rotation is smooth.
		Check whether the bolts loose.	Screw them up.	No exception occurs.
		Check whether there is decoloration caused due to overheat.	Visual inspection, and determine the service life based on the maintenance information.	No exception occurs.
	Ventilation duct	Check whether there are foreign matters blocking or attached to the cooling fan, air inlets, or air outlets.	Visual inspection	No exception occurs.

Consult the local service representative for more details on the maintenance. Visit the official website.

8.3 Cooling fan

The service life of the cooling fan of the inverter is more than 25,000 hours. The actual service life of the cooling fan is related to the use of the inverter and the temperature in the ambient environment.

You can view the running duration of the inverter through P07.14 (Accumulated running time).

The increase of the bearing noise indicates a fan fault. If the inverter is applied in a key position, replace the fan once the fan starts to generate unusual noise. Spare parts of fans are available.

Cooling fan replacement

	Read chapter 1 "Safety precautions" carefully and follow the instructions to perform operations. Otherwise, physical injuries or damage to the device may be caused.
---	--

1. Stop the device, disconnect the AC power supply, and wait for a time no shorter than the waiting time designated on the inverter.
2. Open the cable clamp to loosen the fan cable (for inverters of 460 V, 1.5kW/2HP to 30 kW/HP, the middle casing needs to be removed).
3. Remove the fan cable.
4. Remove the fan with a screwdriver.
5. Install a new fan in the inverter in the reverse steps. Assemble the inverter. Ensure that the air direction of the fan is consistent with that of the inverter, as shown in the following figure.

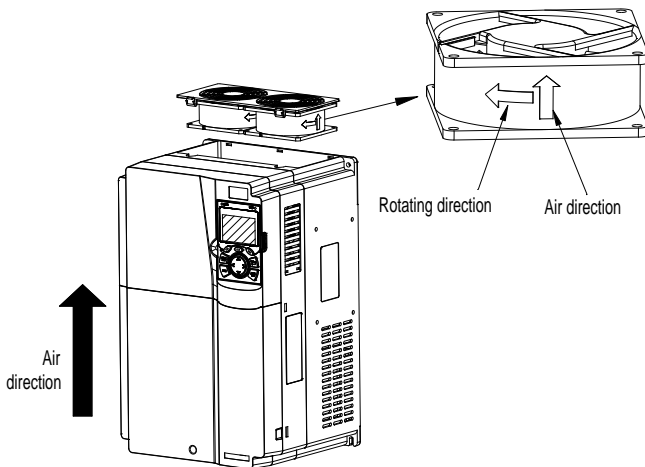

Figure 8-1 Fan maintenance for inverters of 7.5 kW/10HP or higher

6. Power on the inverter.

8.4 Capacitor

8.4.1 Capacitor reforming

If the inverter has been left unused for a long time, you need to follow the instructions to reform the DC bus capacitor before using it. The storage time is calculated from the date the inverter is delivered.

Storage time	Operation principle
Less than 1 year	No charging operation is required.
1 to 2 years	The inverter needs to be powered on for 1 hour before the first running command.
2 to 3 years	Use a voltage controlled power supply to charge the inverter: Charge the inverter at 25% of the rated voltage for 30 minutes, and then charge it at 50% of the rated voltage for 30 minutes, at 75% for another 30 minutes, and finally charge it at 100% of the rated voltage for 30 minutes.
More than 3 years	Use a voltage-controlled power supply to charge the inverter: Charge the inverter at 25% of the rated voltage for 2 hours, and then charge it at 50% of the rated voltage for 2 hours, at 75% for another 2 hours, and finally charge it at 100% of the rated voltage for 2 hours.

The method for using a voltage-controlled power supply to charge the inverter is described as follows: The selection of a voltage-controlled power supply depends on the power supply of the inverter. For inverters with an incoming voltage of 1PH/3PH 230 V AC, you can use a 230 V AC/2 A voltage regulator. Both 1PH and 3PH inverters can be charged with a 1PH voltage-controlled power supply (connect L+ to R, and N to S or T). All the DC bus capacitors share one rectifier, and therefore they are all charged.

For inverters of a high voltage class, ensure that the voltage requirement (for example, 460 V) is met during charging. Capacitor charging requires little current, and therefore you can use a small-capacity power supply (2 A is sufficient).

The method for using a resistor (incandescent lamp) to charge the drive is described as follows:

If you directly connect the drive device to a power supply to charge the DC bus capacitor, it needs to be charged for a minimum of 60 minutes. The charging operation must be performed at a normal indoor temperature without load, and you must connect a resistor in series mode in the 3PH circuit of the power supply.

For a 460 V drive device, use a resistor of 1 k Ω /100W. If the voltage of the power supply is no higher than 460 V, you can also use an incandescent lamp of 100W. If an incandescent lamp is used, it may go off or the light may become very weak.

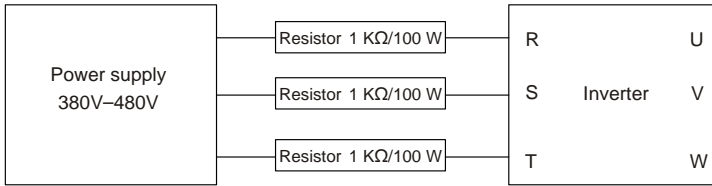

Figure 8-2 Charging circuit example of driving devices of 460 V

8.4.2 Electrolytic capacitor replacement



Read the safety precautions carefully and follow the instructions to perform operations. Otherwise, physical injuries or damage to the device may be caused.

The electrolytic capacitor of an inverter must be replaced if it has been used for more than 35,000 hours. For details about the replacement, contact Galt Electric technical support.

8.5 Power cable



Read the safety precautions carefully and follow the instructions to perform operations. Otherwise, physical injuries or damage to the device may be caused.

1. Stop the inverter, disconnect the power supply, and wait for a time no shorter than the waiting time designated on the inverter.
2. Check the connection of the power cables. Ensure that they are firmly connected.
3. Power on the inverter.

9 Communication protocol

9.1 What this chapter contains

This chapter describes the communication protocol of the G500 series.

G500 series inverters provide RS485 communication interfaces and adopt the master-slave communication based on the international standard Modbus communication protocol. You can implement centralized control (setting commands for controlling the inverter, modifying the running frequency and related function code parameters, and monitoring the working state and fault information of the inverter) through PC/PLC, upper control computer, or other devices to meet specific application requirements.

9.2 Modbus protocol introduction

Modbus is a software protocol, a common language used in electronic controllers. By using this protocol, a controller can communicate with other devices through transmission lines. It is a general industrial standard. With this standard, control devices produced by different manufacturers can be connected to form an industrial network and be monitored in a centralized way.

The Modbus protocol provides two transmission modes, namely American Standard Code for Information Interchange (ASCII) and remote terminal units (RTU). On one Modbus network, all the device transmission modes, baud rates, data bits, check bits, end bits, and other basic parameters must be set consistently.

A Modbus network is a control network with one master and multiple slaves, that is, on one Modbus network, there is only one device serving as the master, and other devices are the slaves. The master can communicate with one slave or broadcast messages to all the slaves. For separate access commands, a slave needs to return a response. For broadcasted information, slaves do not need to return responses.

9.3 Application of Modbus

G500 series inverters use the RTU mode provided by the Modbus protocol, and RS485 interfaces are used.

9.3.1 RS485

RS485 interfaces work in half-duplex mode and transmit data signals in the differential transmission way, which is also referred to as balanced transmission. An RS485 interface uses a twisted pair, where one wire is defined as A (+), and the other B (-). Generally, if the positive electrical level between the transmission drives A and B ranges from +2 V to +6 V, the logic is "1"; and if it ranges from -2 V to -6 V, the logic is "0".

The 485+ terminal on the terminal block of the inverter corresponds to A, and 485- corresponds to B.

The communication baud rate (P14.01) indicates the number of bits transmitted in a second, and the unit is bit/s (bps). A higher baud rate indicates faster transmission and poorer anti-interference capability. When a twisted pair of 0.56 mm (24 AWG) is used, the maximum transmission distance varies according to the baud rate, as described in the following table.

Baud rate (bps)	Max. transmission distance	Baud rate (bps)	Max. transmission distance
2400	1800 m	9600	800 m
4800	1200 m	19200	600 m

When RS485 interfaces are used for long-distance communication, it is recommended that you use shielded cables, and use the shield layer as the ground wires.

When there are fewer devices and the transmission distance is short, the whole network works well without terminal load resistors. The performance, however, degrades as the distance increases. Therefore, it is recommended that you use a 120 Ω terminal resistor when the transmission distance is long.

9.3.1.1 Application to one inverter

Figure 9-1 is the Modbus wiring diagram of one inverter and a PC. Generally, PCs do not provide RS485 interfaces, so you need to convert an RS232 interface or USB port of a PC to an RS485 interface. Connect end A of the RS485 interface to the 485+ port on the terminal block of the inverter, and connect end B to the 485- port. It is recommended that you use shielded twisted pairs. When an RS232-RS485 converter is used, the cable used to connect the RS232 interface of the PC and the converter cannot be longer than 15 m. Use a short cable when possible. It is recommended that you insert the converter directly into the PC. Similarly, when a USB-RS485 converter is used, use a short cable when possible.

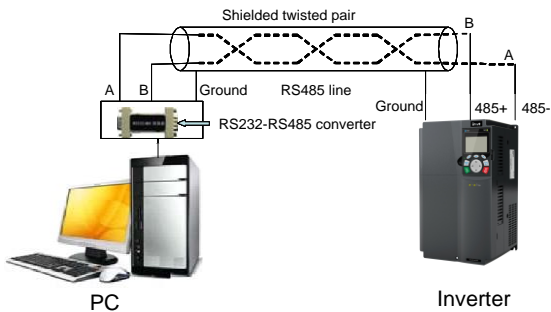

Figure 9-1 Wiring of RS485 applied to one inverter

9.3.1.2 Application to multiple inverters

In practical application to multiple inverters, chrysanthemum connection and star connection are commonly used.

According to the requirements of the RS485 industrial bus standards, all the devices need to be connected in chrysanthemum mode with one 120 Ω terminal resistor on each end, as shown in Figure 9-2. Figure 9-3 is the simplified wiring diagram, and Figure 9-4 is the practical application diagram.

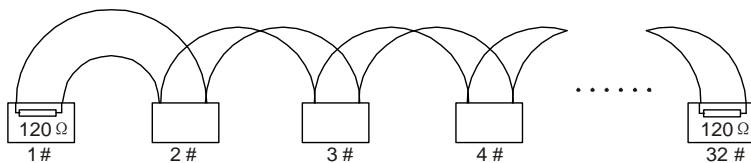

Figure 9-2 On-site chrysanthemum connection diagram

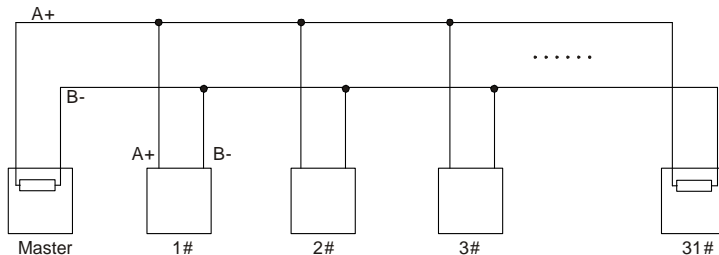

Figure 9-3 Simplified chrysanthemum connection diagram

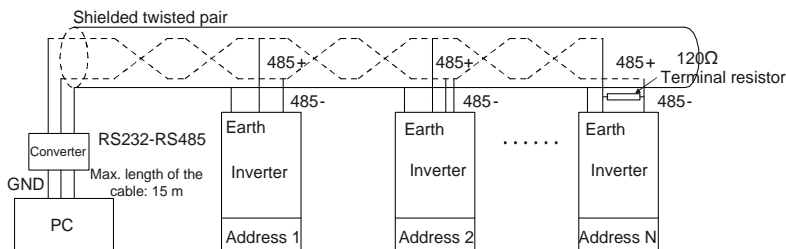

Figure 9-4 Practical application diagram of chrysanthemum connection

Figure 9-5 shows the star connection diagram. When this connection mode is adopted, the two devices that are farthest away from each other on the line must be connected with a terminal resistor (in Figure 9-5, the two devices are devices 1# and 15#).

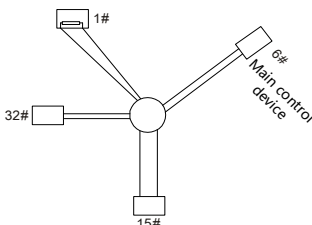

Figure 9-5 Star connection

Use shielded cable, if possible, in multi-device connection. The baud rates, data bit check settings, and other basic parameters of all the devices on the RS485 line must be set consistently, and addresses cannot be repeated.

9.3.2 RTU mode

9.3.2.1 RTU communication frame structure

When a controller is set to use the RTU communication mode on a Modbus network, every byte (8 bits) in the message includes 2 hexadecimal characters (each includes 4 bits). Compared with the ASCII mode, the RTU mode can transmit more data with the same baud rate.

Code system

- 1 start bit
- 7 or 8 data bits; the minimum valid bit is transmitted first. Each frame domain of 8 bits includes 2 hexadecimal characters (0–9, A–F).
- 1 odd/even check bit; this bit is not provided if no check is needed.
- 1 end bit (with check performed), 2 bits (without check)

Error detection domain

- Cyclic redundancy check (CRC)

The following table describes the data format.

11-bit character frame (Bits 0 to 7 are data bits)

Start bit	BIT0	BIT1	BIT2	BIT3	BIT4	BIT5	BIT6	BIT7	Check bit	End bit
-----------	------	------	------	------	------	------	------	------	-----------	---------

10-bit character frame (Bits 0 to 6 are data bits)

Start bit	BIT0	BIT1	BIT2	BIT3	BIT4	BIT5	BIT6	Check bit	End bit
-----------	------	------	------	------	------	------	------	-----------	---------

In a character frame, only the data bits carry information. The start bit, check bit, and end bit are used to facilitate the transmission of the data bits to the destination device. In practical applications, you must set the data bits, parity check bits, and end bits consistently.

In RTU mode, the transmission of a new frame always starts from an idle time (the transmission time of 3.5 bytes). On a network where the transmission rate is calculated based on the baud rate, the transmission time of 3.5 bytes can be easily obtained. After the idle time ends, the data domains are transmitted in the following sequence: slave address, operation command code, data, and CRC check character. Each byte transmitted in each domain includes 2 hexadecimal characters (0–9, A–F). The network devices always monitor the communication bus. After receiving the first domain (address information), each network device identifies the byte. After the last byte is transmitted, a similar transmission interval (the transmission time of 3.5 bytes) is used to indicate that the transmission of the frame ends. Then, the transmission of a new frame starts.

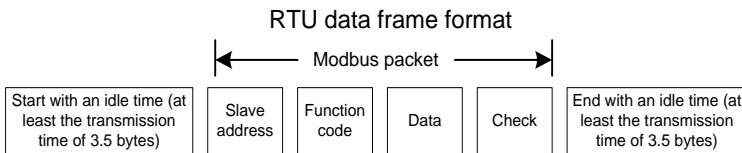

The information of a frame must be transmitted in a continuous data flow. If there is an interval greater

than the transmission time of 1.5 bytes before the transmission of the entire frame is complete, the receiving device deletes the incomplete information, and mistakes the subsequent byte for the address domain of a new frame. Similarly, if the transmission interval between two frames is shorter than the transmission time of 3.5 bytes, the receiving device mistakes it for the data of the last frame. The CRC check value is incorrect due to the disorder of the frames, and thus a communication fault occurs.

The following table describes the standard structure of an RTU frame.

START (frame header)	T1-T2-T3-T4 (transmission time of 3.5 bytes)
ADDR (slave address domain)	Communication address: 0–247 (decimal system) (0 is the broadcast address)
CMD (function domain)	03H: read slave parameters 06H: write slave parameters
DATA (N-1) ... DATA (0) (data domain)	Data of 2×N bytes, main content of the communication as well as the core of data exchanging
CRC CHK (LSBs)	Detection value: CRC (16 bits)
CRC CHK (MSBs)	
END (frame tail)	T1-T2-T3-T4 (transmission time of 3.5 bytes)

9.3.2.2 RTU communication frame error check modes

During the transmission of data, errors may occur due to various factors. Without check, the data receiving device cannot identify data errors and may make a wrong response. The wrong response may cause severe problems. Therefore, the data must be checked.

The check is implemented as follows: The transmitter calculates the to-be-transmitted data based on a specific algorithm to obtain a result, adds the result to the rear of the message, and transmits them together. After receiving the message, the receiver calculates the data based on the same algorithm to obtain a result, and compares the result with that transmitted by the transmitter. If the results are the same, the message is correct. Otherwise, the message is considered wrong.

The error check of a frame includes two parts, namely, bit check on individual bytes (that is, odd/even check using the check bit in the character frame), and whole data check (CRC check).

Bit check on individual bytes (odd/even check)

You can select the bit check mode as required, or you can choose not to perform the check, which will affect the check bit setting of each byte.

Definition of even check: Before the data is transmitted, an even check bit is added to indicate whether the number of "1" in the to-be-transmitted data is odd or even. If it is even, the check bit is set to "0"; and if it is odd, the check bit is set to "1".

Definition of odd check: Before the data is transmitted, an odd check bit is added to indicate whether the number of "1" in the to-be-transmitted data is odd or even. If it is odd, the check bit is set to "0";

and if it is even, the check bit is set to "1".

For example, the data bits to be transmitted are "11001110", including five "1". If the even check is applied, the even check bit is set to "1"; and if the odd check is applied, the odd check bit is set to "0". During the transmission of the data, the odd/even check bit is calculated and placed in the check bit of the frame. The receiving device performs the odd/even check after receiving the data. If it finds that the odd/even parity of the data is inconsistent with the preset information, it determines that a communication error occurs.

CRC check mode

A frame in the RTU format includes an error detection domain based on the CRC calculation. The CRC domain checks all the content of the frame. The CRC domain consists of two bytes, including 16 binary bits. It is calculated by the transmitter and added to the frame. The receiver calculates the CRC of the received frame, and compares the result with the value in the received CRC domain. If the two CRC values are not equal to each other, errors occur in the transmission.

During CRC, 0xFFFF is stored first, and then a process is invoked to process a minimum of 6 contiguous bytes in the frame based on the content in the current register. CRC is valid only for the 8-bit data in each character. It is invalid for the start, end, and check bits.

During the generation of the CRC values, the "exclusive or" (XOR) operation is performed on the each 8-bit character and the content in the register. The result is placed in the bits from the least significant bit (LSB) to the most significant bit (MSB), and 0 is placed in the MSB. Then, LSB is detected. If LSB is 1, the XOR operation is performed on the current value in the register and the preset value. If LSB is 0, no operation is performed. This process is repeated 8 times. After the last bit (8th bit) is detected and processed, the XOR operation is performed on the next 8-bit byte and the current content in the register. The final values in the register are the CRC values obtained after operations are performed on all the bytes in the frame.

The calculation adopts the international standard CRC check rule. You can refer to the related standard CRC algorithm to compile the CRC calculation program as required.

The following is a simple CRC calculation function for your reference (using the C programming language):

```
unsigned int  crc_cal_value(unsigned char*data_value,unsigned char
data_length)
{
    int i;
    unsigned int crc_value=0xffff;
    while(data_length--)
    {
        crc_value^=*data_value++;
        for(i=0;i<8;i++)
        {
            if(crc_value&0x0001)
                crc_value=(crc_value>>1)^0xa001;
            else
```

```

        crc_value=crc_value>>1;
    }
}
return(crc_value);
}

```

In the ladder logic, CKSM uses the table look-up method to calculate the CRC value according to the content in the frame. The program of this method is simple, and the calculation is fast, but the ROM space occupied is large. Use this program with caution in scenarios where there are space occupation limits on programs.

9.4 RTU command code and communication data

9.4.1 Command code: 03H, reading N words (continuously reading a maximum of 16 words)

The command code 03H is used by the master to read data from the inverter. The quantity of data to be read depends on the "data quantity" in the command. A maximum of 16 pieces of data can be read. The addresses of the read parameters must be contiguous. Each piece of data occupies 2 bytes, that is, one word. The command format is presented using the hexadecimal system (a number followed by "H" indicates a hexadecimal value). One hexadecimal value occupies one byte.

The 03H command is used to read information including the parameters and operation state of the inverter.

For example, starting from the data address of 0004H, to read two contiguous pieces of data (that is, to read content from the data addresses 0004H and 0005H), the structure of the frame is described in the following table.

RTU master command (transmitted by the master to the inverter)

START	T1-T2-T3-T4 (transmission time of 3.5 bytes)
ADDR (address)	01H
CMD (command code)	03H
Most significant byte (MSB) of the start address	00H
Least significant byte (LSB) of the start address	04H
MSB of data quantity	00H
LSB of data quantity	02H
LSB of CRC	85H
MSB of CRC	CAH
END	T1-T2-T3-T4 (transmission time of 3.5 bytes)

The value in START and END is "T1-T2-T3-T4 (transmission time of 3.5 bytes)", indicating that the RS485 needs to stay idle for at least the transmission time of 3.5 bytes. An idle time is required to distinguish on message from another to ensure that the two messages are not regarded as one.

The value of ADDR is 01H, indicating that the command is transmitted to the inverter whose address is 01H. The ADDR information occupies one byte.

The value of CMD is 03H, indicating that the command is used to read data from the inverter. The CMD information occupies one byte.

"Start address" indicates that data reading is started from this address. It occupies two bytes, with the MSB on the left and LSB on the right.

"Data quantity" indicates the quantity of data to be read (unit: word).

The value of "Start address" is 0004H, and that of "Data quantity" is 0002H, indicating that data is to be read from the data addresses of 0004H and 0005H.

CRC check occupies two bytes, with the LSB on the left, and MSB on the right.

RTU slave response (transmitted by the inverter to the master)

START	T1-T2-T3-T4 (transmission time of 3.5 bytes)
ADDR	01H
CMD	03H
Number of bytes	04H
MSB of data in 0004H	13H
LSB of data in 0004H	88H
MSB of data in 0005H	00H
LSB of data in 0005H	00H
LSB of CRC	7EH
MSB of CRC	9DH
END	T1-T2-T3-T4 (transmission time of 3.5 bytes)

The definition of the response information is described as follows:

The value of ADDR is 01H, indicating that the message is transmitted by the inverter whose address is 01H. The ADDR information occupies one byte.

The value of CMD is 03H, indicating that the message is a response of the inverter to the 03H command of the master for reading data. The CMD information occupies one byte.

"Number of bytes" indicates the number of bytes between a byte (not included) and the CRC byte (not included). The value 04 indicates that there are four bytes of data between "Number of bytes" and "LSB of CRC", that is, "MSB of data in 0004H", "LSB of data in 0004H", "MSB of data in 0005H", and "LSB of data in 0005H".

A piece of data is two bytes, with the MSB on the left and LSB on the right. From the response, we can see that the data in 0004H is 1388H, and that in 0005H is 0000H.

CRC check occupies two bytes, with the LSB on the left, and MSB on the right.

9.4.2 Command code: 06H, writing a word

This command is used by the master to write data to the inverter. One command can be used to write

only one piece of data. It is used to modify the parameters and operation mode of the inverter.

For example, to write 5000 (1388H) to 0004H of the inverter whose address is 02H, the structure of the frame is described in the following table.

RTU master command (transmitted by the master to the inverter)

START	T1-T2-T3-T4 (transmission time of 3.5 bytes)
ADDR	02H
CMD	06H
MSB of data writing address	00H
LSB of data writing address	04H
MSB of to-be-written data	13H
LSB of to-be-written data	88H
LSB of CRC	C5H
MSB of CRC	6EH
END	T1-T2-T3-T4 (transmission time of 3.5 bytes)

RTU slave response (transmitted by the inverter to the master)

START	T1-T2-T3-T4 (transmission time of 3.5 bytes)
ADDR	02H
CMD	06H
MSB of data writing address	00H
LSB of data writing address	04H
MSB of to-be-written data	13H
LSB of to-be-written data	88H
LSB of CRC	C5H
MSB of CRC	6EH
END	T1-T2-T3-T4 (transmission time of 3.5 bytes)

Note: The sections 9.4.1 and 9.4.2 mainly describes the command formats. For the detailed application, see the examples in section 9.4.8.

9.4.3 Command code: 08H, diagnosis

Sub-function code description

Sub-function code	Description
0000	Return data based on query requests

For example, to query about the circuit detection information about the inverter whose address is 01H, the query and return strings are the same, and the format is described in the following tables.

RTU master command

START	T1-T2-T3-T4 (transmission time of 3.5 bytes)
-------	--

ADDR	01H
CMD	08H
MSB of the sub-function code	00H
LSB of the sub-function code	00H
MSB of data	12H
LSB of data	ABH
LSB of CRC CHK	ADH
MSB of CRC CHK	14H
END	T1-T2-T3-T4 (transmission time of 3.5 bytes)

RTU slave response

START	T1-T2-T3-T4 (transmission time of 3.5 bytes)
ADDR	01H
CMD	08H
MSB of the sub-function code	00H
LSB of the sub-function code	00H
MSB of data	12H
LSB of data	ABH
LSB of CRC CHK	ADH
MSB of CRC CHK	14H
END	T1-T2-T3-T4 (transmission time of 3.5 bytes)

9.4.4 Command code: 10H, continuous writing

The command code 10H is used by the master to write data to the inverter. The quantity of data to be written is determined by "Data quantity", and a maximum of 16 pieces of data can be written.

For example, to write 5000 (1388H) and 50 (0032H) respectively to 0004H and 0005H of the inverter whose slave address is 02H, the structure of the frame is described in the following table.

RTU master command (transmitted by the master to the inverter)

START	T1-T2-T3-T4 (transmission time of 3.5 bytes)
ADDR	02H
CMD	10H
MSB of data writing address	00H
LSB of data writing address	04H
MSB of data quantity	00H
LSB of data quantity	02H
Number of bytes	04H
MSB of data to be written to 0004H	13H
LSB of data to be written to 0004H	88H
MSB of data to be written to 0005H	00H
LSB of data to be written to 0005H	32H
LSB of CRC	C5H

MSB of CRC	6EH
END	T1-T2-T3-T4 (transmission time of 3.5 bytes)

RTU slave response (transmitted by the inverter to the master)

START	T1-T2-T3-T4 (transmission time of 3.5 bytes)
ADDR	02H
CMD	10H
MSB of data writing address	00H
LSB of data writing address	04H
MSB of data quantity	00H
LSB of data quantity	02H
LSB of CRC	C5H
MSB of CRC	6EH
END	T1-T2-T3-T4 (transmission time of 3.5 bytes)

9.4.5 Data address definition

This section describes the address definition of communication data. The addresses are used for controlling the running, obtaining the state information, and setting related function parameters of the inverter.

9.4.5.1 Function code address representation rules

The address of a function code consists of two bytes, with the MSB on the left and LSB on the right. The MSB ranges from 00 to ffH, and the LSB also ranges from 00 to ffH. The MSB is the hexadecimal form of the group number before the dot mark, and LSB is that of the number behind the dot mark. Take P05.06 as an example, the group number is 05, that is, the MSB of the parameter address is the hexadecimal form of 05; and the number behind the dot mark is 06, that is, the LSB is the hexadecimal form of 06. Therefore, the function code address is 0506H in the hexadecimal form. For P10.01, the parameter address is 0A01H.

Function code	Name	Description	Default value	Modify
P10.00	Simple PLC mode	0: Stop after running once 1: Keep running in the final value after running once 2: Cyclic running	0	<input type="radio"/>
P10.01	Simple PLC memory selection	0: No memory after power down 1: Memory after power down	0	<input type="radio"/>

Note:

- The parameters in the P99 group are set by the manufacturer. They cannot be read or modified. Some parameters cannot be modified when the inverter is running; some cannot be modified regardless of the state of the inverter. Pay attention to the setting range, unit, and related description of a parameter when modifying it.

2. The service life of the Electrically Erasable Programmable Read-Only Memory (EEPROM) may be reduced if it is frequently used for storage. For users, some function codes do not need to be stored during communication. The application requirements can be met by modifying the value of the on-chip RAM, that is, modifying the MSB of the corresponding function code address from 0 to 1. For example, if P00.07 is not to be stored in the EEPROM, you need only to modify the value of the RAM, that is, set the address to 8007H. The address can be used only for writing data to the on-chip RAM, and it is invalid when used for reading data.

9.4.5.2 Description of other function code addresses

In addition to modifying the parameters of the inverter, the master can also control the inverter, such as start and stop it, and monitor the operation state of the inverter. The following table describes other function parameters.

Function	Address	Data description	R/W
Communication-based control command	2000H	0001H: Forward running	R/W
		0002H: Reverse running	
		0003H: Forward jogging	
		0004H: Reverse jogging	
		0005H: Stop	
		0006H: Coast to stop	
		0007H: Fault reset	
		0008H: Jogging to stop	
Communication-based value setting	2001H	Communication-based frequency setting (0–Fmax, unit: 0.01 Hz)	R/W
	2002H	PID setting, range (0–1000, 1000 corresponding to 100.0%)	
	2003H	PID feedback, range (0–1000, 1000 corresponding to 100.0%)	R/W
	2004H	Torque setting (-3000–+3000, 1000 corresponding to 100.0% of the rated current of the motor)	R/W
	2005H	Setting of the upper limit of the forward running frequency (0–Fmax, unit: 0.01 Hz)	R/W
	2006H	Setting of the upper limit of the reverse running frequency (0–Fmax, unit: 0.01 Hz)	R/W
	2007H	Upper limit of the electromotion torque (0–3000, 1000 corresponding to 100.0% of the rated current of the inverter)	R/W
	2008H	Upper limit of the brake torque (0–3000, 1000 corresponding to 100.0% of the rated current of the motor)	R/W
	2009H	Special control command word: Bit1–0 =00: Motor 1 =01: Motor 2	R/W

Function	Address	Data description	R/W
		=10: Motor 3 =11: Motor 4 Bit2: =1 Torque control disabled =0: Torque control cannot be disabled Bit3: =1 Power consumption reset to 0 =0: Power consumption not reset Bit4: =1 Pre-excitation =0: Pre-excitation disabled Bit5: =1 DC brake =0: DC brake disabled	
	200AH	Virtual input terminal command, range: 0x000–0x1FF	R/W
	200BH	Virtual output terminal command, range: 0x00–0x0F	R/W
	200CH	Voltage setting (used when V/F separation is implemented) (0–1000, 1000 corresponding to 100.0% of the rated voltage of the motor)	R/W
	200DH	AO output setting 1 (-1000→+1000, 1000 corresponding to 100.0%)	R/W
	200EH	AO output setting 2 (-1000→+1000, 1000 corresponding to 100.0%)	R/W
Inverter state word 1	2100H	0001H: Forward running	R
		0002H: Reverse running	
		0003H: Stopped	
		0004H: Faulty	
		0005H: POFF	
		0006H: Pre-excited	
Inverter state word 2	2101H	Bit0: =0: Not ready to run =1: Ready to run Bit2–1: =00: Motor 1 =01: Motor 2 =10: Motor 3 =11: Motor 4 Bit3: =0: Asynchronous machine =1: Synchronous machine Bit4: =0: No overload alarm =1: Overload alarm Bit6–5: =00: Keypad-based control =01: Terminal-based control =10: Communication-based control Bit7: Reserved Bit8: =0: Speed control =1: Torque control Bit9: =0: Non-position control =1: Position control Bit11–10: =0: Vector 0 =1: Vector 1 =2: Closed-loop vector =3: Space voltage vector	R

Function	Address	Data description	R/W
Inverter fault code	2102H	See the description of fault types.	R
Inverter identification code	2103H	G500-----0x01a1	R
Running frequency	3000H	0-Fmax (unit: 0.01Hz)	R
Set frequency	3001H	0-Fmax (unit: 0.01Hz)	R
Bus voltage	3002H	0.0-2000.0 V (unit: 0.1V)	R
Output voltage	3003H	0-1200V (unit: 1V)	R
Output current	3004H	0.0-3000.0A (unit: 0.1A)	R
Rotating speed	3005H	0-65535 (unit: 1RPM)	R
Output power	3006H	-300.0-+300.0% (unit: 0.1%)	R
Output torque	3007H	-250.0-+250.0% (unit: 0.1%)	R
Closed-loop setting	3008H	-100.0-+100.0% (unit: 0.1%)	R
Closed-loop feedback	3009H	-100.0-+100.0% (unit: 0.1%)	R
Input state	300AH	0x000-0x1FF	R
Output state	300BH	0x000-0x1FF	R
Analog input 1	300CH	0.00-10.00V (unit: 0.01V)	R
Analog input 2	300DH	0.00-10.00V (unit: 0.01V)	R
Analog input 3	300EH	-10.00-10.00V (unit: 0.01V)	R
Analog input 4	300FH		R
Read input of high-speed pulse 1	3010H	0.00-50.00kHz (unit: 0.01Hz)	R
Read input of high-speed pulse 2	3011H		R
Read current step of multi-step speed	3012H	0-15	R
External length	3013H	0-65535	R
External count value	3014H	0-65535	R
Torque setting	3015H	-300.0-+300.0% (unit: 0.1%)	R
Identification code	3016H		R
Fault code	5000H		R

Compatible
with CHF100A
and CHV100
communication
addresses

The Read/Write (R/W) characteristics indicate whether a function can be read and written. For example, "Communication-based control command" can be written, and therefore the command code 6H is used to control the inverter. The R characteristic indicates that a function can only be read, and W indicates that a function can only be written.

Note: Some parameters in the preceding table are valid only after they are enabled. Take the running and stop operations as examples, you need to set "Running command channel" (P00.01) to "Communication", and set "Communication running command channel" (P00.02) to the Modbus communication channel. For another example, when modifying "PID setting", you need to set "PID

reference source" (P09.00) to Modbus communication.

The following table describes the encoding rules of device codes (corresponding to the identification code 2103H of the inverter).

8 MSBs	Meaning	8 LSBs	Meaning
0x01	G	0xa1	G500 vector inverter

9.4.6 Fieldbus scale

In practical applications, communication data is represented in the hexadecimal form, but hexadecimal values cannot represent decimals. For example, 50.12 Hz cannot be represented in the hexadecimal form. In such cases, we can multiply 50.12 by 100 to obtain an integer 5012, and then 50.12 can be represented as 1394H (5012 in the decimal form) in the hexadecimal form.

In the process of multiplying a non-integer by a multiple to obtain an integer, the multiple is referred to as a fieldbus scale.

The fieldbus scale depends on the number of decimals in the value specified in "Description" or "Default value". If there are n decimals in the value, the fieldbus scale m is the n^{th} -power of 10. Take the following table as an example, m is 10.

Function code	Name	Description	Default value
P01.20	Wake-up-from-sleep delay	0.0–3600.0s (valid when the ones place of P01.19 is 2)	0.0s
P01.21	Restart after power cut	0: Restart is disabled 1: Restart is enabled	0

The value specified in "Description" or "Default value" contains one decimal, so the fieldbus scale is 10. If the value received by the upper computer is 50, the value of "Wake-up-from-sleep delay" of the inverter is 5.0 (5.0=50/10).

To set the "Wake-up-from-sleep delay" to 5.0s through Modbus communication, you need first to multiply 5.0 by 10 according to the scale to obtain an integer 50, that is, 32H in the hexadecimal form, and then transmit the following write command:

<u>01</u>	<u>06</u>	<u>01 14</u>	<u>00 32</u>	<u>49 E7</u>
Inverter address	Write command	Parameter address	Parameter data	CRC

After receiving the command, the inverter converts 50 into 5.0 based on the fieldbus scale, and then sets "Wake-up-from-sleep delay" to 5.0s.

For another example, after the upper computer transmits the "Wake-up-from-sleep delay" parameter read command, the master receives the following response from the inverter:

<u>01</u>	<u>03</u>	<u>02</u>	<u>00 32</u>	<u>39 91</u>
Inverter address	Read command	2-byte data	Parameter data	CRC

The parameter data is 0032H, that is, 50, so 5.0 is obtained based on the fieldbus scale (50/10=5.0). In this case, the master identifies that the "Wake-up-from-sleep delay" is 5.0s.

9.4.7 Error message response

Operation errors may occur in communication-based control. For example, some parameters can only be read, but a write command is transmitted. In this case, the inverter returns an error message response.

Error message responses are transmitted by the inverter to the master. The following table describes the codes and definitions of the error message responses.

Code	Name	Definition
01H	Invalid command	The command code received by the upper computer is not allowed to be executed. The possible causes are as follows: <ul style="list-style-type: none"> • The function code is applicable only on new devices and is not implemented on this device. • The slave is in the faulty state when processing this request.
02H	Invalid data address	For the inverter, the data address in the request of the upper computer is not allowed. In particular, the combination of the register address and the number of the to-be-transmitted bytes is invalid.
03H	Invalid data bit	The received data domain contains a value that is not allowed. The value indicates the error of the remaining structure in the combined request. Note: It does not mean that the data item submitted for storage in the register includes a value unexpected by the program.
04H	Operation failure	The parameter is set to an invalid value in the write operation. For example, a function input terminal cannot be set repeatedly.
05H	Password error	The password entered in the password verification address is different from that set in P07.00.
06H	Data frame error	The length of the data frame transmitted by the upper computer is incorrect, or in the RTU format, the value of the CRC check bit is inconsistent with the CRC value calculated by the lower computer
07H	Parameter read-only	The parameter to be modified in the write operation of the upper computer is a read-only parameter.
08H	Parameter cannot be modified in running	The parameter to be modified in the write operation of the upper computer cannot be modified during the running of the inverter.

Code	Name	Definition
09H	Password protection	A user password is set, and the upper computer does not provide the password to unlock the system when performing a read or write operation. The error of "system locked" is reported.

When returning a response, the device uses a function code domain and fault address to indicate whether it is a normal response (no error) or exception response (some errors occur). In a normal response, the device returns the corresponding function code and data address or sub-function code. In an exception response, the device returns a code that is equal to a normal code, but the first bit is logic 1.

For example, if the master device transmits a request message to a slave device for reading a group of function code address data, the code is generated as follows:

0 0 0 0 0 1 1 (03H in the hexadecimal form)

For a normal response, the same code is returned.

For an exception response, the following code is returned:

1 0 0 0 0 1 1 (83H in the hexadecimal form)

In addition to the modification of the code, the slave returns a byte of exception code that describes the cause of the exception. After receiving the exception response, the typical processing of the master device is to transmit the request message again or modify the command based on the fault information.

For example, to set the "Running command channel" (P00.01, the parameter address is 0001H) of the inverter whose address is 01H to 03, the command is as follows:

01 **06** **00 01** **00 03** **98 0B**
 Inverter Write Parameter Parameter CRC
 address command address data

But the setting range of the "Running command channel" is 0 to 2. The value 3 exceeds the setting range. In this case, the inverter returns an error message response as shown in the following:

01 **86** **04** **43 A3**
 Inverter Exception Error code CRC
 address response code

The exception response code 86H (generated based on the MSB "1" of the write command 06H) indicates that it is an exception response to the write command (06H). The error code is 04H. From the preceding table, we can see that it indicates the error "Operation failure", which means "The parameter is set to an invalid value in the write operation".

9.4.8 Read/Write operation example

For the formats of the read and write commands, see Sections 9.4.1 and 9.4.2.

9.4.8.1 Read command 03H examples

Example 1: Read state word 1 of the inverter whose address is 01H. From the table of other function

parameters, we can see that the parameter address of state word 1 of the inverter is 2100H.

The read command transmitted to the inverter is as follows:

<u>01</u>	<u>03</u>	<u>21 00</u>	<u>00 01</u>	<u>8E 36</u>
Inverter address	Read command	Parameter address	Data quantity	CRC

Assume that the following response is returned:

<u>01</u>	<u>03</u>	<u>02</u>	<u>00 03</u>	<u>F8 45</u>
Inverter address	Read command	Number of bytes	Data content	CRC

The data content returned by the inverter is 0003H, which indicates that the inverter is in the stopped state.

Example 2: View information about the inverter whose address is 03H, including "Type of current fault" (P07.27) to "Type of last but four fault" (P07.32) of which the parameter addresses are 071BH to 0720H (contiguous 6 parameter addresses starting from 071BH).

The command transmitted to the inverter is as follows:

<u>03</u>	<u>03</u>	<u>07 1B</u>	<u>00 06</u>	<u>B5 59</u>
Inverter address	Read command	Start address	6 parameters in total	CRC

Assume that the following response is returned:

<u>03</u>	<u>03</u>	<u>0C</u>	<u>00 23</u>	<u>00 23</u>	<u>00 23</u>	<u>00 23</u>	<u>00 23</u>	<u>00 23</u>	<u>00 23</u>	<u>5F D2</u>
Inverter address	Read command	Number of bytes	Type of current fault	Type of last fault	Type of last but one fault	Type of last but two fault	Type of last but three fault	Type of last but four fault		CRC

From the returned data, we can see that all the fault types are 0023H, that is, 35 in the decimal form, which means the maladjustment fault (STo)

9.4.8.2 Write command 06H examples

Example 1: Set the inverter whose address is 03H to be forward running. Refer to the table of other function parameters, the address of "Communication-based control command" is 2000H, and 0001H indicates forward running, as shown in the following figure.

Function	Address	Data description	R/W
Communication-based control command	2000H	0001H: Forward running	R/W
		0002H: Reverse running	
		0003H: Forward jogging	
		0004H: Reverse jogging	
		0005H: Stop	
		0006H: Coast to stop	
		0007H: Fault reset	
		0008H: Jogging to stop	

The command transmitted by the master is as follows:

<u>03</u>	<u>06</u>	<u>20 00</u>	<u>00 01</u>	<u>42 28</u>
Inverter address	Write command	Parameter address	Forward running	CRC

If the operation is successful, the following response is returned (same as the command transmitted by the master):

<u>03</u>	<u>06</u>	<u>20 00</u>	<u>00 01</u>	<u>42 28</u>
Inverter address	Write command	Parameter address	Forward running	CRC

Example 2: Set the "Max. output frequency" of the inverter whose address is 03H to 100 Hz.

Function code	Name	Description	Default value	Modify
P00.03	Max. output frequency	Used to set the maximum output frequency of the inverter. It is the basis of frequency setting and the acceleration/deceleration. Setting range: Max (P00.04, 10.00) –630.00Hz	60.00Hz	⊙

From the number of decimals, we can see that the fieldbus scale of the "Max. output frequency" (P00.03) is 100. Multiply 100 Hz by 100. The value 10000 is obtained, and it is 2710H in the hexadecimal form.

The command transmitted by the master is as follows:

<u>03</u>	<u>06</u>	<u>00 03</u>	<u>27 10</u>	<u>62 14</u>
Inverter address	Write command	Parameter address	Parameter data	CRC

If the operation is successful, the following response is returned (same as the command transmitted by the master):

<u>03</u>	<u>06</u>	<u>00 03</u>	<u>27 10</u>	<u>62 14</u>
Inverter address	Write command	Parameter address	Parameter data	CRC

Note: In the preceding command description, spaces are added to a command just for explanatory purposes. In practical applications, no space is required in the commands.

9.4.8.3 Continuously write command 10H examples

Example 1: Set the inverter whose address is 01H to be forward running at the frequency of 10 Hz. Refer to the table of other function parameters, the address of "Communication-based control command" is 2000H, 0001H indicates forward running, and the address of "Communication-based value setting" is 2001H, as shown in the following figure. 10 Hz is 03E8H in the hexadecimal form.

Function	Address	Data description	R/W
Communication-based control command	2000H	0001H: Forward running	R/W
		0002H: Reverse running	
		0003H: Forward jogging	
		0004H: Reverse jogging	
		0005H: Stop	
		0006H: Coast to stop	
		0007H: Fault reset	
		0008H: Jogging to stop	
Communication-based value setting	2001H	Communication-based frequency setting (0–Fmax, unit: 0.01 Hz)	R/W
	2002H	PID setting, range (0–1000, 1000 corresponding to 100.0%)	

In the actual operation, set P00.01 to 2 and P00.06 to 8.

The command transmitted by the master is as follows:

01 **10** **20 00** **00 02** **04** **00 01** **03 E8** **3B 10**
 Inverter Continuous Parameter Parameter Number of Forward 10 Hz CRC
 address write address quantity bytes running
 command

If the operation is successful, the following response is returned:

01 **10** **20 00** **00 02** **4A 08**
 Inverter Continuous Parameter Parameter CRC
 address write address quantity
 command

Example 2: Set "Acceleration time" of the inverter whose address is 01H to 10s, and "Deceleration time" to 20s.

Function code	Name	Description	Default value	Modify
P00.11	Acceleration time 1	Acceleration time is the time needed for accelerating from 0Hz to Max. output frequency (P00.03).	Depend on model	○
P00.12	Deceleration time 1	Deceleration time is the time needed from decelerating from Max. output frequency (P00.03) to 0Hz. G500 series inverter defines four groups of acceleration and deceleration time, which can be selected via multi-function digital input terminals (P05 group). The acceleration/deceleration time of the inverter is the first group by default. Setting range of P00.11 and P00.12: 0.0–3600.0s	Depend on model	○

The address of P00.11 is 000B, 10s is 0064H in the hexadecimal form, and 20s is 00C8H in the hexadecimal form.

The command transmitted by the master is as follows:

01	10	00 0B	00 02	04	00 64	00 C8	F2 55
Inverter address	Continuous write command	Parameter address	Parameter quantity	Number of bytes	10s	20s	CRC

If the operation is successful, the following response is returned:

01	10	00 0B	00 02	30 0A
Inverter address	Continuous write command	Parameter address	Parameter quantity	CRC

Note: In the preceding command description, spaces are added to a command just for explanatory purposes. In practical applications, no space is required in the commands.

9.4.8.4 Modbus communication commissioning example

A PC is used as the host, an RS232-RS485 converter is used for signal conversion, and the PC serial port used by the converter is COM1 (an RS232 port). The upper computer commissioning software is the serial port commissioning assistant Commix, which can be downloaded from the Internet. Download a version that can automatically execute the CRC check function. The following figure shows the interface of Commix.

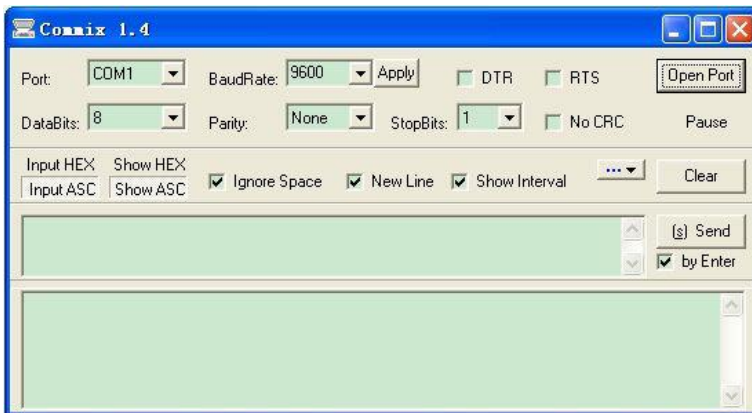

First, set the serial port to **COM1**. Then, set the baud rate consistently with P14.01. The data bits, check bits, and end bits must be set consistently with P14.02. If the RTU mode is selected, you need to select the hexadecimal form **Input HEX**. To set the software to automatically execute the CRC function, you need to select **ModbusRTU**, select **CRC16 (MODBU SRTU)**, and set the start byte to 1. After the auto CRC check function is enabled, do not enter CRC information in commands. Otherwise, command errors may occur due to repeated CRC check.

The commissioning command to set the inverter whose address is 03H to be forward running is as follows:

<u>03</u>	<u>06</u>	<u>20 00</u>	<u>00 01</u>	<u>42 28</u>
Inverter address	Write command	Parameter address	Forward running	CRC

Note:

1. Set the address (P14.00) of the inverter to 03.
2. Set "Channel of running commands" (P00.01) to "Communication", and set "Communication channel of running commands" (P00.02) to the Modbus communication channel.
3. Click **Send**. If the line configuration and settings are correct, a response transmitted by the inverter is received as follows:

<u>03</u>	<u>06</u>	<u>20 00</u>	<u>00 01</u>	<u>42 28</u>
Inverter address	Write command	Parameter address	Forward running	CRC

9.5 Common communication faults

Common communication faults include the following:

- No response is returned.
- The inverter returns an exception response.

Possible causes of no response include the following:

- The serial port is set incorrectly. For example, the converter uses the serial port COM1, but COM2 is selected for the communication.
- The settings of the baud rates, data bits, end bits, and check bits are inconsistent with those set on the inverter.
- The positive pole (+) and negative pole (-) of the RS485 bus are connected reversely.
- The resistor connected to 485 terminals on the terminal block of the inverter is set incorrectly.

Appendix A Expansion cards

A.1 Model definition

EC-PG 5 02-05 B

① ② ③ ④ ⑤ ⑥

Field identifier	Field description	Naming example
①	Product category	EC: Expansion card
②	Card category	IC: IoT card IO: IO card PC: Programmable card PG: PG card PS: Power supply card TX: Communication card
③	Technical version	Indicates the generation of a technical version by using odd numbers, for example, 1, 3, and 5 indicate the 1 st , 2 nd , and 3 rd generations of the technical version.
④	Distinguishing code	02: Sine/Cosine PG card + pulse direction setting + frequency-divide output
		03: UVW PG interface + pulse direction setting + frequency-divide output
		04: Resolver PG interface + pulse direction setting + frequency-divide output
		05: Incremental PG card + pulse direction setting + frequency-divide output
		06: Absolute PG interface + pulse direction setting + frequency-divide output
		07: Simple incremental PG card
⑤	Working power	00: Passive
		05: 5V
		12: 12–15 V
		24: 24 V
⑥	Expansion card version	Empty: Version A B: Version B C: Version C

EC-PC 5 02-00

① ② ③ ④ ⑤

Field identifier	Field description	Naming example
①	Product category	EC: Expansion card
②	Card category	IC: IoT card IO: IO card PC: Programmable card PG: PG card PS: Power supply card TX: Communication card
③	Technical version	Indicates the generation of a technical version by using odd numbers, for example, 1, 3, and 5 indicate the 1 st , 2 nd , and 3 rd generations of the technical version.
④	Distinguishing code	01: 10 points, 6 inputs and 4 outputs (2 transistor outputs + 2 relay outputs)
		02: 14 points, 8 inputs and 6 outputs (relay outputs)
		03: Reserved
⑤	Special requirement	Reserved. The default value is 00.

EC-TX 5 01 B

① ② ③ ④ ⑤

Field identifier	Field description	Naming example
①	Product category	EC: Expansion card
②	Card category	IC: IoT card IO: IO card PC: Programmable card PG: PG card PS: Power supply card TX: Communication card
③	Technical version	Indicates the generation of a technical version by using odd numbers, for example, 1, 3, and 5 indicate the 1 st , 2 nd , and 3 rd generations of the technical version.

Field identifier	Field description	Naming example
④	Distinguishing code	01: Bluetooth communication card
		02: WIFI communication card
		03: PROFIBUS communication card
		05: CAN multi-protocol communication card
		06: DeviceNet communication card
		07: BACnet communication card
		08: EtherCAT communication card
		09: PROFINET communication card
		10: Ethernet/IP communication card
		15: Modbus TCP communication card
⑤	Expansion card version	Empty: Version A B: Version B C: Version C

EC-IO 5 01-00

① ② ③ ④ ⑤

Field identifier	Field description	Naming example
①	Product category	EC: Expansion card
②	Card category	IC: IoT card IO: IO card PC: Programmable card PG: PG card PS: Power supply card TX: Communication card
③	Technical version	Indicates the generation of a technical version by using odd numbers, for example, 1, 3, and 5 indicate the 1 st , 2 nd , and 3 rd generations of the technical version.
④	Distinguishing code	01: Multiple-function I/O expansion card (4 digital inputs, 1 digital output, 1 analog input, 1 analog output, and 2 relay outputs)
		02: Digital I/O card
		03: Analog I/O card
		04: Reserved 1
		05: Reserved 2
⑤	Special requirement	

EC - IC 5 01 - 2 1 G

① ② ③ ④ ⑤ ⑥ ⑦

Field identifier	Field description	Naming example
①	Product category	EC: Expansion card
②	Card category	IC: IoT card IO: IO card PC: Programmable card PG: PG card PS: Power supply card TX: Communication card
③	Technical version	Indicates the generation of technical version by using an odd number. For example, 1, 3, 5, and 7 indicate the 1st, 2nd, 3rd and 4th generations of technical version.
④	Distinguishing code	01: GPRS card 02: 4G card 03: Reserved
⑤	Antenna type	1: Internal 2: External
⑥	SIM card type	0: Plug-in (standard) 1: Surface mounted Note: When this field is 0 or omitted, the SIM card type is plug-in.
⑦	Special requirement	G: With GPS S: Surface mounted SIM card Note: When this field is omitted, the expansion card does not have special functions.

EC - IC 5 02 - 2 1 G - CN

① ② ③ ④ ⑤ ⑥ ⑦ ⑧

Field identifier	Field description	Naming example
①	Product category	EC: Expansion card
②	Card category	IC: IoT card IO: IO card PC: Programmable card PG: PG card PS: Power supply card TX: Communication card

Field identifier	Field description	Naming example
③	Technical version	Indicates the generation of technical version by using an odd number. For example, 1, 3, 5, and 7 indicate the 1st, 2nd, 3rd and 4th generations of technical version.
④	Distinguishing code	01: GPRS card
		02: 4G card
		03: Reserved
⑤	Antenna type	1: Built-in
		2: External
⑥	SIM card type	0: Plug-in 1: Surface mounted Note: When this field is 0 or omitted, the SIM card type is plug-in.
⑦	Special function	G: GPS function Note: When this field is omitted, the expansion card does not have special functions
⑧	International version	CN: China version EU: Europe version LA: Latin America version Note: A 4G SIM card is a standard configuration for the CN version, but not for the EU or LA version.

The following table describes expansion cards that G500 series inverters support. The expansion cards are optional and need to be purchased separately

Name	Model	Specification
IO expansion card 1	EC-IO501-00	<ul style="list-style-type: none"> ● 4 digital inputs ● 1 digital output ● 1 analog input ● 1 analog output ● 2 relay outputs: 1 double-contact output, and 1 single-contact output
IO expansion card 2	EC-IO502-00	<ul style="list-style-type: none"> ● 4 digital inputs ● 1 PT100 ● 1 PT1000 ● 2 relay outputs: single-contact output
Programmable expansion card	EC-PC502-00	<ul style="list-style-type: none"> ● Adopting the global mainstream development environment PLC, supporting multiple types of programming languages, such as the instruction

Name	Model	Specification
		<p>language, structural text, function block diagram, ladder diagram, continuous function chart, and sequential function chart</p> <ul style="list-style-type: none"> ● Supporting breakpoint commissioning and periodic task run mode selection ● Providing user program storage space of 16K steps, and data storage space of 8K words ● 6 digital inputs ● 2 relay outputs ● 1 AI and 1 AO ● 1 RS485 communication channel, supporting the host controller to switch the master/slave ● Saving data of 1K words at power down
Bluetooth communication card	EC-TX501-1 EC-TX501-2	<ul style="list-style-type: none"> ● Supporting Bluetooth 4.0 ● With Galt Electric mobile app, you can set the parameters and monitor the states of the inverter through Bluetooth ● The maximum communication distance in open environments is 30 m. ● EC-TX501-1 is equipped with a built-in antenna and applicable to molded case machines. ● EC-TX501-2 is configured with an external sucker antenna and applicable to sheet metal machines.
WIFI communication card	EC-TX502-1 EC-TX502-2	<ul style="list-style-type: none"> ● Meeting IEEE802.11b/g/n ● With the Galt Electric mobile app, you can monitor the inverter locally or remotely through WIFI communication ● The maximum communication distance in open environments is 30 m. ● EC-TX501-1 is equipped with a built-in antenna and applicable to molded case machines. ● EC-TX501-2 is configured with an external sucker antenna and applicable to sheetmetal machines.
PROFIBUS-DP communication card	EC-TX503	<ul style="list-style-type: none"> ● Supporting the PROFIBUS-DP protocol
Ethernet communication card	EC-TX504	<ul style="list-style-type: none"> ● Supporting Ethernet communication with the manufacturer's internal protocol ● Can be used in combination with the manufacturer's upper computer monitoring software

Name	Model	Specification
CAN multi-protocol communication card	EC-TX505C	<ul style="list-style-type: none"> ● Based on the CAN2.0A and CAN2.0B physical layer ● Supporting the CANopen protocol ● Adopting the manufacturer's master-slave control proprietary protocol
PROFINET communication card	EC-TX509	<ul style="list-style-type: none"> ● Supporting the PROFINET protocol
Ethernet/IP communication card	EC-TX510	<ul style="list-style-type: none"> ● Supporting the Ethernet IP protocol and ODVA protocol ● With two Ethernet IP ports, supporting 10/100M half/full duplex operating ● Supporting star, line, and ring network topologies (but not supporting ring network monitoring)
Modbus TCP communication card	EC-TX515	<ul style="list-style-type: none"> ● With two Modbus TCP IO ports, supporting 100M full duplex operating, and supporting line and star network topologies, with the nodes up to 32 ● Able to function as a Modbus TCP slave
Sin/Cos PG card	EC-PG502	<ul style="list-style-type: none"> ● Applicable to Sin/Cos encoders with or without CD signals ● Supporting A, B, Z frequency-divided output ● Supporting input of pulse string reference
UVW incremental PG card	EC-PG503-05	<ul style="list-style-type: none"> ● Applicable to 5V differential encoders ● Supporting A, B, Z orthogonal input ● Supporting U, V, W 3PH pulse input ● Supporting A, B, Z frequency-divided output ● Supporting input of pulse string reference
Resolver PG card	EC-PG504-00	<ul style="list-style-type: none"> ● Applicable to resolver encoders ● Supporting simulated A, B, Z frequency-divided output of resolvers ● Supporting input of pulse string reference
Multi-function incremental PG card	EC-PG505-12	<ul style="list-style-type: none"> ● Applicable to OC encoders of 5 V or 12 V ● Applicable to push-pull encoders of 5 V or 12 V ● Applicable to differential encoders of 5 V ● Supporting the orthogonal input of A, B, and Z ● Supporting the frequency-divided output of A, B, and Z ● Supporting pulse string setting
24V incremental PG card	EC-PG505-24B	<ul style="list-style-type: none"> ● Applicable to 24V OC encoders ● Applicable to 24 V push-pull encoders ● Supporting A, B, Z orthogonal input ● Supporting A, B, Z frequency-divided output ● Supporting pulse string reference input

Name	Model	Specification
Simple incremental PG card	EC-PG507-12	<ul style="list-style-type: none"> • Applicable to 5 V or 12 V OC encoders • Applicable to 5 V or 12 V push-pull encoders • Applicable to 5 V differential encoders
24V simplified incremental PG card	EC-PG507-24	<ul style="list-style-type: none"> • Applicable to 24 V OC encoders • Applicable to 24 V push-pull encoders • Applicable to 24 V differential encoders
GPRS card	EC-IC501-2	<ul style="list-style-type: none"> • Supporting IoT monitoring • Supporting remote inverter upgrade
4G card	EC-IC502-2-CN EC-IC502-2-EU EC-IC502-2-LA	<ul style="list-style-type: none"> • Supporting standard RS485 interfaces • Supporting 4G communication



IO expansion card
EC-IO501-00



IO expansion card 2
EC-IO502-00



Programmable
expansion card
EC-PC502-00



Bluetooth/WIFI
communication card
EC-TX501/502



PROFIBUS-DP
communication card
EC-TX503



Ethernet
communication card
EC-TX504



CAN multi-protocol
communication card
EC-TX505C



PROFINET
communication card
EC-TX509



Ethernet/IP
communication card
EC-TX510/ Modbus
TCP communication
card EC-TX515



Sin/Cos PG card
EC-PG502



UVW incremental PG
card EC-PG503-05



Resolver PG card
EC-PG504-00



Multifunction
incremental PG card
EC-PG505-12



24V incremental PG
card
EC-PG505-24B



Simplified incremental
PG card
EC-PG507-12



24V simplified
incremental PG card
EC-PG507-24



GPRS card
EC-IC501-2



4G card
EC-IC502-2-CN
EC-IC502-2-EU
EC-IC502-2-LA

A.2 Dimensions and installation

All expansion cards are of the same dimensions (108 mm x 39 mm) and can be installed in the same way.

Following the following operation principles when installing or removing an expansion card:

1. Ensure that no power is applied before installing the expansion card.
2. The expansion card can be installed in any one of the SLOT1, SLOT2, and SLOT3 card slots.
3. Inverters of 5.5 kW/7.5HP or lower can be configured with two expansion cards at the same time, and those of 7.5 kW/10HP or higher can be configured with three expansion cards.
4. If interference occurs on the external wires after expansion cards are installed, change their installation card slots flexibly to facilitate the wiring. For example, the connector of the connection cable of the DP card is large, so it is recommended to be installed in the SLOT1 card slot.
5. To ensure high anti-interference capability in closed-loop control, you need to use a shielding wire in the encoder cable and ground the two ends of the shielding wire, that is, connect the shielding layer to the housing of the motor on the motor side, and connect the shielding layer to the PE terminal on the PG card side.

Figure A-1 shows the installation diagram and an inverter with expansion cards installed.

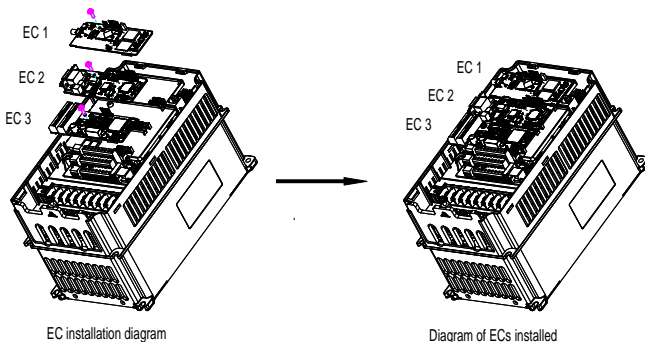

Figure A-1 Inverter of 7.5 kW/10HP or higher with expansion cards installed

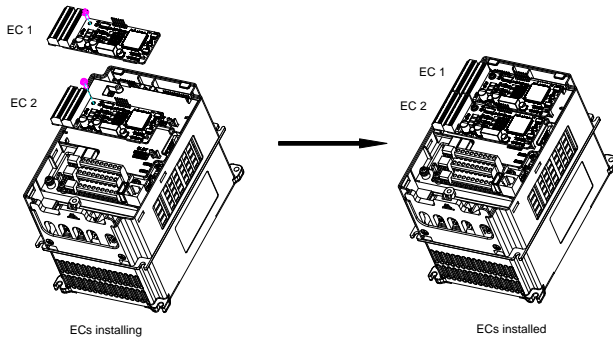

Figure A-2 Inverter of 5.5 kW/7.5HP or lower with expansion cards installed

Expansion card installation process:

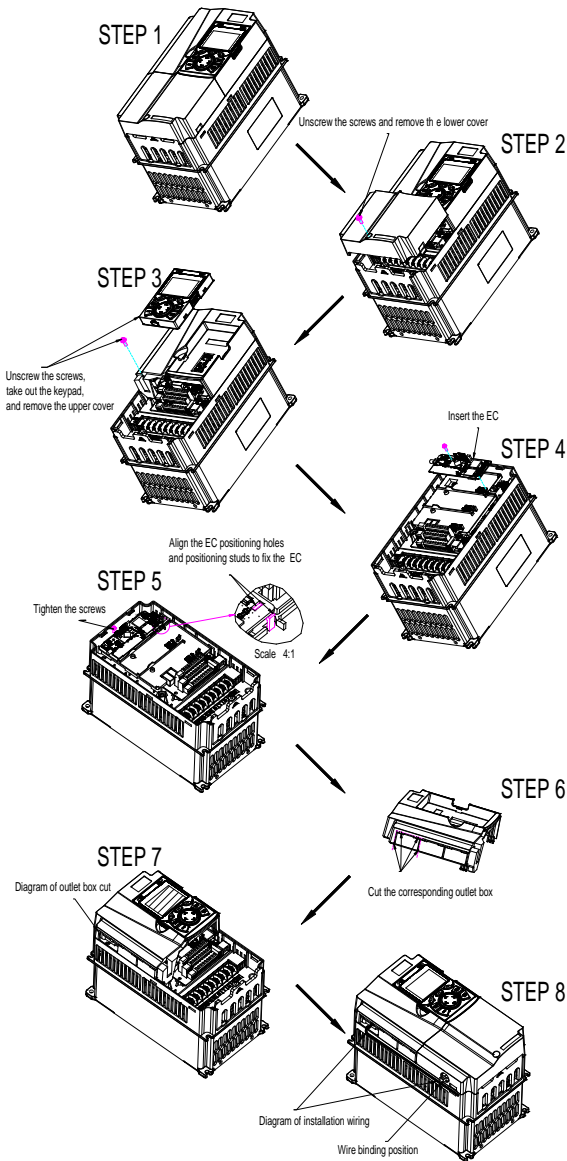

Figure A-3 Expansion card installation process diagram

A.3 Wiring

1. Ground a shielded cable as follows:

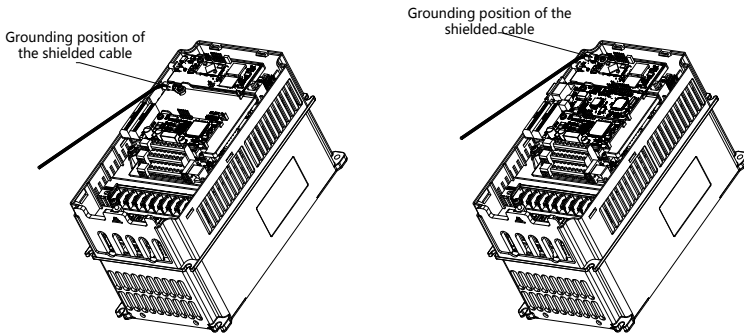

Figure A-4 Expansion card grounding diagram

2. Wire an expansion card as follows:

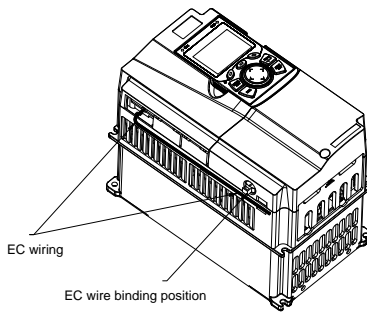
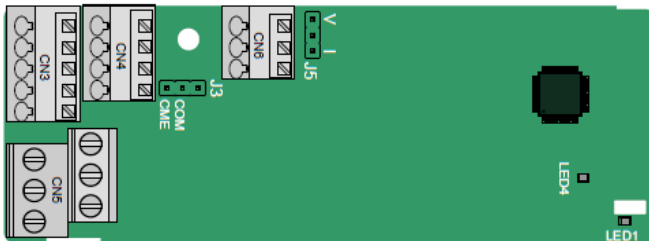

Figure A-5 Expansion card wiring

A.4 IO cards

A.4.1 IO card 1 (EC-IO501-00)



CME and COM are shorted through J3 before delivery, and J5 is the jumper for selecting the output type (voltage or current) of AO2.

The terminals are arranged as follows:

AI3	AO2	GND
-----	-----	-----

COM	CME	Y2	S5	
PW	+24V	S6	S7	S8

RO3A	RO3B	RO3C	
	RO4A		RO4C

Indicator definition

Indicator No.	Definition	Function
LED1	State indicator	On: The expansion card is establishing a connection with the control board. Blinks periodically: The expansion card is properly connected to the control board (the period is 1s, on for 0.5s, and off for the other 0.5s). Off: The expansion card is disconnected from the control board.
LED4	Power indicator	On: The control board feeds power to the expansion card.

The EC-IO501-00 expansion card can be used in scenarios where the I/O interfaces of a G500 inverter cannot meet the application requirements. It can provide 4 digital inputs, 1 digital output, 1 analog input, 1 analog output, and two relay outputs. It is user-friendly, providing relay outputs through European-type screw terminals and other inputs and outputs through spring terminals.

EC-IO501-00 terminal function description

Category	Label	Name	Function description
Power	PW	External power supply	The working power of digital input is provided by an external power supply. Voltage range: 12–24 V The terminals PW and +24V are shorted before delivery.
Analog input/output	AI3—GND	Analog input 1	1. Input range: 0–10 V, 0–20 mA 2. Input impedance: 20 k Ω for voltage input; 250 Ω for current input 3. Set it to be voltage or current input through the corresponding function code. 4. Resolution: When 10 V corresponds to 50 Hz, the minimum resolution is 5 mV. 5. Deviation: $\pm 0.5\%$; input of 5 V or 10 mA or higher at the temperature of 25°C
	AO2—GND	Analog output 1	1. Output range: 0–10 V, 0–20 mA 2. Whether it is voltage or current output is determined by J5. 3. Deviation $\pm 0.5\%$; output of 5 V or 10 mA or

Category	Label	Name	Function description
			higher at the temperature of 25°C
Digital input/output	S5—COM	Digital input 1	1. Internal impedance: 3.3 kΩ 2. Power input range: 12–30 V 3. Bidirectional input terminal 4. Max. input frequency: 1 kHz
	S6—COM	Digital input 2	
	S7—COM	Digital input 3	
	S8—COM	Digital input 4	
	Y2—CME	Digital output	1. Switch capacity: 200 mA/30 V 2. Output frequency range: 0–1 kHz 3. The terminals CME and COM are shorted through J3 before delivery.
Relay output	R03A	NO contact of relay 3	1. Contact capacity: 3A/AC 250 V, 1 A/DC 30 V 2. Do not use them as high-frequency digital outputs.
	R03B	NC contact of relay 3	
	R03C	Common contact of relay 3	
	R04A	NO contact of relay 4	
	R04C	Common contact of relay 4	

A.4.2 IO card 2 (EC-IO502-00)

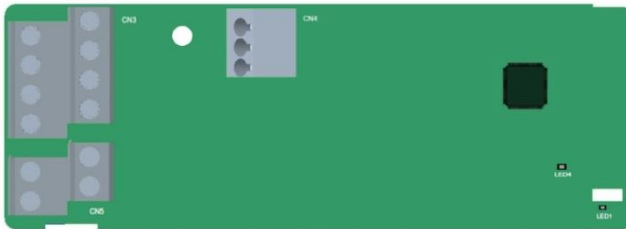

The terminals are arranged as follows.

PT1+	PT-	PT2+
------	-----	------

S5	S6	S7	S8
+24V	PW	COM	COM

RO4A	RO4C
RO3A	RO3C

Indicator definition

Indicator	Definition	Function
LED1	State indicator	This indicator is on when the expansion card is establishing a connection with the control board; it blinks

Indicator	Definition	Function
		periodically after the expansion card is properly connected to the control board (the period is 1s, on for 0.5s, and off for the other 0.5s); and it is off when the expansion card is disconnected from the control board.
LED4	Power indicator	This indicator is on after the IO expansion card is powered on by the control board.

The EC-IO502-00 expansion card can be used in scenarios where the I/O interfaces of the inverter cannot meet the application requirements. It can provide 4 digital inputs, 1 PT100 temperature measurement input (PT1+), 1 PT1000 temperature measurement input (PT2+), and 2 relay outputs. It is user-friendly, providing relay outputs and digital inputs through European-type screw terminals and temperature measurement inputs through spring terminals.

EC-IO502-00 terminal function description

Category	Symbol	Name	Function
Power	PW	External power supply	The working power of digital input is provided by an external power supply. Voltage range: 24(-20%)–48VDC(+10%), 24(-10%)–48VAC(+10%)
	+24V	Internal power	User power provided by the inverter. Max. output current: 200mA
	COM	Power reference	Common terminal of +24V
Digital input	S5—COM	Digital input 5	Internal impedance: 6.6kΩ Supported external power: 24(-20%)–48VDC(+10%), 24(-10%)–48VAC(+10%) Supporting internal power 24V Bi-directional input terminals, supporting NPN/PNP modes Max. input frequency: 1kHz All are programmable digital input terminals. You can set the terminal function via function codes.
	S6—COM	Digital input 6	
	S7—COM	Digital input 7	
	S8—COM	Digital input 8	
Temperature detection input	PT1+	PT100 input	Independent PT100 and PT1000 inputs. PT1+ connects to PT100, and PT2+ connects to PT1000. 1. Resolution: 1°C 2. Range: -20°C–150°C 3. Detection accuracy: 3°C 4. Supporting offline protection
	PT2+	PT1000 input	
	PT-	Reference input of PT100/PT1000	Zero potential reference of PT100/PT1000

Category	Symbol	Name	Function
Relay output	RO3A	Contact A of NO relay 3	RO3 relay output. RO3A: NO; RO3C: common terminal Contact capacity: 3A/AC250V, 1A/DC30V
	RO3C	Contact C of NO relay 3	
	RO4A	Contact A of NO relay 4	RO4 relay output. RO4A: NO; RO4C: common terminal Contact capacity: 3A/AC250V, 1A/DC30V
	RO4C	Contact C of NO relay 4	

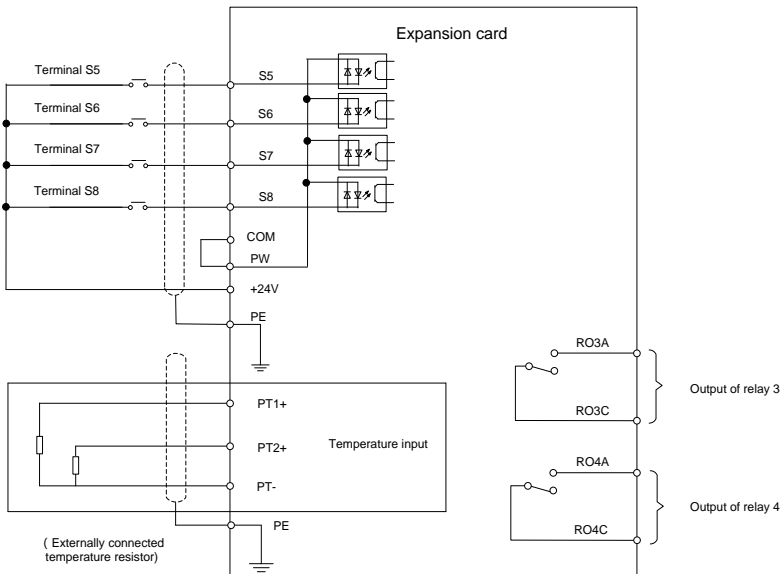
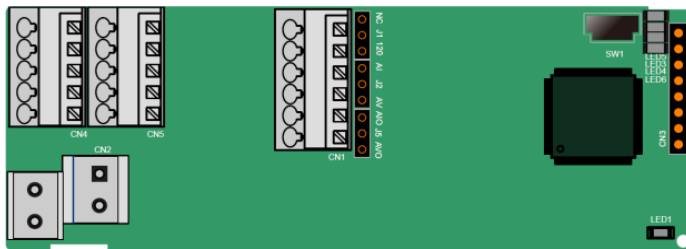

Figure 9-6 Control circuit wiring of IO expansion card 2

A.5 Programmable card (EC-PC502-00)



SW1 is the start/stop switch of the programmable expansion card. CN1 contains terminals PE, 485-, 485+, GND, AI1, and AO1, and a selection jumper resides on the next. "AI" and "AV" are the current

type input selection and voltage type input selection of AI1, and they can be selected through J2. "AIO" and "AVO" are the current type output selection and voltage type output selection of AO1, and they can be selected through J5. "120" indicates 120Ω terminal resistor, and it can connect to J1. By default, J1 connects to NC, J2 to AV, and J5 to AVO.

PE	485-	485+	GND	AI1	AO1
----	------	------	-----	-----	-----

COM	COM	PS1	PS2	PS3
PW	24V	PS4	PS5	PS6

PRO1A	PRO1C
PRO2A	PRO2C

Indicator definition

Indicator	Name	Description
LED1	PWR power indicator (green)	The indicator is on when the expansion card is powered on.
LED3	COMM communication indicator (green)	This indicator is on when the expansion card is establishing a connection with the control board; it blinks periodically after the expansion card is properly connected to the control board (the period is 1s, on for 0.5s, and off for the other 0.5s); and it is off when the expansion card is disconnected from the control board.
LED4	ERR fault indicator (red)	Blinks: an error occurs (the period is 1s, on for 0.5s, and off for the other 0.5s), and the error type can be queried through the upper computer Auto Station; Off: no fault.
LED5	PWR power indicator (green)	The indicator is on when the expansion card is powered on.
LED6	RUN status indicator (green)	On: PLC program is running Off: PLC program stops

The EC-PC502-00 programmable expansion card can replace some micro PLC applications. It adopts the global mainstream development environment PLC, supporting the instruction language (IL), ladder diagram (LD), and sequential function chart (SFC). It provides a user program storage space of 16K steps and data storage space of 8K words, and supports saving data of 1K words at power failure, which facilitate customers' secondary development and meets the customization requirements.

The EC-PC502-00 programmable expansion card provides 6 digital inputs, 2 relay outputs, 1 analog input, 1 analog output, 1 RS485 communication channel (supports master/slave switchover). It is user-friendly, providing relay outputs through European-type screw terminals and other inputs and outputs through spring terminals.

EC-PC502-00 terminal function description

Category	Symbol	Name	Function
Power supply	PW	External power supply	To provide input digital working power from external to internal. Voltage range: 12–24V PW and +24V should be short connected.
	24V	Internal power supply	Internal output power supply, 100mA
Digital input	PS1—COM	Digital input 1	<ol style="list-style-type: none"> 1. Internal impedance: 4kΩ 2. Accept 12–30V voltage input 3. Bi-directional input terminal 4. Max. input frequency: 1kHz 5. Both source and sink inputs are allowed, but the input types must be the same
	PS2—COM	Digital input 2	
	PS3—COM	Digital input 3	
	PS4—COM	Digital input 4	
	PS5—COM	Digital input 5	
	PS6—COM	Digital input 6	
Analog input and output	AI1	Analog input 1	<ol style="list-style-type: none"> 1. Input range: AI1 voltage and current range: 0–10V, 0–20mA 2. Input impedance: 20kΩ during voltage input; 250Ω during current input 3. Voltage or current input is set through the jumper. 4. Resolution ratio: When 10V corresponds to 50Hz, the min. resolution ratio is 5mV 5. Deviation: $\pm 1\%$ when the input reaches full the measurement range at 25°C
	AO1	Analog output 1	<ol style="list-style-type: none"> 1. Output range: 0–10V voltage or 0–20mA current 2. Voltage or current output is set through the jumper. 3. Deviation: $\pm 1\%$ when the input reaches full the measurement range at 25°C.
Relay output	PRO1A	NO contact of relay 1	<ol style="list-style-type: none"> 1. Contact capacity: 2A/AC250V, 1A/DC30V 2. Unable to function as high frequency switch output
	PRO1C	Common contact of relay 1	
	PRO2A	NO contact of relay 2	
	PRO2C	Common contact of relay 2	
Communication	485+	RS485 communication terminal	RS485 communication port, which can be set as the master or slave through the Auto Station. It is differential signal output. Whether to connect the 120 Ω resistor of RS485 is set through the jumper.
	485-		

For details about how to use the programmable card, see the Programmable card manual.

A.6 Communication cards

A.6.1 Bluetooth communication card (EC-TX501) and WIFI communication card (EC-TX502)

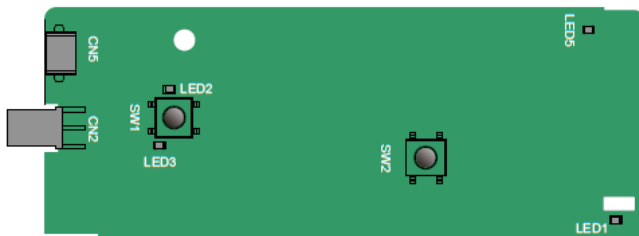

Definitions of indicators and function buttons:

Indicator No.	Definition	Function
LED1/LED3	Bluetooth/WIFI state indicator	On: The expansion card is establishing a connection with the control board. Blinks periodically: The expansion card is properly connected to the control board (the period is 1s, on for 0.5s, and off for the other 0.5s). Off: The expansion card is disconnected from the control board.
LED2	Bluetooth communication state indicator	On: Bluetooth communication is online and data exchange can be performed. Off: Bluetooth communication is not in the online state.
LED5	Power indicator	On: The control board feeds power to the Bluetooth card.
SW1	WIFI factory reset button	It is used to restore the expansion card to default values and return to the local monitoring mode.
SW2	WIFI hardware reset button	It is used to restart the expansion card.

The wireless communication card is especially useful for scenarios where you cannot directly use the keypad to operate the inverter due to the restriction of the installation space. With the Galt Electric mobile app (available on www.galtelelectric.com), you can operate the inverter in a maximum distance of 30 m. You can choose a PCB antenna or an external sucker antenna. If the inverter is located in an open space and is a molded case machine, you can use a built-in PCB antenna; and if it is a sheetmetal machine and located in a metal cabinet, you need to use an external sucker antenna.

When installing a sucker antenna, install a wireless communication card on the inverter first, and then lead the SMA connector of the sucker antenna into the inverter and screw it to CN2, as shown in the following figure. Place the antenna base on the chassis and expose the upper part. Try to keep it unblocked.

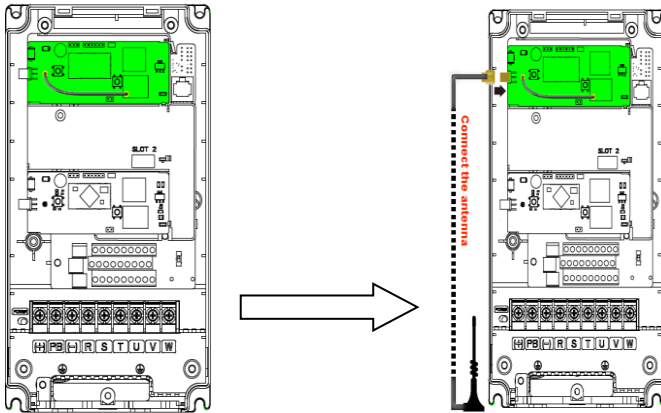

The wireless communication card must be used with the Galt Electric mobile app, available on www.galtelecric.com. For details, refer to the wireless communication card manual provided with the expansion card. The main interface is shown as follows.

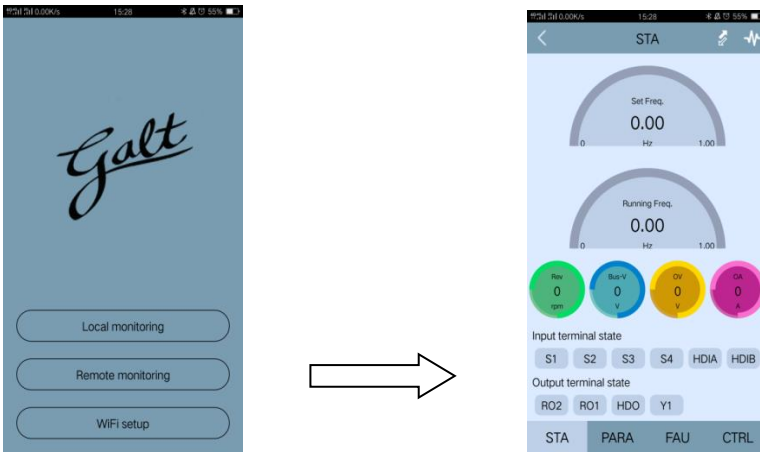

A.6.2 PROFIBUS-DP communication card (EC-TX503)

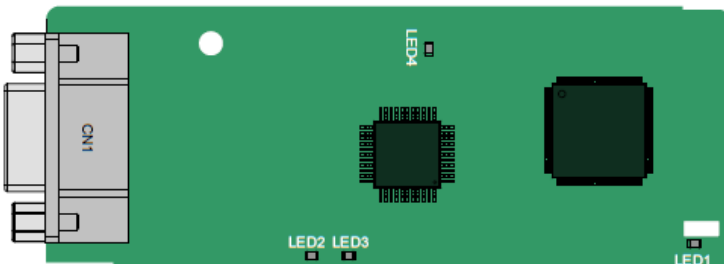

CN1 is a 9-pin D-type connector, as shown in the following figure.

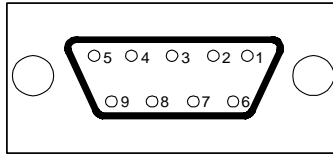

Connector pin		Description
1	-	Unused
2	-	Unused
3	B-Line	Data+ (twisted pair 1)
4	RTS	Request transmission
5	GND_BUS	Isolation ground
6	+5V_BUS	Isolated power supply of 5 V DC
7	-	Unused
8	A-Line	Data- (twisted pair 2)
9	-	Unused
Housing	SHLD	PROFIBUS cable shielding line

+5V and GND_BUS are bus terminators. Some devices, such as the optical transceiver (RS485), may need to obtain power through these pins.

On some devices, the transmission and receiving directions are determined by RTS. In normal applications, only A-Line, B-Line, and the shield layer need to be used.

Indicator definition

Indicator No.	Definition	Function
LED1	State indicator	On: The expansion card is establishing a connection with the control board. Blinks periodically: The expansion card is properly connected to the control board (the period is 1s, on for 0.5s, and off for the other 0.5s). Off: The expansion card is disconnected from the control board.
LED2	Online indicator	On: The communication card is online and data exchange can be performed. Off: The communication card is not in the online state.
LED3	Offline/Fault indicator	On: The communication card is offline and data exchange cannot be performed. Blinks: The communication card is not in the offline state. Blinks at the frequency of 1 Hz: A configuration error occurs: The length of the user parameter data set during the initialization of the communication card is different from that during the network configuration. Blinks at the frequency of 2 Hz: User parameter data is incorrect.

Indicator No.	Definition	Function
		The length or content of the user parameter data set during the initialization of the communication card is different from that during the network configuration. Blinks at the frequency of 4 Hz: An error occurs in the ASIC initialization of PROFIBUS communication. Off: The diagnosis function is disabled.
LED4	Power indicator	On: The control board feeds power to the communication card.

For details about the operation, see the *Communication Expansion card Operation Manual*.

A.6.3 Ethernet communication card (EC-TX504)

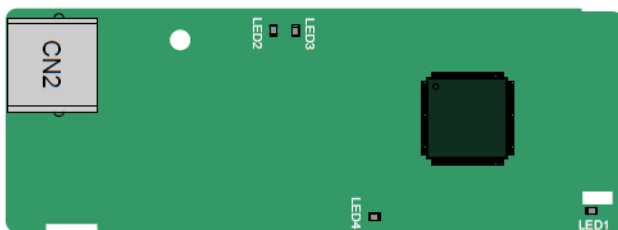

The EC-TX504 communication card adopts standard RJ45 terminals.

Indicator definition

Indicator No.	Definition	Function
LED1	State indicator	On: The expansion card is establishing a connection with the control board. Blinks periodically: The expansion card is properly connected to the control board (the period is 1s, on for 0.5s, and off for the other 0.5s). Off: The expansion card is disconnected from the control board.
LED2	Network connection status indicator	On: The physical connection to the upper computer is normal. Off: The upper computer is disconnected.
LED3	Network communication status indicator	On: There is data exchange with the upper computer. Off: There is no data exchange with the upper computer.
LED4	Power indicator	On: The control board feeds power to the communication card.

A.6.4 CAN multi-protocol communication card (EC-TX505C)

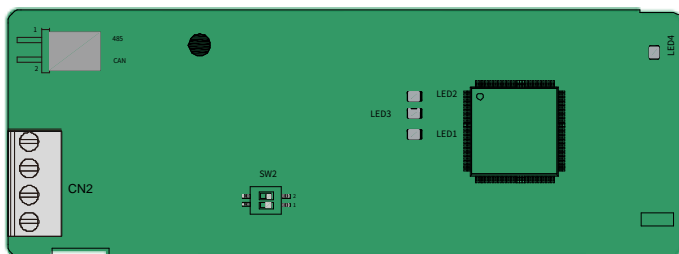

The EC-TX505C communication card is user-friendly, adopting spring terminals.

Label	Description	
PGND	Isolation ground	Isolation ground
PE	Shielded	CAN bus shielding
CANH	CANopen bus high level signal	CAN bus high level signal
CANL	CANopen bus low level signal	CAN bus low level signal
485	485 terminal resistor switch	ON: RS485+ and RS485- are connected to a terminal resistor of 120 Ω.
		OFF: RS485+ and RS485- are not connected to a terminal resistor.
CAN	CAN terminal resistor switch	ON: CAN_H and CAN_L are connected to a terminal resistor of 120 Ω.
		OFF: CAN_H and CAN_L are not connected to a terminal resistor.

Note: Before power on, please select the protocol type by setting the switch SW2 as follows:

Switch SW2		
1	2	Protocol type
OFF	OFF	CANopen
ON	OFF	CAN master/slave

Indicator definition

Indicator No.	Definition	Function
LED1	State indicator	On: The expansion card is establishing a connection with the control board. Blinks periodically: The expansion card is properly connected to the control board (the period is 1s, on for 0.5s, and off for the other 0.5s). Off: The expansion card is disconnected from the control board.
LED2	Running indicator	On: The communication card is running. Blinks: The communication card is in the pre-operation state.

Indicator No.	Definition	Function
		Off: A fault occurs. Check whether the reset pin of the communication card and the power supply are properly connected. The communication card is in the stopped state.
LED3	Error indicator	On: The CAN controller bus is off, a fault occurs on the inverter, or a received frame is missed or an error occurs during frame receiving. Off: The communication card is in the working state.
LED4	Power indicator	On: The control board feeds power to the communication card.

For details about the operation, see the *Communication Expansion card Operation Manual*.

A.6.5 PROFINET communication card (EC-TX509)

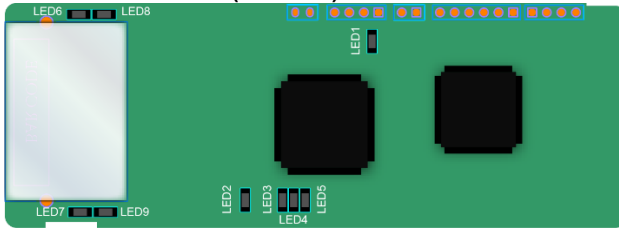

The terminal CN2 adopts a standard RJ45 interface, where CN2 is the dual RJ45 interface, and these two RJ45 interfaces are not distinguished from each other and can be interchangeably inserted. They are arranged as follows:

Pin	Name	Description
1	TX+	Transmit Data+
2	TX-	Transmit Data-
3	RX+	Receive Data+
4	n/c	Not connected
5	n/c	Not connected
6	RX-	Receive Data-
7	n/c	Not connected
8	n/c	Not connected

State indicator

The PROFINET communication card has 9 indicators, of which LED1 is the power indicator, LEDs 2–5 are the communication state indicators of the communication card, and LEDs 6–9 are the state indicators of the network port.

Indicator No.	Color	State	Description
LED1	Green		3.3V power indicator
LED2 (Bus state indicator)	Red	On	No network connection
		Blinking	The connection to the PROFINET controller through a network cable is OK, but the

Indicator No.	Color	State	Description
			communication is not established.
		Off	Communication with the PROFINET controller has been established
LED3 (System fault indicator)	Green	On	PROFINET diagnosis is enabled
		Off	PROFINET diagnosis is not enabled
LED4 (Slave ready indicator)	Green	On	TPS-1 protocol stack has started
		Blinking	TPS-1 waits for MCU initialization
		Off	TPS-1 protocol stack does not start
LED5 (Maintenance state indicator)	Green		Manufacturer-specific - depending on the characteristics of the device
LED6/7 (Network port state indicator)	Green	On	PROFINET communication card and PC/PLC have been connected through a network cable.
		Off	PROFINET communication card and PC/PLC have not been connected.
LED8/9 (Network port communication indicator)	Green	On	PROFINET communication card and PC/PLC are communicating.
		Off	PROFINET communication card and PC/PLC are not communicating.

Electrical connection:

The PROFINET communication card adopts a standard RJ45 interface and can adopt the linear network topology or star network topology. The electrical connection in linear network topology mode is shown in the following.

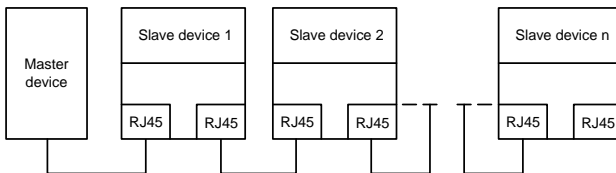

Electrical connection in linear network topology mode

Note: For the star network topology, users need to prepare PROFINET switches.

The electrical connection in start network topology mode is shown in the following.

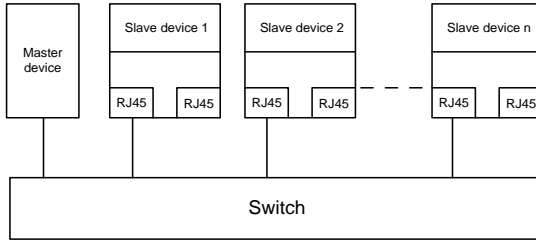

A.6.6 Ethernet/IP communication card (EC-TX510) and Modbus TCP communication card (EC-TX515)

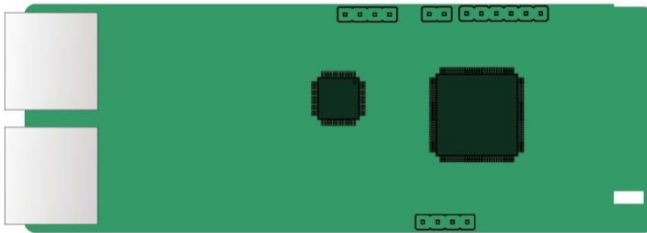

The terminal CN2 adopts standard dual RJ45 interfaces, and the two RJ45 interfaces are not distinguished from each other and can be interchangeably inserted.



Figure 9-7 Standard RJ45 interface

Standard RJ45 interface functions

Pin	Name	Description
1	TX+	Transmit Data+
2	TX-	Transmit Data-
3	RX+	Receive Data+
4	n/c	Not connected
5	n/c	Not connected
6	RX-	Receive Data-
7	n/c	Not connected
8	n/c	Not connected

State indicators

The EtherNet/IP communication card provides four LED indicators and four net port indicators to indicate its states.

Indicator No.	Color	State	Description
LED1	Green	On	The card is shaking hands with the inverter.

Indicator No.	Color	State	Description
		Blinking (1Hz)	The card and inverter communicate normally.
		Off	The card and inverter communicate improperly.
LED2	Green	On	The communication between the card and PLC is online and data interchange is allowed.
		Blinking (1Hz)	IP address conflict between the card and PLC.
		Off	The communication between the card and PLC is offline.
LED3	Red	On	Failed to set up I/O between the card and PLC.
		Blinking (1Hz)	Incorrect PLC configuration.
		Blinking (2Hz)	The card failed to send data to the PLC.
		Blinking (4Hz)	The connection between the card and PLC timed out.
		Off	No fault.
LED4	Red	On	3.3V power indicator.
Net port indicator	Yellow	On	Link indicator, indicating successful Ethernet connection.
		Off	Link indicator, indicating Ethernet connection not established.
Net port indicator	Green	On	ACK indicator, indicating data interchange being performed.
		Off	ACK indicator, indicating data interchange not be performed.

Electrical wiring

The EtherNet/IP communication card provides standard RJ45 ports and supports the linear, star, and ring topologies. The following three figures show the electrical wiring diagrams.

Use CAT5, CAT5e, and CAT6 network cables for electrical wiring. When the communication distance is greater than 50 meters, use high-quality network cables that meet the high-quality standards.

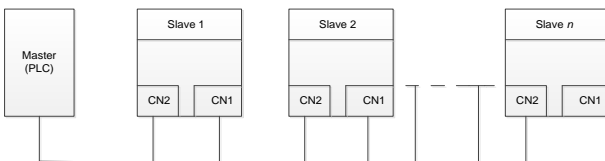

Figure 9-8 Electrical wiring diagram for a linear topology

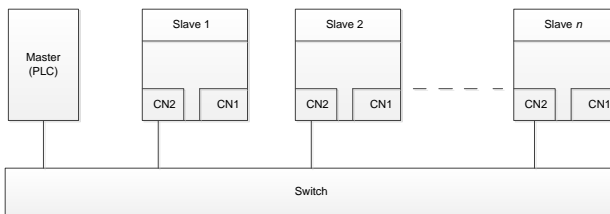

Figure 9-9 Electrical wiring diagram for a star topology

Note: Ethernet switches must be available when the star topology is used.

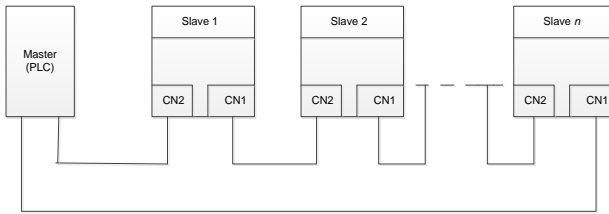
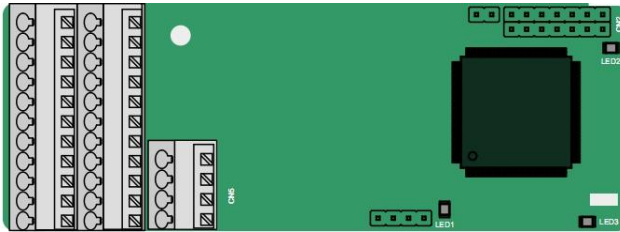

Figure 9-10 Electrical wiring diagram for a ring network

A.7 PG cards

A.7.1 Sin/Cos PG card (EC-PG502)



The terminals are arranged as follows:

							C1+	C1-	D1+	D1-
PE	AO+	BO+	ZO+	A1+	B1+	R1+	A2+	B2+	Z2+	PWR
GND	AO-	BO-	ZO-	A1-	B1-	R1-	A2-	B2-	Z2-	GND

Definitions of indicators

Indicator No.	Definition	Function
LED1	Disconnection indicator	Off: A1 and B1 of the encoder are disconnected. Blinking: C1 and D1 of the encoder are disconnected. On: The encoder signals are normal.
LED2	Power indicator	On: The control board feeds power to the PG card.
LED3	State indicator	On: The expansion card is establishing a connection with the control board. Blinking periodically: The expansion card is properly connected to the control board (the period is 1s, on for 0.5s, and off for the other 0.5s). Off: The expansion card is disconnected from the control board.

EC-PG502 terminal function description

Label	Name	Function description
PWR	Encoder power	Voltage: 5 V ± 5%
PGND		Max. output current: 150 mA

Label	Name	Function description
A1+	Encoder interface	1. Supporting Sin/Cos encoders 2. SINA/SINB/SINC/SIND 0.6–1.2Vpp; SINR 0.2–0.85Vpp 3. Max. frequency response of A/B signals: 200 kHz Max. frequency response of C/D signals: 1 kHz
A1-		
B1+		
B1-		
R1+		
R1-		
C1+		
C1-		
D1+	Pulse reference	1. Supporting interfaces whose signal type is the same as the encoder 2. Frequency response: 200 kHz
D1-		
A2+		
A2-		
B2+		
B2-		
Z2+	Frequency-divided output	1. Differential output of 5 V 2. Supporting frequency division of 2^N , which can be set through P20.16 or P24.16 3. Max. output frequency: 200 kHz
Z2-		
AO+		
AO-		
BO+		
BO-		
ZO+		
ZO-		

The following figure shows the external wiring of the PG card when it is used in combination with an encoder without CD signals.

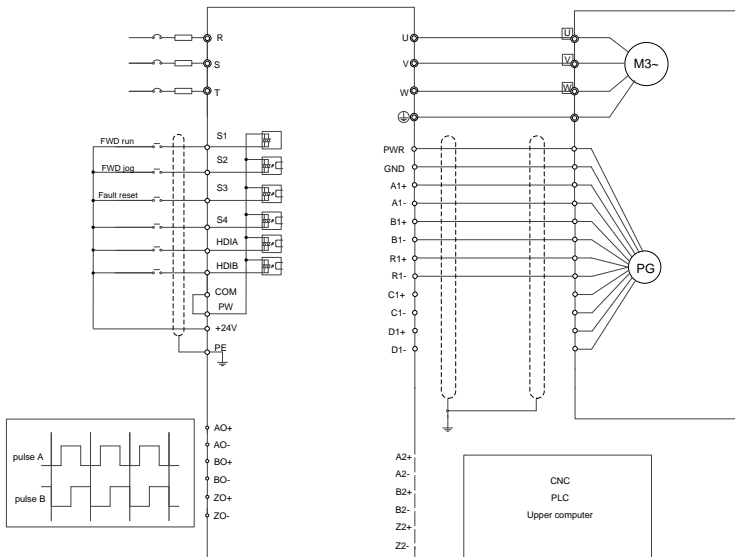

The following figure shows the external wiring of the PG card when it is used in combination with an encoder with CD signals.

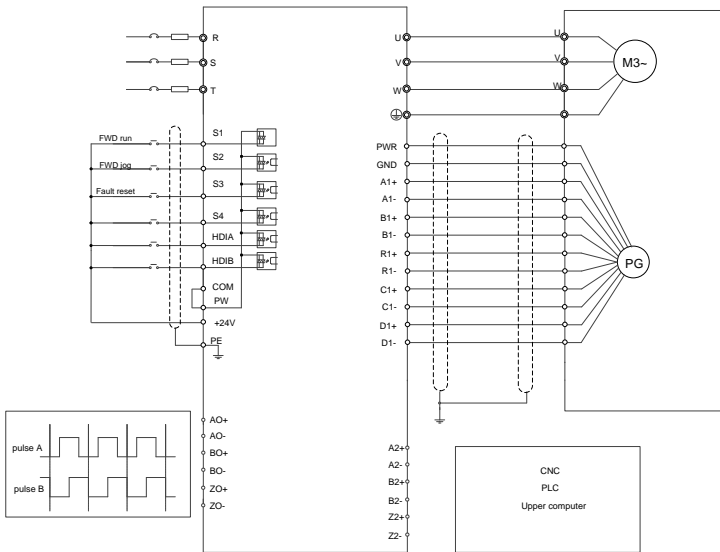

A.7.2 UVW incremental PG card (EC-PG503-05)

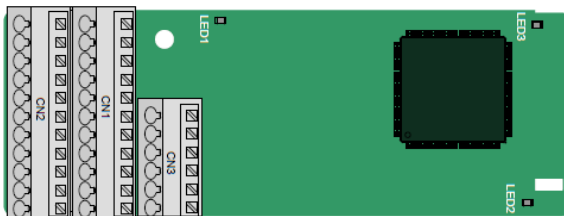

The terminals are arranged as follows:

					A2+	A2-	B2+	B2-	Z2+	Z2-
PE	AO+	BO+	ZO+	A1+	B1+	Z1+	U+	V+	W+	PWR
GND	AO-	BO-	ZO-	A1-	B1-	Z1-	U-	V-	W-	PGND

Indicator definition

Indicator No.	Definition	Function
LED1	Disconnection indicator	This indicator blinks only if A1 or B1 signal is disconnected during encoder rotating; and it is on in other cases.
LED2	State indicator	On: The expansion card is establishing a connection with the control board. Blinking periodically: The expansion card is properly connected to the control board (the period is 1s, on for 0.5s,

Indicator No.	Definition	Function
		and off for the other 0.5s). Off: The expansion card is disconnected from the control board.
LED3	Power indicator	On: The control board feeds power to the PG card.

The EC-PG503-05 expansion card supports the input of absolute position signals and integrates the advantages of absolute and incremental encoders. It is user-friendly, adopting spring terminals.

EC-PG503-05 terminal function description

Label	Name	Function description
PWR	Encoder power	Voltage: 5 V±5%
PGND		Max. current: 200 mA
A1+	Encoder interface	1. Differential incremental PG interface of 5 V 2. Response frequency: 400 kHz
A1-		
B1+		
B1-		
Z1+		
Z1-		
A2+	Pulse setting	1. Differential input of 5 V 2. Response frequency: 200 kHz
A2-		
B2+		
B2-		
Z2+		
Z2-		
AO+	Frequency-divided output	1. Differential output of 5 V 2. Supporting frequency division of 1–255, which can be set through P20.16 or P24.16
AO-		
BO+		
BO-		
ZO+		
ZO-		
U+	UVW encoder interface	1. Absolute position (UVW information) of the hybrid encoder, differential input of 5 V 2. Response frequency: 40 kHz
U-		
V+		
V-		
W+		
W-		

The following figure shows the external wiring of the EC-PG503-05 expansion card.

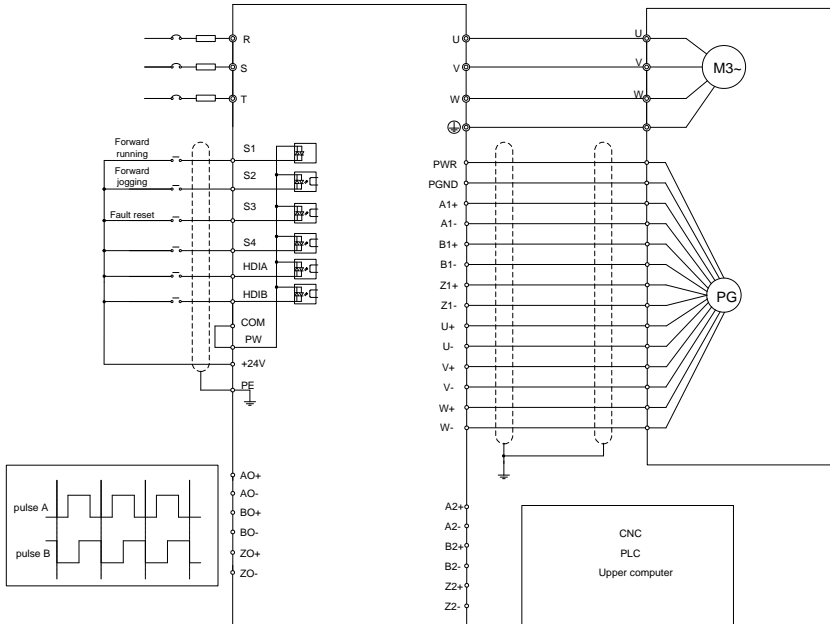

A.7.3 Resolver PG card (EC-PG504-00)

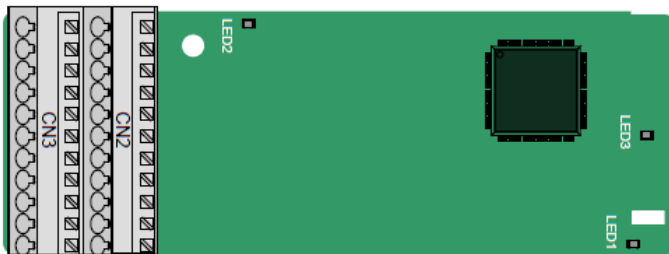

PE	AO+	BO+	ZO+	EX+	SI+	CO+	A2+	B2+	Z2+	PWR
GND	AO-	BO-	ZO-	EX-	SI-	CO-	A2-	B2-	Z2-	GND

Indicator definition

Indicator No.	Definition	Function
LED1	State indicator	On: The expansion card is establishing a connection with the control board. Blinks periodically: The expansion card is properly connected to the control board (the period is 1s, on for 0.5s, and off for the other 0.5s).

Indicator No.	Definition	Function
		Off: The expansion card is disconnected from the control board.
LED2	Disconnection indicator	Off: The encoder is disconnected. On: The encoder signals are normal. Blinks: The encoder signals are not stable.
LED3	Power indicator	On: The control board feeds power to the PG card.

The EC-PG504-00 expansion card can be used in combination with a resolver of excitation voltage 7 Vrms. It is user-friendly, adopting spring terminals.

EC-PG504-00 terminal function description

Label	Name	Function description
SI+	Encoder signal input	Recommended resolver transformation ratio: 0.5
SI-		
CO+		
CO-		
EX+	Encoder excitation signal	1. Factory setting of excitation: 10 kHz
EX-		2. Supporting resolvers with an excitation voltage of 7 Vrms
A2+	Pulse setting	1. Differential input of 5 V 2. Response frequency: 200 kHz
A2-		
B2+		
B2-		
Z2+		
Z2-		
AO+	Frequency-divided output	1. Differential output of 5 V 2. Frequency-divided output of resolver simulated A1, B1, and Z1, which is equal to an incremental PG card of 1024 pps. 3. Supporting frequency division of 1–255, which can be set through P20.16 or P24.16 4. Max. output frequency: 200 kHz
AO-		
BO+		
BO-		
ZO+		
ZO-		

The following figure shows the external wiring of the EC-PG504-00 expansion card.

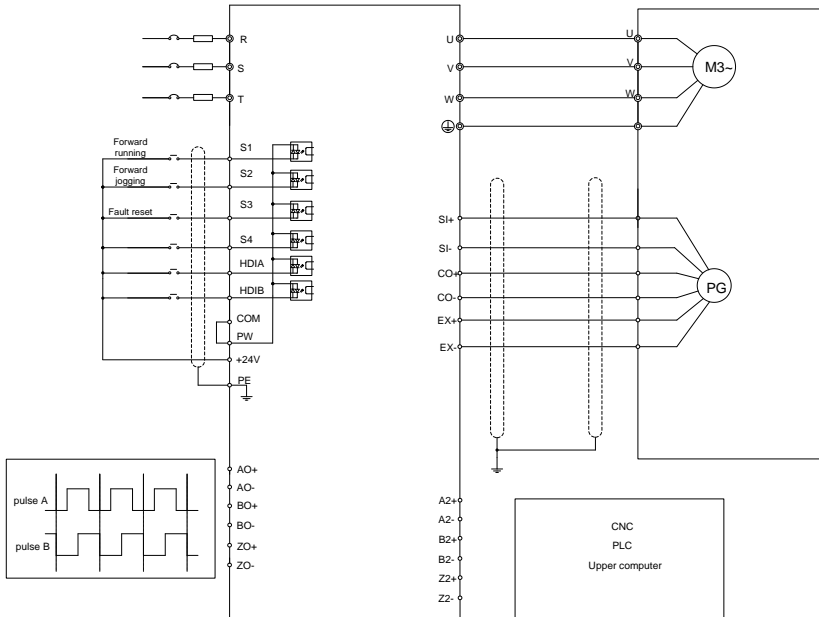

A.7.4 Multi-function incremental PG card (EC-PG505-12)

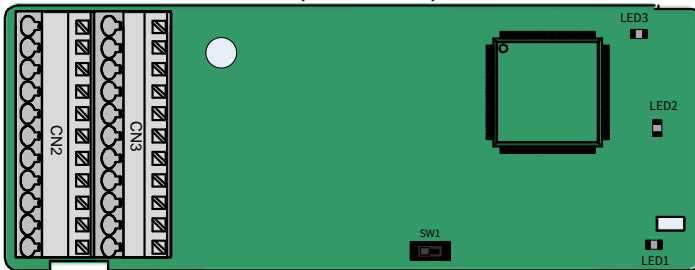

The terminals are arranged as follows:

The switch SW1 is used to set the voltage class (5 V or 12 V) of the power supply of the encoder. The switch can be operated with an auxiliary tool.

PE	AO+	BO+	ZO+	A1+	B1+	Z1+	A2+	B2+	Z2+	PWR
GND	AO-	BO-	ZO-	A1-	B1-	Z1-	A2-	B2-	Z2-	PGND

Indicator definition

Indicator No.	Definition	Function
LED1	State indicator	On: The expansion card is establishing a connection with the control board. Blinks periodically: The expansion card is properly connected to the control board (the period is 1s, on for 0.5s, and off for the other 0.5s). Off: The expansion card is disconnected from the control board.
LED2	Disconnection indicator	Off: A1 and B1 of the encoder are disconnected. On: The pulses are normal.
LED3	Power indicator	On: The control board feeds power to the PG card.

The EC-PG505-12 expansion card can be used in combination with multiple types of incremental encoders through different modes of wiring. It is user-friendly, adopting spring terminals.

EC-PG505-12 terminal function description

Label	Name	Function description
PWR	Encoder power	Voltage: 5 V/12 V \pm 5% Max. output: 150 mA Select the voltage class through the switch SW1 based on the voltage class of the used encoder.
PGND		
A1+	Encoder interface	1. Supporting push-pull interfaces of 5 V/12 V 2. Supporting open collector interfaces of 5 V/12 V 3. Supporting differential interfaces of 5 V 4. Response frequency: 400 kHz
A1-		
B1+		
B1-		
Z1+		
Z1-		
A2+	Pulse setting	1. Supporting the same signal types as the encoder signal types 2. Response frequency: 400 kHz
A2-		
B2+		
B2-		
Z2+		
Z2-		
AO+	Frequency-divided output	1. Differential output of 5 V 2. Supporting frequency division of 1–255, which can be set through P20.16 or P24.16
AO-		
BO+		
BO-		
ZO+		
ZO-		

The following figure shows the external wiring of the expansion card used in combination with an open collector encoder. A pull-up resistor is configured inside the PG card.

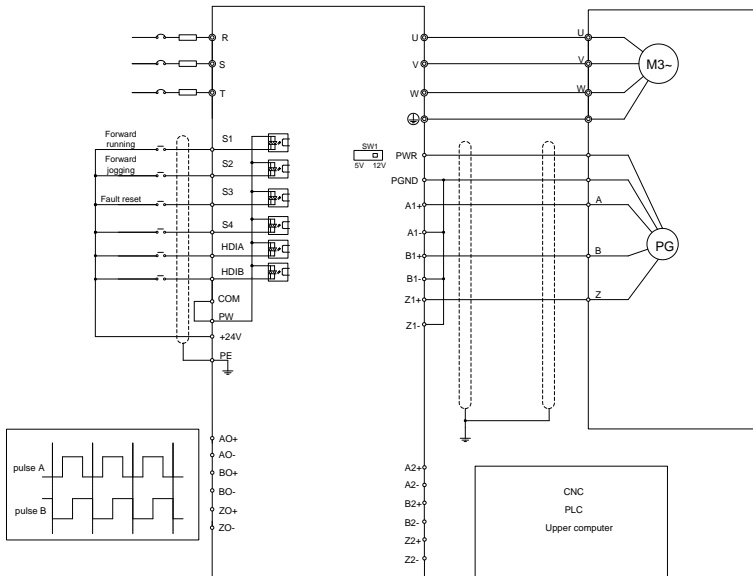

The following figure shows the external wiring of the expansion card used in combination with a push-pull encoder.

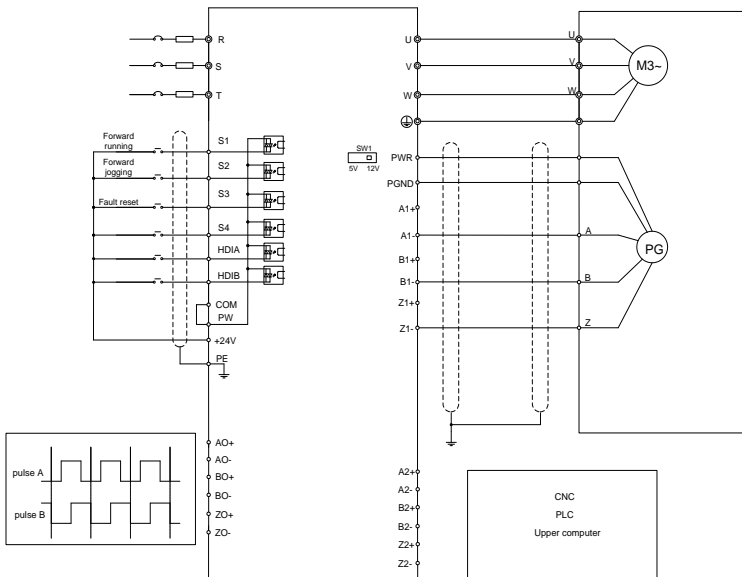

The following figure shows the external wiring of the expansion card used in combination with a differential encoder.

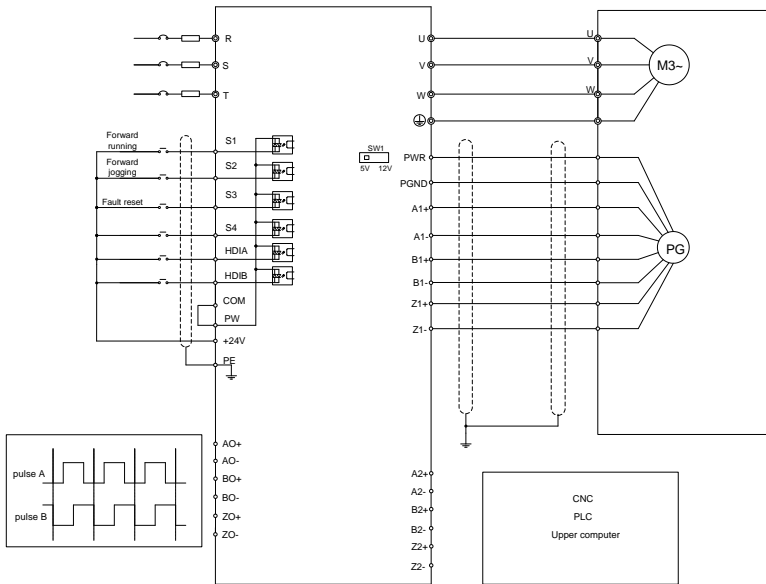

A.7.5 24 V multi-function incremental PG card (EC-PG505-24B)

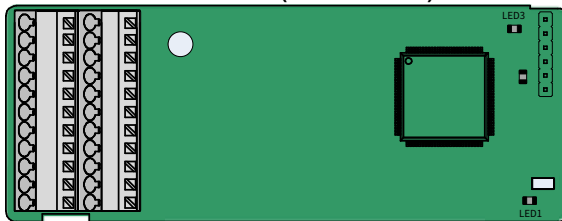

The terminals are arranged as follows:

PE	AO+	BO+	ZO+	A1+	B1+	Z1+	A2+	B2+	Z2+	PWR
GND				A1-	B1-	Z1-	A2-	B2-	Z2-	PGND

Indicator definition

Indicator No.	Definition	Function
LED1	State indicator	On: The expansion card is establishing a connection with the control board. Blinks periodically: The expansion card is properly connected to the control board (the period is 1s, on for 0.5s, and off for the other 0.5s). Off: The expansion card is disconnected from the control board.

Indicator No.	Definition	Function
LED2	Disconnection indicator	Off: A1 and B1 of the encoder are disconnected. On: The encoder pulses are normal. Blinks: An exception occurs in the communication between the encoder and control board.
LED3	Power indicator	On: The control board feeds power to the PG card.

EC-PG505-24B can work in combination with multiple types of incremental encoders through various external wiring modes. AO-, BO-, and ZO- are short connected to PGND internally. It is user-friendly, adopting spring terminals.

EC-PG505-24B terminal function description

Signal	Port	Description
PWR	Encoder power supply	Voltage: 24 V \pm 5%
PGND		Max. output current: 150 mA
A1+	Encoder interface	<ol style="list-style-type: none"> Supporting 24 V push-pull interfaces Supporting 24 V open collector interfaces Supporting 24V differential interfaces Frequency response: 400 kHz
A1-		
B1+		
B1-		
Z1+		
Z1-		
A2+	Pulse reference	<ol style="list-style-type: none"> Supporting 24V push-pull, OC interfaces Supporting 5V differential input interface Frequency response: 400 kHz
A2-		
B2+		
B2-		
Z2+		
Z2-		
AO+	Frequency-divided output	<ol style="list-style-type: none"> Supporting open collector output. The input is externally connected with the upper resistor. Supporting frequency division of 1–255, which can be set through P20.16 or P24.16. Supporting frequency division output source, which can be set through P20.17 or P24.17.
BO+		
ZO+		

The following figure shows the external wiring of the PG card when it is used in combination with an open-drain collector encoder. A pull-up resistor is configured in the PG card.

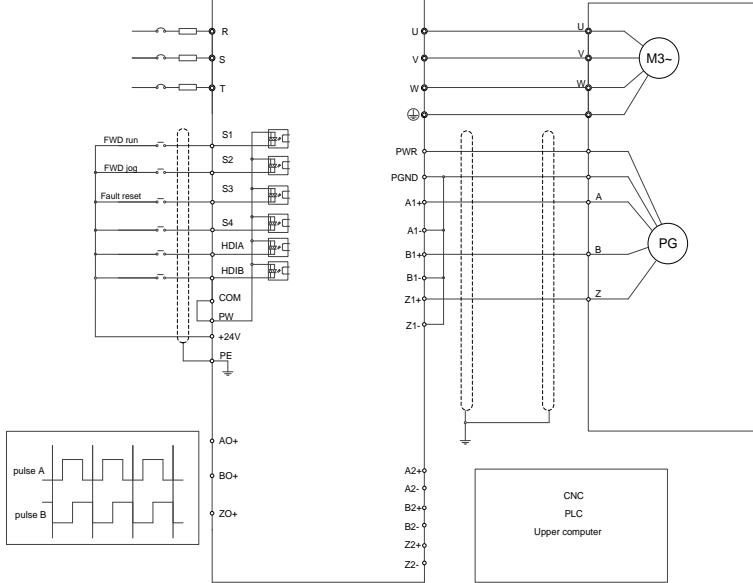

The following figure shows the external wiring of the PG card when it is used in combination with a push-pull encoder.

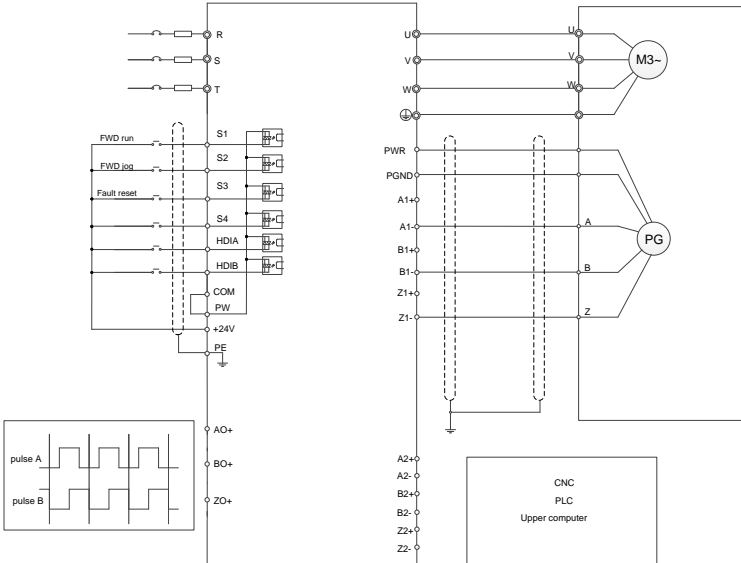

A.7.6 Simple incremental PG card (EC-PG507-12)

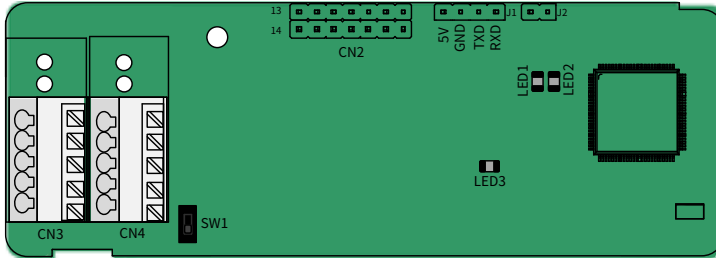

The terminals are arranged as follows:

The switch SW1 is used to set the voltage class (5 V or 12 V) of the power supply of the encoder. The switch can be operated with an auxiliary tool.

PE	A1+	B1+	Z1+	PWR
PGND	A1-	B1-	Z1-	PGND

Indicator definition

Indicator No.	Definition	Function
LED1	State indicator	On: The expansion card is establishing a connection with the control board. Blinks periodically: The expansion card is properly connected to the control board (the period is 1s, on for 0.5s, and off for the other 0.5s). Off: The expansion card is disconnected from the control board.
LED2	Disconnection indicator	Off: A1 and B1 of the encoder are disconnected. On: The encoder pulses are normal.
LED3	Power indicator	On: The control board feeds power to the PG card.

The EC-PG507-12 expansion card can be used in combination with multiple types of incremental encoders through different modes of wiring. The wiring modes are the same as those for EC-PG505-12.

EC-PG507-12 terminal function description

Label	Name	Function description
PWR	Encoder power supply	Voltage: 5 V/12 V $\pm 5\%$ Max. output: 150 mA
PGND		Select the voltage class through the switch SW1 based on the voltage class of the used encoder.
A1+	Encoder interface	1. Supporting push-pull interfaces of 5 V/12 V
A1-		2. Supporting open collector interfaces of 5 V/12 V
B1+		3. Supporting differential interfaces of 5 V

Label	Name	Function description
B1-		4. Response frequency: 200 kHz
Z1+		5. Supporting encoder cables at a maximum length of 50m
Z1-		

A.7.7 24V simplified incremental PG card (EC-PG507-24)

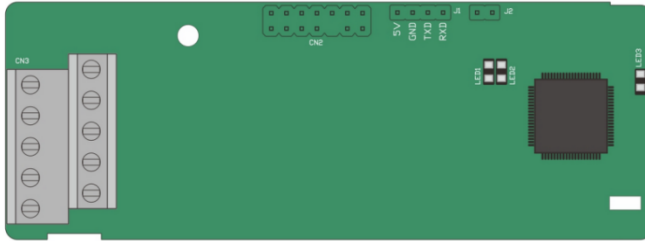

The terminals are arranged as follows:

PE	A1+	B1+	Z1+	PWR
PGND	A1-	B1-	Z1-	PGND

Indicator definition

Indicator	Name	Description
LED1	State indicator	This indicator is on when the expansion card is establishing a connection with the control board; it blinks periodically after the expansion card is properly connected to the control board (the period is 1s, on for 0.5s, and off for the other 0.5s); and it is off when the expansion card is disconnected from the control board.
LED2	Disconnection indicator	Off: A1 or B1 of the encoder is disconnected. On: The encoder pulses are normal.
LED3	Power indicator	This indicator is on after the control board feeds power to the PG card.

EC-PG507-24 can work in combination with multiple types of incremental encoders through various external wiring modes. It is easy to use for the use of 5.08mm pitch terminal.

EC-PG507-24 terminal function description

Signal	Port	Description
PE	Grounding terminal	Connected to the ground to enhance anti-interference performance.
PWR	Encoder power	Voltage: 24V±5%; Max. output current: 150mA (PGND is the ground for power isolation)
PGND		
A1+	Encoder interface	1. Supporting push-pull interfaces of 24 V 2. Supporting open collector interfaces of 24 V 3. Supporting differential interfaces of 24 V
A1-		
B1+		

Signal	Port	Description
B1-		4. Frequency response: 200 kHz 5. Supporting the encoder cable length of up to 100 m
Z1+		
Z1-		

The following figure shows the external wiring of the PG card when it is used in combination with an open collector encoder. A pull-up resistor is configured in the PG card.

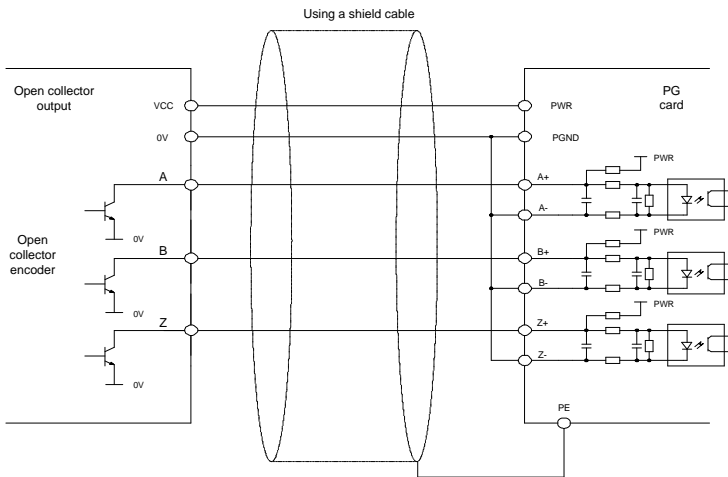
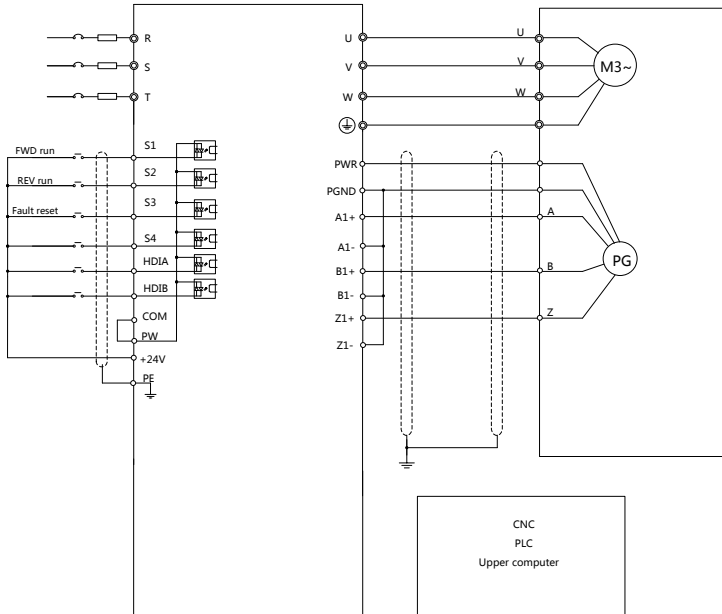

The following figure shows the external wiring of the PG card when it is used in combination with a push-pull encoder.

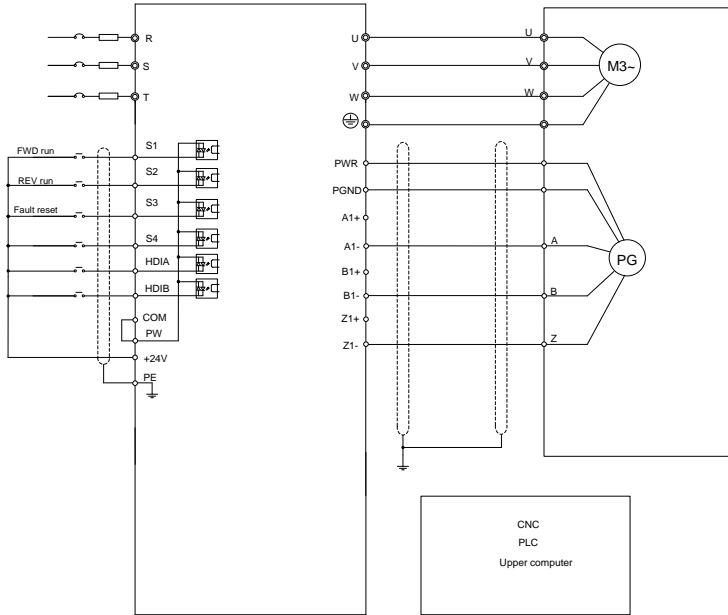

Using a shield cable

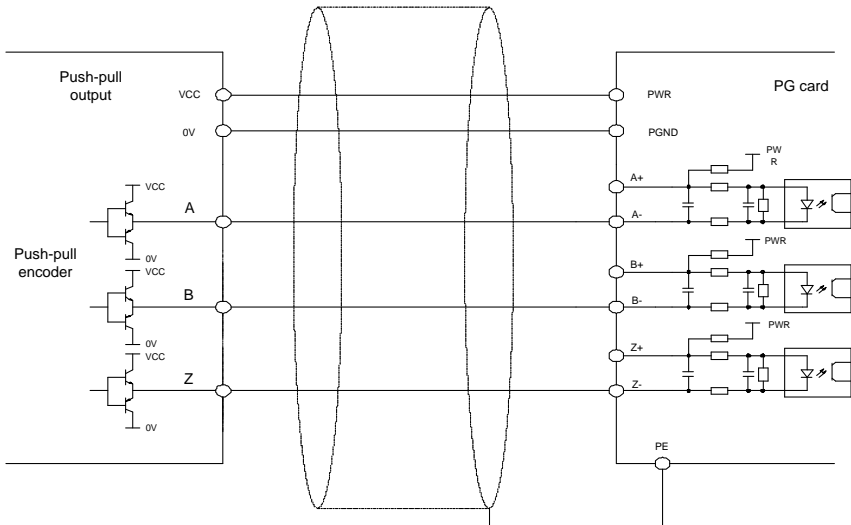

The following figure shows the external wiring of the PG card when it is used in combination with a differential encoder.

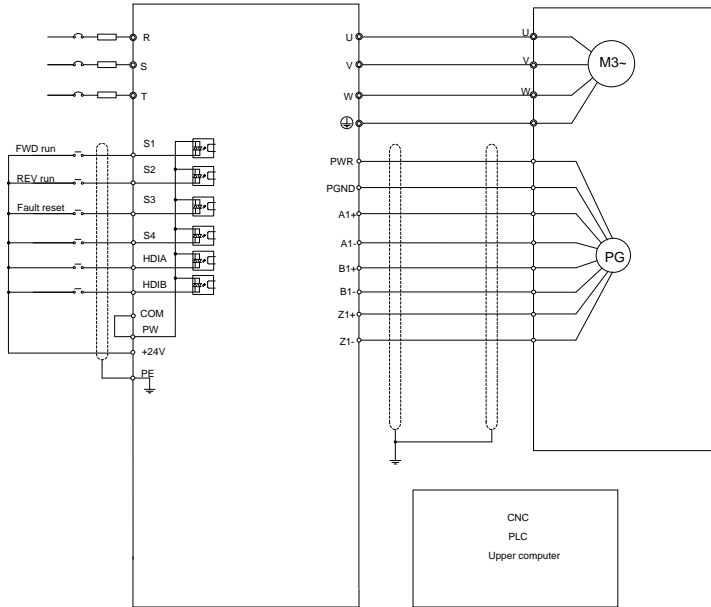

Using a shield cable

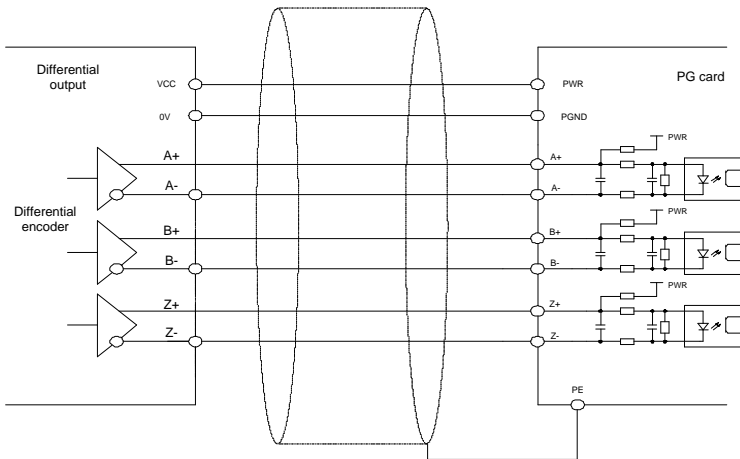

A.8 IoT cards

A.8.1 GPRS card (EC-IC501-2)

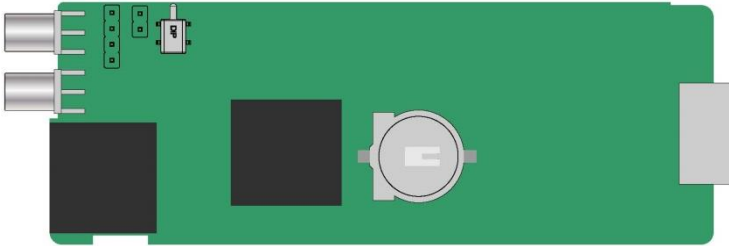

CN6 pin definition

Pin	Name	Description
1	485-	485B
2	485+	485A
3	GND	Power ground
4	24V	24V power

State indicator definition

The GPRS IoT card has five state indicators.

Indicator	Name	Function
LED1	Handshaking indicator	It blinks at a frequency of 1s when the card normally connects to the control board.
LED2	Power indicator	It is on upon power on.
LED3	Run indicator	The card communicates normally.
LED4	GPRS state indicator	When GPRS connects to the network, it blinks fast at a specific interval (with 64ms on and 300ms off); when GPRS does not connect to the network, it blinks slowly at a specific interval (with 64ms on and 800ms off).
LED5	State indicator	It is always on when the GPRS module is powered on.

Note: For details, see the EC series GPRS expansion card manual.

A.8.2 4G card (EC-IC502-2-CN, EC-IC502-2-EU, EC-IC502-2-LA)

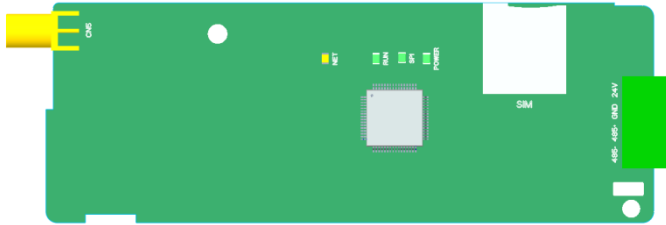

Terminal definition

Terminal	Description
24V	Power supply +
GND	Power supply -
485+	485A
485-	485B
4G	4G antenna
CN3	SIM card tray

Indicator definition

Indicator	Description
NET	Network indicator Blinking slowly (On: 600ms; Off: 600ms): No SIM card/Network registration in progress/Registration failed. Blinking fast (On: 75ms; Off: 75ms): Data link established.
RUN	Running indicator Blinking (On: 1s; Off: 1s): The system runs properly. On or Off: System exceptions happened.
SPI	Handshaking indicator Blinking (On: 1s; Off: 1s): Handshaking between the expansion card and inverter control board is successful. On: Handshaking failed or no handshaking.
POWER	Power supply indicator

Note: For details about the operation, see the EC Series 4G Expansion Card Operation Manual.

Appendix B Technical data

B.1 What this chapter contains

This chapter describes the technical data of the inverter and its compliance to CE and other quality certification systems.

Note: Unless otherwise specified, the power described in this chapter refers to the ND power. For example, 0.75–55kW (1–75HP) described in this chapter refers to the ND power.

B.2 Derated application

B.2.1 Capacity

Choose an inverter based on the rated current and power of the motor. To endure the rated power of the motor, the rated output current of the inverter must be larger or equal to the rated current of the motor. The rated power of the inverter must be higher or equal to that of the motor.

Note:

1. The maximum allowable shaft power of the motor is limited to 1.5 times the rated power of the motor. If the limit is exceeded, the inverter automatically restricts the torque and current of the motor. This function effectively protects the input shaft against overload.
2. The rated capacity is the capacity at the ambient temperature of 40°C.
3. You need to check and ensure that the power flowing through the common DC connection in the common DC system does not exceed the rated power of the motor.

B.2.2 Derating

The load capacity decreases if the installation site ambient temperature exceeds 40°C, the altitude exceeds 1000 meters or the switching frequency is changed from 4 kHz to 8, 12 or 15 kHz.

B.2.2.1 Temperature derating

When the temperature ranges from +40°C to +50°C, the rated output current is derated by 1% for each increased 1°C. Refer to the below list for the actual derating.

Power (HP)	Temperature and derating coefficient										
	40°0	41°1	42°2	43°3	44°4	45°5	46°6	47°7	48°8	49°9	50°0
2	100%	100%	100%	100%	100%	100%	99%	98%	97%	96%	95%
3	100%	99%	98%	97%	96%	95%	94%	93%	92%	91%	90%
5	100%	100%	100%	100%	100%	100%	99%	98%	97%	96%	95%
7.5	100%	99%	98%	97%	96%	95%	94%	93%	92%	91%	90%
10	100%	100%	100%	100%	100%	100%	99%	98%	97%	96%	95%
15	100%	99%	98%	97%	96%	95%	94%	93%	92%	91%	90%
20	100%	100%	100%	100%	100%	100%	99%	98%	97%	96%	95%
25	100%	99%	98%	97%	96%	95%	94%	93%	92%	91%	90%
30	100%	100%	100%	100%	100%	100%	99%	98%	97%	96%	95%
40	100%	99%	98%	97%	96%	95%	94%	93%	92%	91%	90%
50	100%	100%	100%	100%	100%	100%	99%	98%	97%	96%	95%

Power (HP)	Temperature and derating coefficient										
	40°0	41°1	42°2	43°3	44°4	45°5	46°6	47°7	48°8	49°9	50°0
60	100%	100%	100%	99%	98%	97%	96%	95%	94%	93%	92%
75	100%	99%	98%	97%	96%	95%	94%	93%	92%	91%	90%

Below is the derating curve of the big-power inverters:

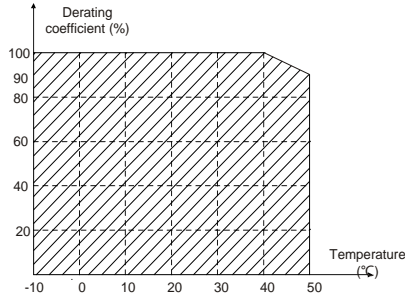

B.2.2.2 Altitude derating

When the altitude of the site where the inverter is installed is lower than 1000m, the inverter can run at the rated power. When the altitude exceeds 1000m, derate 1% for every additional 100m. When the installation site altitude exceeds 3000m, consult the local dealer or office.

B.2.2.3 Carrier frequency derating

For G500 series inverters, different power level corresponds to different carrier frequency range. The rated power of the inverter is based on the factory carrier frequency, so if it is above the factory value, the inverter needs to derate.

Power (HP)	Carrier frequency and derating coefficient													
	2kHz	3kHz	4kHz	5kHz	6kHz	7kHz	8kHz	9kHz	10kHz	11kHz	12kHz	13kHz	14kHz	15kHz
2	100%	100%	100%	100%	100%	100%	100%	100%	96%	93%	90%	87%	85%	83%
3	100%	100%	100%	100%	100%	100%	100%	98%	95%	92%	89%	86%	83%	81%
5	100%	100%	100%	100%	100%	100%	100%	100%	96%	92%	89%	86%	83%	80%
7.5	100%	100%	100%	100%	100%	100%	100%	97%	93%	90%	87%	84%	81%	79%
10	100%	100%	100%	100%	100%	100%	100%	100%	95%	91%	87%	84%	81%	79%
15	100%	100%	100%	100%	100%	100%	100%	96%	92%	88%	84%	80%	77%	74%
20	100%	100%	100%	100%	95%	91%	87%	83%	79%	75%	71%	/	/	/
25	100%	100%	100%	96%	92%	88%	84%	81%	77%	74%	70%	/	/	/
30	100%	100%	100%	100%	100%	94%	87%	80%	74%	68%	64%	/	/	/
40	100%	100%	100%	95%	90%	80%	75%	70%	66%	62%	58%	/	/	/
50	100%	100%	100%	100%	100%	95%	90%	86%	82%	78%	74%	/	/	/
60	100%	100%	100%	100%	95%	90%	85%	81%	77%	73%	69%	/	/	/
75	100%	100%	100%	96%	91%	86%	81%	77%	73%	69%	65%	/	/	/

B.3 Grid specifications

Grid voltage	AC 3PH 380V–480V
Allowable voltage fluctuation	-15%–10%
Frequency	50/60 Hz±5%, with a maximum change rate of 20%/s

B.4 Motor connection data

Motor type	Asynchronous induction motor or permanent-magnet synchronous motor
Voltage	0–U ₁ (rated voltage of the motor), 3PH symmetrical, U _{max} (rated voltage of the inverter) at the field-weakening point
Short-circuit protection	The short-circuit protection for the motor output meets the requirements of IEC 61800-5-1.
Frequency	0–400 Hz
Frequency resolution	0.01 Hz
Current	See the rated current.
Power limit	1.5 times of the rated power of the motor
Carrier frequency	4, 8, 12, or 15 kHz

B.4.1 EMC compatibility and motor cable length

The following table describes the maximum motor cable lengths that meet the requirements of the EU EMC directive (2004/108/EC) when the carrier frequency is 4 kHz.

All models (with external EMC filters)	Maximum motor cable length (m)
Environment category II (C3)	30

You can learn the maximum length of the motor cable through the running parameters of the inverter. To understand the accurate maximum cable length for using an external EMC filter, contact the local distributor or company office.

For description about the environments categories I (C2) and II (C3), see Section B.6 "EMC regulations".

B.5 Application standards

The following table describes the standards that the inverters comply with.

EN/ISO 13849-1	Safety of machinery—Safety-related parts of control systems—Part 1: General principles for design
IEC/EN 60204-1	Safety of machinery—Electrical equipment of machines. Part 1: General requirements
IEC/EN 62061	Safety of machinery—Safety-related functional safety of electrical, electronic, and programmable electronic control systems
IEC/EN 61800-3	Adjustable speed electrical power drive systems—Part 3: EMC requirements and specific test methods
IEC/EN 61800-5-1	Adjustable speed electrical power drive systems—Part 5-1: Safety

	requirements—Electrical, thermal and energy
IEC/EN 61800-5-2	Adjustable speed electrical power drive systems—Part 5-2: Safety requirements—Function
C22.2 No. 274-13	Adjustable-speed drives, 1st edition.
UL 508C	Power conversion equipment, 3 rd edition
GB/T 30844.1	General-purpose variable-frequency adjustable-speed equipment of 1 kV and lower—Part 1: Technical conditions
GB/T 30844.2	General-purpose variable-frequency adjustable-speed equipment of 1 kV and lower—Part 2: Test methods
GB/T 30844.3	General-purpose variable-frequency adjustable-speed equipment of 1 kV and lower—Part 3: Safety regulations

B.5.1 CE marking

The CE marking on the name plate of an inverter indicates that the inverter is CE-compliant, meeting the regulations of the European low-voltage directive (2014/35/EU) and EMC directive (2014/30/EU).

B.5.2 UL and CUL marking

The UL and CUL markings are attached to the inverter, indicating that the inverter follows the provisions of UL508C and C22.2 No. 274-13.

B.5.3 EMC compliance declaration

European union (EU) stipulates that the electric and electrical devices sold in Europe cannot generate electromagnetic disturbance that exceeds the limits stipulated in related standards, and can work properly in environments with certain electromagnetic interference. The EMC product standard (EN 61800-3) describes the EMC standards and specific test methods for adjustable speed electrical power drive systems. Products must strictly follow these EMC regulations.

B.6 EMC regulations

The EMC product standard (EN 61800-3) describes the EMC requirements on inverters.

Application environment categories

Category I: Civilian environments, including application scenarios where inverters are directly connected to the civil power supply low-voltage grids without intermediate transformers

Category II: All environments except those in Category I.

Inverter categories

C1: Rated voltage lower than 1000 V, applied to environments of Category I.

C2: Rated voltage lower than 1000 V, non-plug, socket, or mobile devices; power drive systems that must be installed and operated by specialized personnel when applied to environments of Category I

Note: The EMC standard IEC/EN 61800-3 no longer restricts the power distribution of inverters, but it specifies their use, installation, and commissioning. Specialized personnel or organizations must have the necessary skills (including the EMC-related knowledge) for installing and/or performing commissioning on the electrical drive systems.

C3: Rated voltage lower than 1000 V, applied to environments of Category II. They cannot be applied to environments of Category I.

C4: Rated voltage higher than 1000 V, or rated current higher or equal to 400 A, applied to complex systems in environments of Category II.

B.6.1 Inverter category of C2

The induction disturbance limit meets the following stipulations:

1. Select an optional EMC filter according to Appendix D and install it following the description in the EMC filter manual.
2. Select the motor and control cables according to the description in the manual.
3. Install the inverter according to the description in the manual.
4. For the maximum length of the motor cable when the switching frequency is 4 kHz, see Section B.4.1 "EMC compatibility and motor cable length".



The inverter may generate radio interference; user should take measures to reduce the interference.

B.6.2 Inverter category of C3

The anti-interference performance of the inverter meets the requirements of environments Category II in the IEC/EN 61800-3 standard.

The induction disturbance limit meets the following stipulations:

1. Select an optional EMC filter according to Appendix D and install it following the description in the EMC filter manual.
2. Select the motor and control cables according to the description in the manual.
3. Install the inverter according to the description in the manual.
4. For the maximum length of the motor cable when the switching frequency is 4 kHz, see Section B.4.1 "EMC compatibility and motor cable length".



Inverters of C3 category cannot be applied to civilian low-voltage common grids. When applied to such grids, the inverter may generate radio frequency electromagnetic interference.

Appendix C Dimension drawings

C.1 What this chapter contains

This chapter describes the dimension drawings of G500 series inverters. The dimension unit used in the drawings is mm.

Note: Unless otherwise specified, the power described in this chapter refers to the ND power. For example, 0.75–55kW (1–75HP) described in this chapter refers to the ND power.

C.2 Keypad structure

C.2.1 Structure diagram

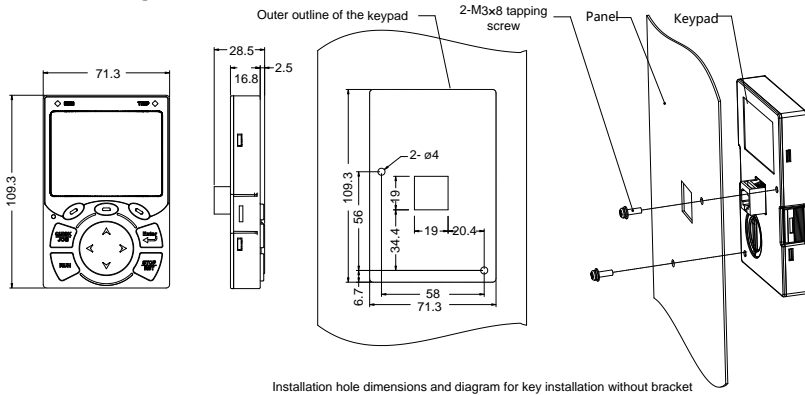

Figure C-1 Keypad structure diagram

C.2.2 Keypad installation bracket

Note: When installing a keypad in a position away from the inverter, you can directly use M3 threaded screws or a keypad bracket. For inverters of 220V, 0.75kW/1HP to 15kW/20HP and 460V, 1.5kW/2HP to 30kW/40HP, you need to use optional keypad installation brackets. For those of 220V, 18.5kW/25HP to 55kW/75HP, 460V, 37kW/50HP to 500kW/675HP, and 575V, 18.5kW/25HP to 110kW/150HP, you can use optional brackets or use the standard keypad brackets externally.

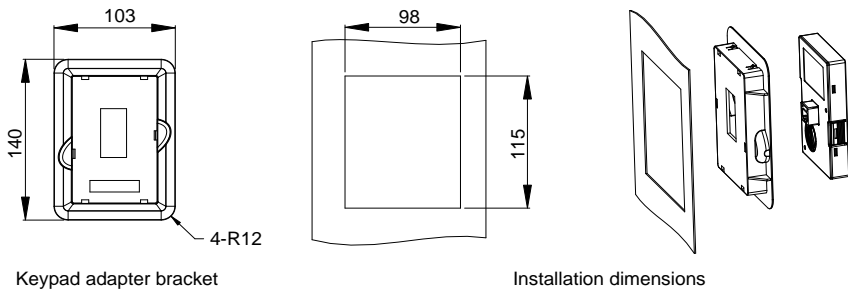

Figure C-2 Keypad installation bracket

C.3 Inverter structure

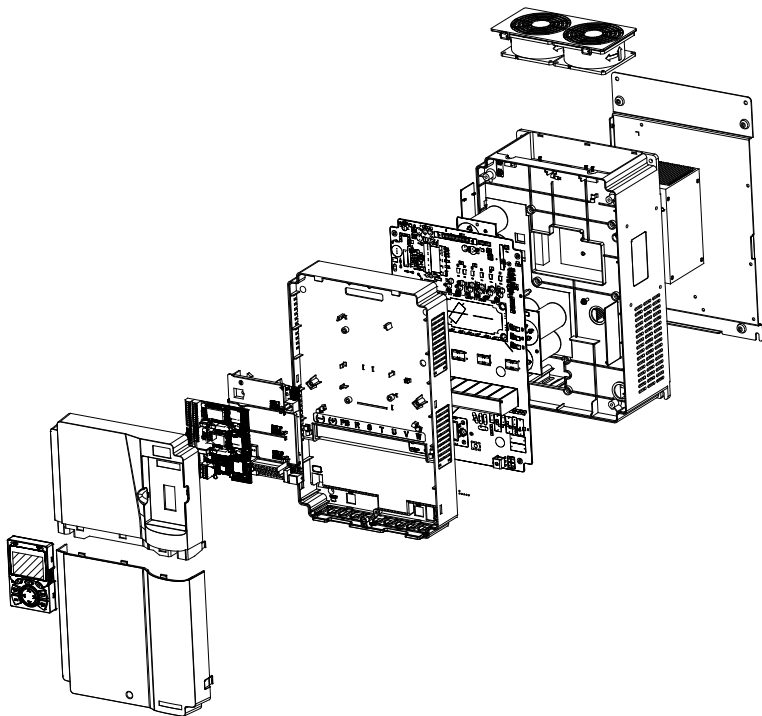

Figure C-3 Inverter structure diagram

C.4 Dimensions of Inverters of AC 3PH 200V–240V and 380V–440V

C.4.1 Wall-mounting dimensions

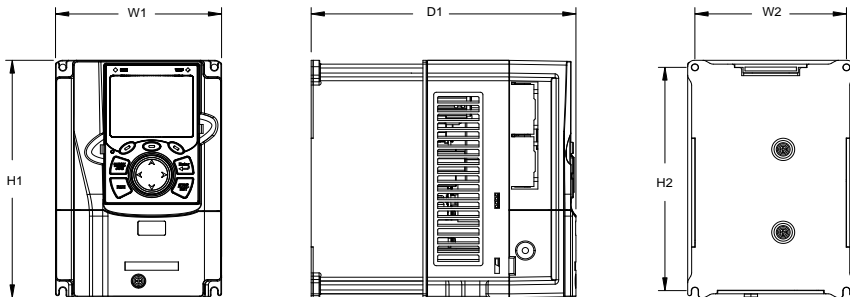

Figure C-4 Wall-mounting diagram of inverters of 220V 0.75–15kW (1–20HP) and 460V 1.5–37kW (2–25HP)

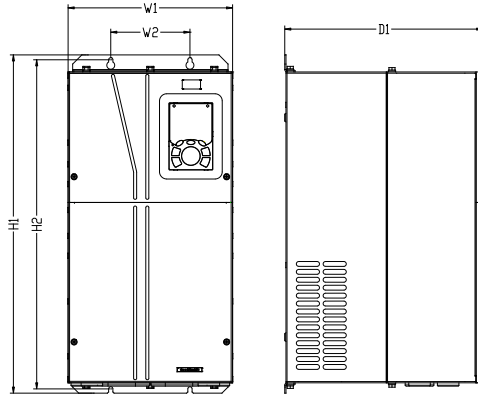

Figure C-5 Wall-mounting diagram of inverters of 220V 18.5–55kW (25–75HP) and 460V 37–55kW (50–75HP)

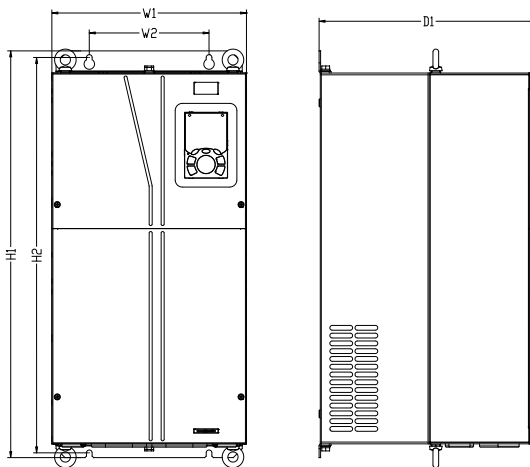

Figure C-6 Wall-mounting diagram of inverters of 460V 75-110kW (100–150HP)

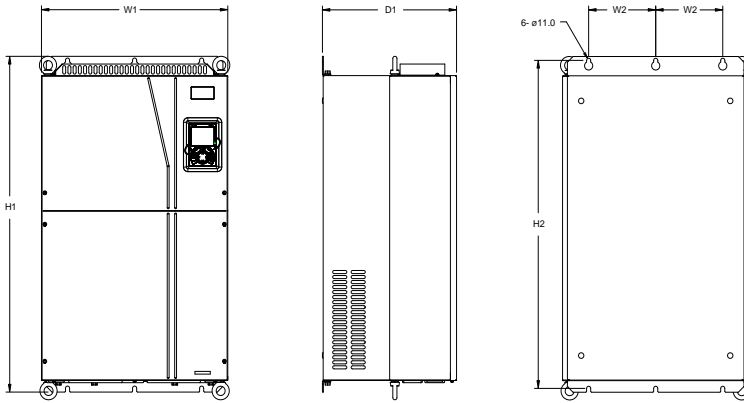

Figure C-7 Wall-mounting diagram of inverters of 460V 132–200kW (175–270HP)

Table C-1 Wall-mounting dimensions of 220V 0.75–55kW (1–75HP) (unit: mm)

Model	W1	W2	H1	H2	D1	Installation hole
G520-00045UL-XX	126	115	186	175	185	5
G520-00070UL-XX– G520-00100UL-XX	146	131	256	243.5	192	5
G520-00160UL-XX– G520-00200UL-XX	170	151	320	303.5	219	6
G520-00300UL-XX	230	210	330	311	217	6
G520-00420UL-XX– G520-00550UL-XX	255	237	400	384	242	7
G520-00700UL-XX– G520-01100UL-XX	270	130	555	540	325	7
G520-01300UL-XX– G520-02000UL-XX	325	200	680	661	365	9.5

Table C-2 Wall-mounting dimensions of 460V inverters (unit: mm)

Model	W1	W2	W3	H1	H2	D1	Installation hole
G540-00037UL-XX– G540-00050UL-XX	126	115	-	186	175	185	5
G540-00140UL-XX– G540-00185UL-XX	146	131	-	256	243.5	192	5
G540-00250UL-XX– G540-00320UL-XX	170	151	-	320	303.5	219	6
G540-00380UL-XX– G540-00450UL-XX	230	210	-	330	311	217	6

Model	W1	W2	W3	H1	H2	D1	Installation hole
G540-00600UL-XX– G540-00750UL-XX	255	237	-	400	384	242	7
G540-00920UL-XX– G540-01150UL-XX	270	130	-	555	540	325	7
G540-01500UL-XX– G540-02150UL-XX	325	200	-	680	661	365	9.5
G540-02600UL-XX– G540-04250UL-XX	500	180	-	870	850	360	11

C.4.2 Flange installation dimensions

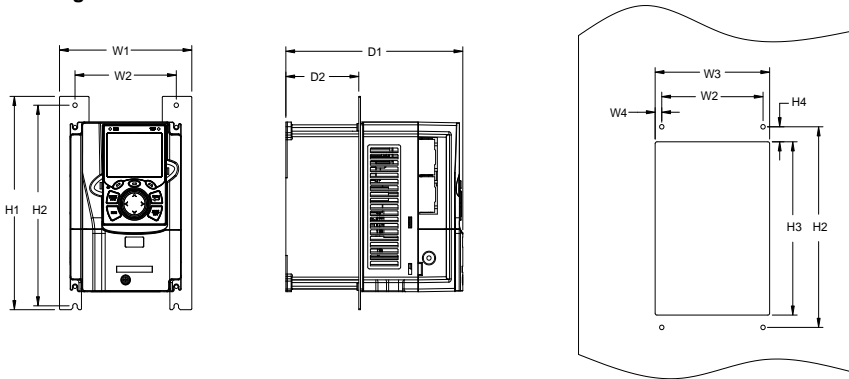

Figure C-8 Flange installation diagram of inverters of 220V 0.75–15kW (1–20HP) and 460V 1.5–30kW (2–40HP)

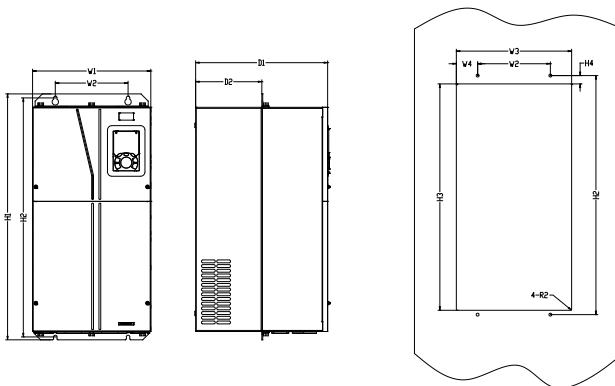

Figure C-9 Flange installation diagram of inverters of 220V 18.5–55kW (25–75HP) and 460V 75–110kW (100–150HP)

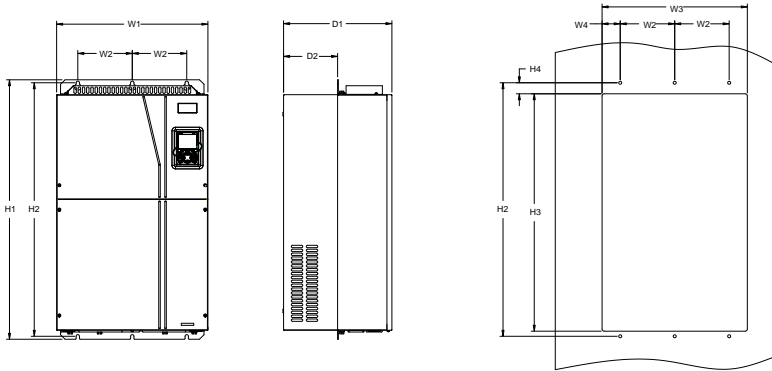

Figure C-10 Flange installation diagram of inverters of 460 V 132–200kW (175–270HP)

Table C-3 Flange installation dimensions of 220V 0.75–55kW (1–75HP)

Model	W1	W2	W3	W4	H1	H2	H3	H4	D1	D2	Installation hole
G520-00045UL-XX	150	115	130	7.5	234	220	190	16.5	185	65.5	5
G520-00070UL-XX– G520-00100UL-XX	170	131	150	9.5	292	276	260	10	192	79.5	6
G520-00160UL-XX– G520-00200UL-XX	191	151	174	11.5	370	351	324	15	219	113	6
G520-00300UL-XX	250	210	234	12	375	356	334	10	217	108	6
G520-00420UL-XX– G520-00550UL-XX	275	237	259	11	445	426	404	10	242	119	7
G520-00700UL-XX– G520-01100UL-XX	270	130	261	65.5	555	540	516	17	325	167	7
G520-01300UL-XX– G520-02000UL-XX	325	200	317	58.5	680	661	626	23	363	182	9.5

Table C-4 Flange installation dimensions of 460 V inverters (unit: mm)

Model	W1	W2	W3	W4	H1	H2	H3	H4	D1	D2	Installation hole
G540-00037UL-XX– G540-00050UL-XX	150.2	115	130	7.5	234	220	190	13.5	185	65.5	5
G540-00140UL-XX– G540-00185UL-XX	170.2	131	150	9.5	292	276	260	10	192	78	5
G540-00250UL-XX– G540-00320UL-XX	191.2	151	174	11.5	370	351	324	15	219	113	6
G540-00380UL-XX– G540-00450UL-XX	250.2	210	234	12	375	356	334	10	217	108	6

Model	W1	W2	W3	W4	H1	H2	H3	H4	D1	D2	Installation hole
G540-00600UL-XX- G540-00750UL-XX	275.2	237	259	11.5	445	426	404	10	242	118	6
G540-00920UL-XX- G540-01150UL-XX	270	130	261	65.5	555	540	516	17	325	167	7
G540-01500UL-XX- G540-02150UL-XX	325	200	317	58.5	680	661	626	23	363	182	9.5
G540-02600UL-XX- G540-04250UL-XX	500	180	480	60	870	850	796	37	358	178.5	11

C.4.3 Floor installation dimensions

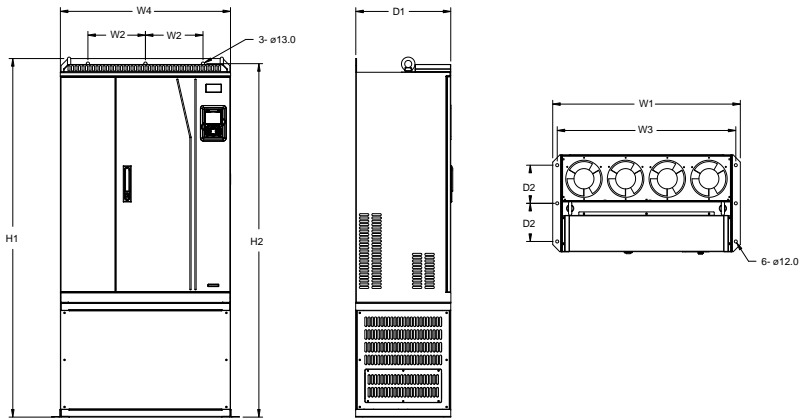

Figure C-11 Floor installation diagram of inverters of 460 V 220 to 315kW (300–425HP)

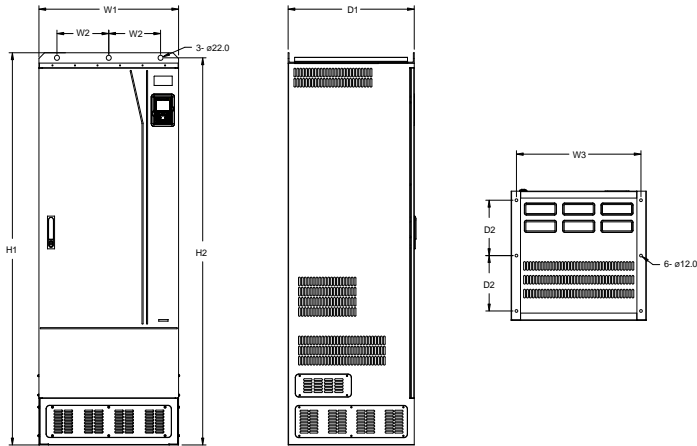

Figure C-12 Floor installation diagram of inverters of 460 V 350 to 500kW (475–675HP)

Table C-5 Floor installation dimensions of 460 V inverters (unit: mm)

Model	W1	W2	W3	W4	H1	H2	D1	D2	Installation hole
G540-04800UL-XX– G540-06500UL-XX	750	230	714	680	1410	1390	380	150	13\12
G540-07200UL-XX– G540-08600HDUL-XX	620	230	572	-	1700	1678	560	240	22\12

C.5 Dimensions of Inverters of AC 3PH 520V–600V

C.5.1 Wall-mounting dimensions

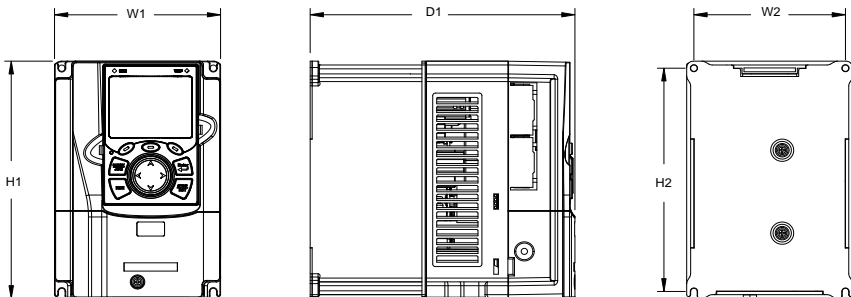

Figure C-13 Wall-mounting diagram of inverters of 575V 0.75–18.5kW (1–25HP)

Table C-6 Wall-mounting dimensions of inverters of 575V 18.5kW (1–25HP) (unit: mm)

Model	W1	W2	W3	H1	H2	D1	Installation hole
G560-00021UL-XX–	146	131	-	256	243.5	192	Ø 5

Model	W1	W2	W3	H1	H2	D1	Installation hole
G560-00045UL-XX							
G560-00065UL-XX– G560-00120UL-XX	170	151	-	320	303.5	219	Ø 6
G560-00160UL-XX– G560-00270UL-XX	230	210	-	330	311	217	Ø 6

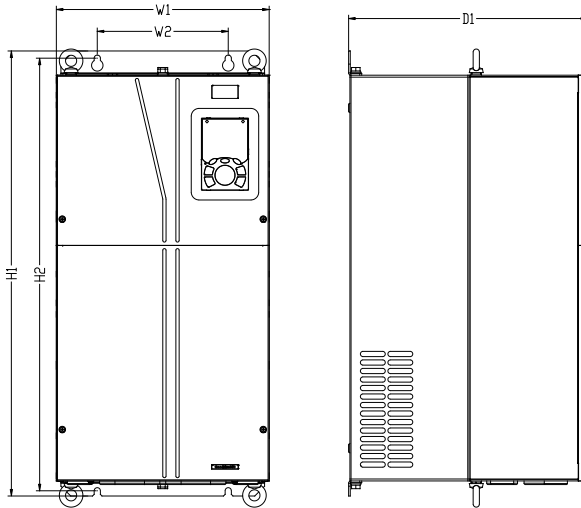

Figure C-14 Wall-mounting diagram of inverters of 575V 22kW to110kW (30–150HP)

Table C-7 Wall-mounting dimensions of inverters of 575V 22kW to110kW (30 –150HP) (unit: mm)

Model	W1	W2	H1	H2	D1	Installation hole
G560-00350UL-XX– G560-00520UL-XX	270	130	555	540	325	7
G560-00620UL-XX– G560-01500UL-XX	325	200	680	661	365	9.5

C.5.2 Flange installation dimensions

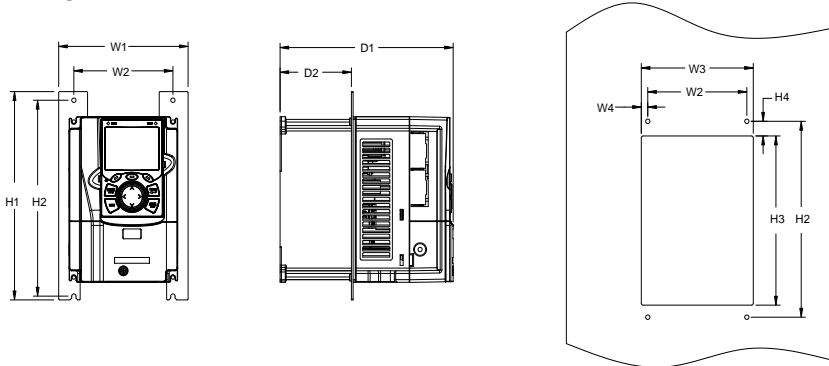

Figure C-15 Flange installation diagram of inverters of 575 V 0.75–18.5kW (1–25HP)

Table C-8 Flange installation dimensions of inverters of 575 V 0.75–18.5kW (1–25HP) (unit: mm)

Model	W1	W2	W3	W4	H1	H2	H3	H4	D1	D2	Installation hole
G560-00021UL-XX– G560-00045UL-XX	170.2	131	150	9.5	292	276	260	10	192	78	Ø 5
G560-00065UL-XX– G560-00120UL-XX	191.2	151	174	11.5	370	351	324	15	219	113	Ø 6
G560-00160UL-XX– G560-00270UL-XX	250.2	210	234	12	375	356	334	10	217	108	Ø 6

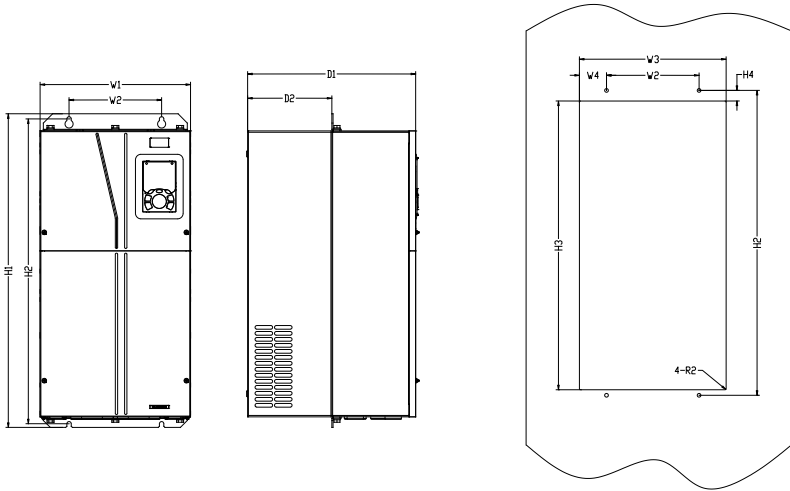

Figure C-16 Flange installation diagram of inverters of 575 V 22kW to110kW (30–150HP)

Table C-9 Flange installation dimensions of inverters of 575 V 22kW to110kW (30–150HP) (unit: mm)

Model	W1	W2	W3	W4	H1	H2	H3	H4	D1	D2	Installation hole
G560-00350UL-XX– G560-00520UL-XX	270	130	261	65.5	555	540	516	17	325	167	7
G560-00620UL-XX– G560-01500UL-XX	325	200	317	58.5	680	661	626	23	363	182	9.5

Appendix D Optional peripheral accessories

D.1 What this chapter contains

This chapter describes how to select optional accessories of G500 series inverters.





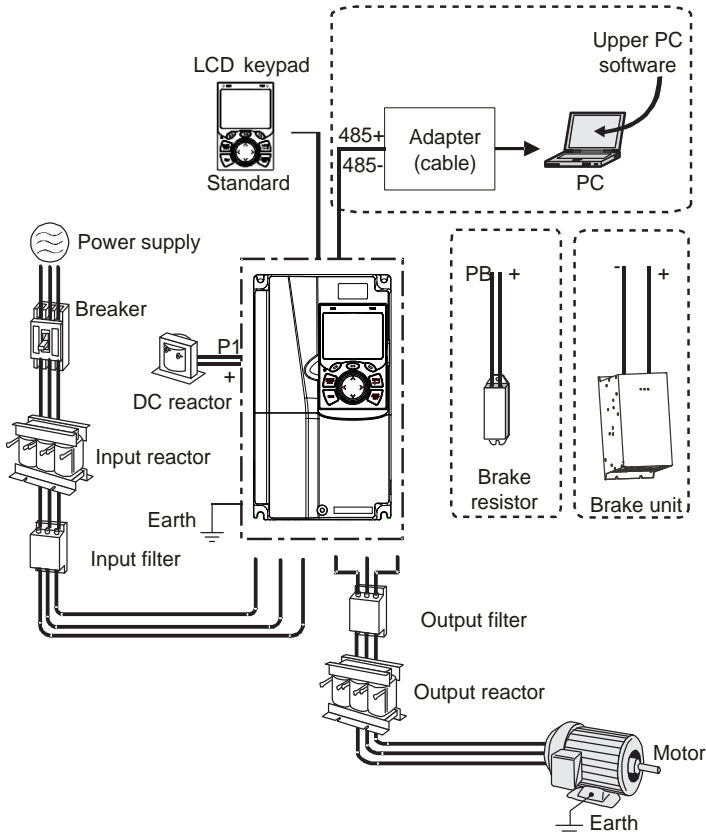

D.2 Wiring of peripheral accessories

The following figure shows the external wiring of a G500 series inverter.

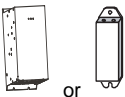

Note:

1. The inverters of 220V ($\leq 15\text{kW}/20\text{HP}$), 460V ($\leq 30\text{kW}/40\text{HP}$), and 575V ($\leq 18.5\text{kW}/25\text{HP}$) are configured with built-in brake units.
2. The inverters of 220V ($18.5\text{kW}/25\text{HP}$ – $55\text{kW}/75\text{HP}$), 460V ($\geq 37\text{kW}/50\text{HP}$), and 575V ($\geq 22\text{kW}/30\text{HP}$) are configured with P1 terminals and are connected to external DC reactors.
3. The brake units are the standard brake units. For details, see the DBU operation manual.

Image	Name	Description
	Cable	Accessory for signal transmission
	Breaker	Device for electric shock prevention and protection against short-to-ground that may cause current leakage and fire. Select residual-current circuit breakers (RCCBs) that are applicable to inverters and can restrict high-order harmonics, and of which the rated sensitive current for one inverter is larger than 30 mA.
	Input reactor	Accessories used to improve the current adjustment coefficient on the input side of the inverter, and thus restrict high-order harmonic currents.
	DC reactor	The inverters of 220V (18.5kW/25HP–55kW/75HP), 460V (≥ 37 kW/50HP) and 575V (≥ 22 kW/30HP) can be connected to external DC reactors.
	Input filter	Accessory that restricts the electromagnetic interference generated by the inverter and transmitted to the public grid through the power cable. Try to install the input filter near the input terminal side of the inverter.
	Brake unit or brake resistor	Accessories used to consume the regenerative energy of the motor to reduce the deceleration time. The inverters of 220V (≤ 15 kW/20HP), 460V (≤ 30 kW/40HP), and 575V (≤ 18.5 kW/25HP) need only brake resistors and the inverters of 220V (18.5kW/25HP–55kW/75HP), 460V (≥ 37 kW/50HP) and 575V (≥ 22 kW/30HP) need brake units.
	Output filter	Accessory used to restrict interference generated in the wiring area on the output side of the inverter. Try to install the output filter near the output terminal side of the inverter.
	Output reactor	Accessory used to lengthen the valid transmission distance of the inverter, which effectively restrict the transient high voltage generated during the switch-on and switch-off of the IGBT module of the inverter.

D.3 Power supply

Refer to the electrical installation.

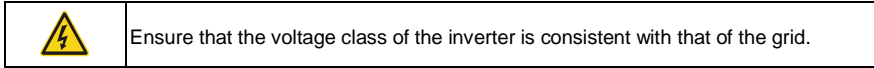

D.4 Cables

D.4.1 Power cables

The sizes of the input power cables and motor cables must meet the local regulation.

- The input power cables and motor cables must be able to carry the corresponding load currents.
- The maximum temperature margin of the motor cables in continuous operation cannot be lower than 70°C.
- The conductivity of the PE grounding conductor is the same as that of the phase conductor, that is, the cross-sectional areas are the same.
- For details about the EMC requirements, see Appendix B "Technical data".

To meet the EMC requirements stipulated in the CE standards, you must use symmetrical shielded cables as motor cables (as shown in the following figure).

Four-core cables can be used as input cables, but symmetrical shielded cables are recommended. Compared with four-core cables, symmetrical shielded cables can reduce electromagnetic radiation as well as the current and loss of the motor cables.

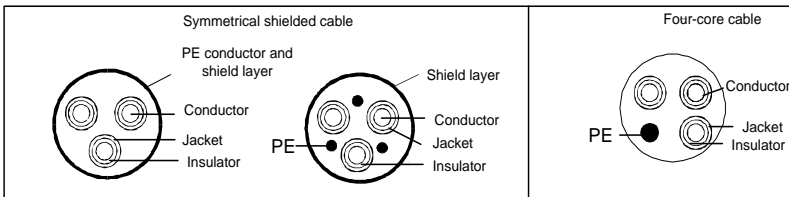

Note: If the conductivity of the shield layer of the motor cables cannot meet the requirements, separate PE conductors must be used.

To protect the conductors, the cross-sectional area of the shielded cables must be the same as that of the phase conductors if the cable and conductor are made of materials of the same type. This reduces grounding resistance, and thus improves impedance continuity.

To effectively restrict the emission and conduction of radio frequency (RF) interference, the conductivity of the shielded cable must at least be 1/10 of the conductivity of the phase conductor. This requirement can be well met by a copper or aluminium shield layer. The following figure shows the minimum requirement on motor cables of an inverter. The cable must consist of a layer of spiral-shaped copper strips. The denser the shield layer is, the more effectively the electromagnetic interference is restricted.

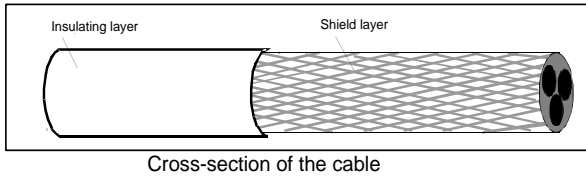

D.4.2 Control cables

All analog control cables and cables used for frequency input must be shielded cables. Analog signal cables need to be double-shielded twisted-pair cables (as shown in figure a). Use one separate shielded twisted pair for each signal. Do not use the same ground wire for different analog signals.

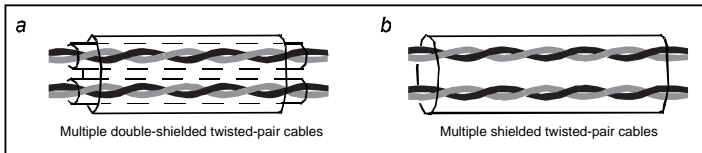

For low-voltage digital signals, double-shielded cables are recommended, but shielded or unshielded twisted pairs (as shown in figure b) also can be used. For frequency signals, however, only shielded cables can be used.

Relay cables need to be those with metal braided shield layers.

Keypads need to be connected by using network cables. In complicated electromagnetic environments, shielded network cables are recommended.

Note: Analog signals and digital signals cannot use the same cables, and their cables must be arranged separately.

Do not perform any voltage endurance or insulation resistance tests, such as high-voltage insulation tests or using a megameter to measure the insulation resistance, on the inverter or its components. Insulation and voltage endurance tests have been performed between the main circuit and chassis of each inverter before delivery. In addition, voltage limiting circuits that can automatically cut off the test voltage are configured inside the inverters.

Note: Check the insulation conditions of the input power cable of an inverter according to the local regulations before connecting it.

Model number	Recommended cable size (AWG)		Required torque (in-lbs)		Wire connector (##)
	R, S, T; U, V, W; P1, (+), PB, (-)	PE	R, S, T; U, V, W; P1, (+), PB, (-)	PE	
G520-00045UL-XX	14	12	11	10	Optional
G520-00070UL-XX	8	12	11	10	Required
G520-00100UL-XX	8	12	11	10	Required
G520-00160UL-XX	8	10	20 or 25 @@	15	Optional
G520-00200UL-XX	8	10	20 or 25 @@	15	Optional
G520-00300UL-XX	6	15	20	8	Required
G520-00420UL-XX	3	8	25.5	18	Required
G520-00550UL-XX	3	6	25.5	18	Required
G520-00700UL-XX	2/0	6	25.5	75	Required
G520-00800UL-XX	2/0	6	25.5	75	Required
G520-01100UL-XX	2/0	6	25.5	75	Required
G520-01300UL-XX	2/0AWG	1AWG	60 or 80 \$\$	10	Required
G520-01600UL-XX	1/0 AWG x 2	1AWG	90	10	Required
G520-02000UL-XX	1/0 AWG x 2	1AWG	90	10	Required
G540-00037UL-XX	14AWG	12AWG	11	10	Optional
G540-00050UL-XX	14AWG	12AWG	11	10	Optional
G540-00140UL-XX	8AWG	12AWG	11	10	Required
G540-00185UL-XX	8AWG	10AWG	11	10	Required
G540-00250UL-XX	8AWG	10AWG	20 or 25 @@	15	Optional
G540-00320UL-XX	8AWG	10AWG	20 or 25 @@	15	Optional
G540-00380UL-XX	6AWG	10AWG	20	15	Required
G540-00450UL-XX	6AWG	8AWG	20	15	Required
G540-00600UL-XX	3AWG	8AWG	25.5	18	Required
G540-00750UL-XX	3AWG	6AWG	25.5	18	Required
G540-00920UL-XX	2/0	6AWG	25.5	75	Required
G540-01150UL-XX	2/0	6AWG	25.5	75	Required
G540-01500UL-XX	3/0AWG	1AWG	60 or 80 \$\$	10	Required
G540-01800UL-XX	3/0AWG	1AWG	60 or 80 \$\$	10	Required
G540-02150UL-XX	1/0 AWG x 2	1AWG	90	10	Required
G540-02600UL-XX	350kcmil x 2	1AWG	338.2	338.2	Optional
G540-03050UL-XX					
G540-03400UL-XX					
G540-03800UL-XX					
G540-04250UL-XX					

Model number	Recommended cable size (AWG)		Required torque (in-lbs)		Wire connector (##)
	R, S, T; U, V, W; P1, (+), PB, (-)	PE	R, S, T; U, V, W; P1, (+), PB, (-)	PE	
G540-04800UL-XX	350kcmil x 3	4/0AWG	338.2	338.2	Optional
G540-05300UL-XX					
G540-06000UL-XX					
G540-06500UL-XX					
G540-07200UL-XX	350kcmil x 4	4/0AWG	338.2	338.2	Optional
G540-08600UL-XX					
G540-08600HDUL-XX					
G560-00021UL-XX	14AWG	14AWG	11	10	Optional
G560-00032UL-XX	14AWG	14AWG	11	10	Optional
G560-00045UL-XX	14AWG	14AWG	11	10	Optional
G560-00065UL-XX	14AWG	14AWG	20 or 25 @@	15	Optional
G560-00090UL-XX	12AWG	12AWG	20 or 25 @@	15	Optional
G560-00120UL-XX	10AWG	10AWG	20 or 25 @@	15	Optional
G560-00160UL-XX	10AWG	10AWG	20	15	Optional
G560-00210UL-XX	10AWG	10AWG	20	15	Optional
G560-00270UL-XX	8AWG	10AWG	20	15	Optional
G560-00350UL-XX	4AWG	8AWG	22 or 60 or 49.5 ##	10	Required
G560-00450UL-XX					
G560-00520UL-XX					
G560-00620UL-XX	3/0AWG	2AWG	60	10	Required
G560-00860UL-XX					
G560-00980UL-XX					
G560-01200UL-XX					
G560-01500UL-XX					
Control terminal block	26-14(Str/Sol) AWG	--	4.5	--	Optional

Note:

- It is appropriate to use the recommended cable size at 40°C and rated current. The wiring distance cannot be more than 100m.
- Terminals P1, (+), PB and (-) connect the DC reactor options and parts.
- Use 75°C CU wire only for field input and output wire.
- Note "@@":

Using SUCCEED's Terminal Block: "Tightening Torque shall be 20 in-lb" or equivalent.

Using DEGSON's Terminal Block: "Tightening Torque shall be 25 in-lb" or equivalent.

- Note "\$\$":
Using SUCCEED's Terminal Block: "Tightening Torque shall be 60 in-lb" or equivalent.
Using DEGSON's Terminal Block: "Tightening Torque shall be 80 in-lb" or equivalent
- Note "##":
Using SUCCEED's Terminal Block: "Tightening Torque shall be 22 in-lb" or equivalent.
Using DEGSON's Terminal Block: "Tightening Torque shall be 60 in-lb" or equivalent.
Using CONNECTION's Terminal Block: "Tightening Torque shall be 49.5 in-lb" or equivalent.

D.4.3 Cable arrangement

Motor cables must be arranged away from other cables. The motor cables of several inverters can be arranged in parallel. It is recommended that you arrange the motor cables, input power cables, and control cables separately in different trays. The output dU/dt of the inverters may increase electromagnetic interference on other cables. Do not arrange other cables and the motor cables in parallel.

If a control cable and power cable must cross each other, ensure that the angle between them is 90 degrees.

The cable trays must be connected properly and well grounded. Aluminum trays can implement local equipotential.

The following figure shows the cable arrangement distance requirements.

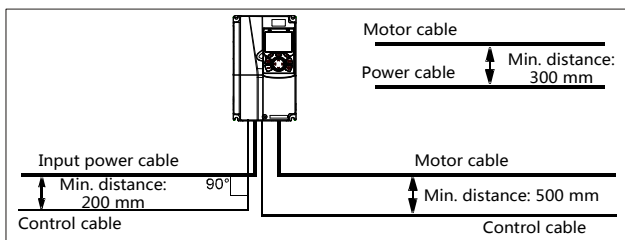

Cable arrangement distances

D.4.4 Insulation inspection

Check the motor and the insulation conditions of the motor cable before running the motor.

1. Ensure that the motor cable is connected to the motor, and then remove the motor cable from the U, V, and W output terminals of the inverter.
2. Use a megameter of 500 V DC to measure the insulation resistance between each phase conductor and the protection grounding conductor. For details about the insulation resistance of the motor, see the description provided by the manufacturer.

Note: The insulation resistance is reduced if it is damp inside the motor. If it may be damp, you need to dry the motor and then measure the insulation resistance again.

D.5 Breaker and electromagnetic contactor

You need to add a fuse to prevent overload.

You need to configure a manually manipulated molded case circuit breaker (MCCB) between the AC power supply and inverter. The breaker must be locked in the open state to facilitate installation and inspection. The capacity of the breaker needs to be 1.5 to 2 times the rated current of the inverter.



According to the working principle and structure of breakers, if the manufacturer's regulation is not followed, hot ionized gases may escape from the breaker enclosure when a short circuit occurs. To ensure safe use, exercise extra caution when installing and placing the breaker. Follow the manufacturer's instructions.

To ensure safety, you can configure an electromagnetic contactor on the input side to control the switch-on and switch-off of the main circuit power, so that the input power supply of the inverter can be effectively cut off when a system fault occurs.

Model	Max Prospective line Isc	Fuse class type	Fuse current rating
G520-00045UL-XX	10kA	CC	20 A/ 600 V
G520-00070UL-XX	10kA	CC	20 A/ 600 V
G520-00100UL-XX	10kA	CC	20 A/ 600 V
G520-00160UL-XX	10kA	T	40 A/ 600 V
G520-00200UL-XX	10kA	T	50 A/ 600 V
G520-00300UL-XX	10kA	T	50 A/ 600 V
G520-00420UL-XX	10kA	T	90 A/ 600 V
G520-00550UL-XX	10kA	T	125 A/ 600 V
G520-00700UL-XX	10kA	T	150 A/ 600 V
G520-00800UL-XX	10kA	T	150 A/ 600 V
G520-01100UL-XX	10kA	T	200 A/ 600 V
G520-01300UL-XX	10kA	T	250A/600V
G520-01600UL-XX	10kA	T	250A/600V
G520-02000UL-XX	10kA	T	250A/600V
G540-00037UL-XX	5kA	CC	20A/600V
G540-00050UL-XX	5kA	CC	20A/600V
G540-00140UL-XX	5kA	CC	20A/600V
G540-00185UL-XX	5kA	CC	30A/600V
G540-00250UL-XX	5kA	T	40A/600V
G540-00320UL-XX	5kA	T	50A/600V
G540-00380UL-XX	5kA	T	50A/600V
G540-00450UL-XX	5kA	T	80A/600V
G540-00600UL-XX	10kA	T	90A/600V
G540-00750UL-XX	10kA	T	125A/600V
G540-00920UL-XX	10kA	T	150A/600V
G540-01150UL-XX	10kA	T	200A/600V
G540-01500UL-XX	10kA	T	200A/600V

Model	Max Prospective line Isc	Fuse class type	Fuse current rating
G540-01800UL-XX	10kA	T	400A/600V
G540-02150UL-XX	10kA	T	400A/600V
G540-02600UL-XX	100kA	/	600A/600V
G540-03050UL-XX	100kA	/	600A/600V
G540-03400UL-XX	100kA	/	600A/600V
G540-03800UL-XX	100kA	/	600A/600V
G540-04250UL-XX	100kA	/	600A/600V
G540-04800UL-XX	100kA	/	600A/600V
G540-05300UL-XX	100kA	/	900A/600V
G540-06000UL-XX	100kA	/	900A/600V
G540-06500UL-XX	100kA	/	1500A/600V
G540-07200UL-XX	100kA	/	1500A/600V
G540-08600UL-XX	100kA	/	1500A/600V
G540-08600HDUL-XX	100kA	/	1500A/600V
G560-00021UL-XX	5kA	T	10A/600V
G560-00032UL-XX	5kA	T	10A/600V
G560-00045UL-XX	5kA	T	15A/600V
G560-00065UL-XX	5kA	T	15A/600V
G560-00090UL-XX	5kA	T	20A/600V
G560-00120UL-XX	5kA	T	25A/600V
G560-00160UL-XX	5kA	T	30A/600V
G560-00210UL-XX	5kA	T	40A/600V
G560-00270UL-XX	5kA	T	45A/600V
G560-00350UL-XX	5kA	T	100A/600V
G560-00450UL-XX	5kA	T	100A/600V
G560-00520UL-XX	5kA	T	100A/600V
G560-00620UL-XX	10kA	T	250A/600V
G560-00860UL-XX	10kA	T	250A/600V
G560-00980UL-XX	10kA	T	250A/600V
G560-01200UL-XX	10kA	T	250A/600V
G560-01500UL-XX	10kA	T	250A/600V

Integral solid state short circuit protection does not provide branch circuit protection. Branch circuit protection must be provided in accordance with the National Electrical Code and any additional local codes.

D.6 Reactors

When the voltage of the grid is high, the transient large current that flows into the input power circuit may damage rectifier components. You need to configure an AC reactor on the input side, which can also improve the current adjustment coefficient on the input side.

If the distance between the inverter and the motor is longer than 50m, frequent overcurrent protection may occur to the inverter because of high leakage current caused by parasitic capacitance effects from the long cables to the ground. In order to avoid the damage of the motor insulation, it is necessary to add reactor compensation.

The inverters of 220V (18.5kW/25HP - 55kW/75HP), 460V (≥ 37 kW/50HP) can be connected to external DC reactor for the improvement of power factors and the avoidance of damage from high input current to the rectifying components because of the high-capacity transformer. The device can also cease the damage to the rectifying components which are caused by supply net voltage transients and harmonic waves of the loads. If the distance between the inverter and motor is longer than 150m, contact Galt Electric technical support.

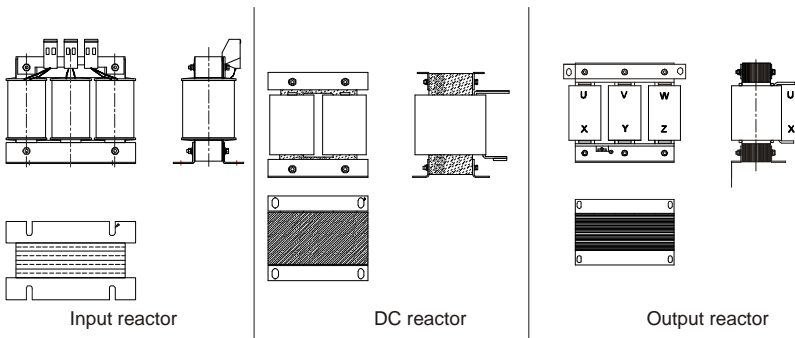

Model	Input reactor	DC reactor	Output reactor
G520-00045UL-XX	ACL2-2R2-4-UL	DCL2-2R2-4-UL	OCL2-2R2-4-UL
G520-00070UL-XX	ACL2-004-4-UL	DCL2-004-4-UL	OCL2-004-4-UL
G520-00100UL-XX	ACL2-004-4-UL	DCL2-004-4-UL	OCL2-004-4-UL
G520-00160UL-XX	ACL2-7R5-4-UL	DCL2-7R5-4-UL	OCL2-7R5-4-UL
G520-00200UL-XX	ACL2-011-4-UL	DCL2-015-4-UL	OCL2-011-4-UL
G520-00300UL-XX	ACL2-015-4-UL	DCL2-015-4-UL	OCL2-015-4-UL
G520-00420UL-XX	ACL2-022-4-UL	DCL2-022-4-UL	OCL2-022-4-UL
G520-00550UL-XX	ACL2-030-4-UL	DCL2-030-4-UL	OCL2-030-4-UL
G520-00700UL-XX	ACL2-037-4-UL	DCL2-037-4-UL	OCL2-037-4-UL
G520-00800UL-XX	ACL2-045-4-UL	DCL2-045-4-UL	OCL2-045-4-UL
G520-01100UL-XX	ACL2-055-4-UL	DCL2-055-4-UL	OCL2-055-4-UL
G520-01300UL-XX	ACL2-075-4-UL	DCL2-075-4-UL	OCL2-075-4-UL

Model	Input reactor	DC reactor	Output reactor
G520-01600UL-XX	ACL2-110-4-UL	DCL2-090-4-UL	OCL2-110-4-UL
G520-02000UL-XX	ACL2-110-4-UL	DCL2-132-4-UL	OCL2-110-4-UL
G540-00037UL-XX	ACL2-1R5-4-UL	DCL2-2R2-4-UL	OCL2-1R5-4-UL
G540-00050UL-XX	ACL2-2R2-4-UL	DCL2-2R2-4-UL	OCL2-2R2-4-UL
G540-00140UL-XX	ACL2-004-4-UL	DCL2-004-4-UL	OCL2-004-4-UL
G540-00185UL-XX	ACL2-5R5-4-UL	DCL2-7R5-4-UL	OCL2-5R5-4-UL
G540-00250UL-XX	ACL2-7R5-4-UL	DCL2-7R5-4-UL	OCL2-7R5-4-UL
G540-00320UL-XX	ACL2-011-4-UL	DCL2-015-4-UL	OCL2-011-4-UL
G540-00380UL-XX	ACL2-015-4-UL	DCL2-015-4-UL	OCL2-015-4-UL
G540-00450UL-XX	ACL2-018-4-UL	DCL2-018-4-UL	OCL2-018-4-UL
G540-00600UL-XX	ACL2-022-4-UL	DCL2-022-4-UL	OCL2-022-4-UL
G540-00750UL-XX	ACL2-030-4-UL	DCL2-030-4-UL	OCL2-030-4-UL
G540-00920UL-XX	ACL2-037-4-UL	DCL2-037-4-UL	OCL2-037-4-UL
G540-01150UL-XX	ACL2-045-4-UL	DCL2-045-4-UL	OCL2-045-4-UL
G540-01500UL-XX	ACL2-055-4-UL	DCL2-055-4-UL	OCL2-055-4-UL
G540-01800UL-XX	ACL2-075-4-UL	DCL2-075-4-UL	OCL2-075-4-UL
G540-02150UL-XX	ACL2-110-4-UL	DCL2-090-4-UL	OCL2-110-4-UL
G540-02600UL-XX	ACL2-110-4-UL	DCL2-132-4-UL	OCL2-110-4-UL
G540-03050UL-XX	ACL2-132-4-UL	DCL2-132-4-UL	OCL2-132-4-UL
G540-03400UL-XX	ACL2-160-4-UL	DCL2-160-4-UL	OCL2-160-4-UL
G540-03800UL-XX	ACL2-200-4-UL	DCL2-220-4-UL	OCL2-200-4-UL
G540-04250UL-XX	ACL2-200-4-UL	DCL2-220-4-UL	OCL2-200-4-UL
G540-04800UL-XX	Standard configuration	DCL2-220-4-UL	OCL2-250-4-UL
G540-05300UL-XX		DCL2-280-4-UL	OCL2-250-4-UL
G540-06000UL-XX		DCL2-280-4-UL	OCL2-280-4-UL
G540-06500UL-XX		DCL2-315-4-UL	OCL2-315-4-UL
G540-07200UL-XX	Standard configuration	DCL2-400-4-UL	OCL2-350-4-UL
G540-08600UL-XX		DCL2-400-4-UL	OCL2-400-4-UL
G540-08600HDUL-XX		DCL2-500-4-UL	OCL2-500-4-UL
G560-00021UL-XX	ACL2-2R2-6-UL	/	OCL2-2R2-6-UL
G560-00032UL-XX			
G560-00045UL-XX			
G560-00065UL-XX	ACL2-7R5-6-UL	/	OCL2-7R5-6-UL
G560-00090UL-XX			
G560-00120UL-XX			

Model	Input reactor	DC reactor	Output reactor
G560-00160UL-XX	ACL2-018-6-UL	/	OCL2-018-6-UL
G560-00210UL-XX			
G560-00270UL-XX			
G560-00350UL-XX	ACL2-030-6-UL	DCL2-030-6-UL	ACL2-030-6-UL
G560-00450UL-XX	ACL2-055-6-UL	DCL2-055-6-UL	ACL2-055-6-UL
G560-00520UL-XX	ACL2-055-6-UL	DCL2-055-6-UL	OCL2-055-6-UL
G560-00620UL-XX	ACL2-055-6-UL	DCL2-055-6-UL	OCL2-055-6-UL
G560-00860UL-XX	ACL2-011-6-UL	DCL2-011-6-UL	OCL2-011-6-UL
G560-00980UL-XX	ACL2-110-6-UL	DCL2-110-6-UL	OCL2-110-6-UL
G560-01200UL-XX	ACL2-110-6-UL	DCL2-110-6-UL	OCL2-110-6-UL
G560-01500UL-XX	ACL2-185-6-UL	DCL2-185-6-UL	OCL2-185-6-UL

Note:

1. The rated input voltage drop of input reactors is 2%±15%.
2. The power factor on the input side of the inverter is higher than 90% after a DC reactor is configured.
3. The rated output voltage drop of output reactors is 1%±15%.
4. The preceding table describes external accessories. You need to specify the ones you choose when purchasing accessories.

D.7 Filters

G500 series inverters are configured with built-in C3 filters which can be connected by J10.

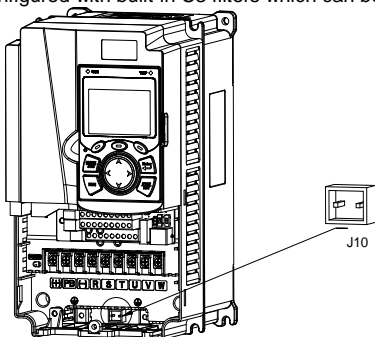

Note: Do not connect C3 filters in IT power systems.

Interference filters on the input side can reduce the interference of inverters (when used) on the surrounding devices.

Noise filters on the output side can decrease the radio noise caused by the cables between inverters and motors and the leakage current of conducting wires.

Some of the filters are provided for users to choose.

D.7.1 Filter model description

FLT - P 04 045 L - B

Field identifier	Field description
A	FLT: Name of the inverter filter series
B	Filter type P: Power input filter L: Output filter
C	Voltage class 04: AC 3PH 380V–480V 06: AC 3PH 520V–600V
D	3-digit code indicating the rated current. For example, 015 indicates 15 A.
E	Filter performance L: General H: High-performance
F	Filter application environment A: Environment Category I, C1 (EN 61800-3:2004) B: Environment Category I, C2 (EN 61800-3:2004) C: Environment Category II, C3 (EN 61800-3:2004)

D.7.2 Filters

Model	Input filter	Output filter
G520-00045UL-XX	FLT-P04006L-B	FLT-L04006L-B
G520-00070UL-XX	FLT-P04016L-B	FLT-L04016L-B
G520-00100UL-XX		
G520-00160UL-XX	FLT-P04032L-B	FLT-L04032L-B
G520-00200UL-XX		
G520-00300UL-XX	FLT-P04045L-B	FLT-L04045L-B
G520-00420UL-XX	FLT-P04065L-B	FLT-L04065L-B
G520-00550UL-XX		
G520-00700UL-XX	FLT-P04100L-B	FLT-L04100L-B
G520-00800UL-XX		
G520-01100UL-XX	FLT-P04150L-B	FLT-L04150L-B
G520-01300UL-XX		
G520-01600UL-XX	FLT-P04200L-B	FLT-L04200L-B
G520-02000UL-XX	FLT-P04250L-B	FLT-L04250L-B
G540-00037UL-XX	FLT-P04006L-B	FLT-L04006L-B
G540-00050UL-XX		

Model	Input filter	Output filter
G540-00140UL-XX	FLT-P04016L-B	FLT-L04016L-B
G540-00185UL-XX		
G540-00250UL-XX	FLT-P04032L-B	FLT-L04032L-B
G540-00320UL-XX		
G540-00380UL-XX	FLT-P04045L-B	FLT-L04045L-B
G540-00450UL-XX		
G540-00600UL-XX	FLT-P04065L-B	FLT-L04065L-B
G540-00750UL-XX		
G540-00920UL-XX	FLT-P04100L-B	FLT-L04100L-B
G540-01150UL-XX		
G540-01500UL-XX	FLT-P04150L-B	FLT-L04150L-B
G540-01800UL-XX		
G540-02150UL-XX	FLT-P04200L-B	FLT-L04200L-B
G540-02600UL-XX		
G540-03050UL-XX	FLT-P04250L-B	FLT-L04250L-B
G540-03400UL-XX		
G540-03800UL-XX	FLT-P04400L-B	FLT-L04400L-B
G540-04250UL-XX		
G540-04800UL-XX	FLT-P04600L-B	FLT-L04600L-B
G540-05300UL-XX		
G540-06000UL-XX	FLT-P04800L-B	FLT-L04800L-B
G540-06500UL-XX		
G540-07200UL-XX	FLT-P04800L-B	FLT-L04800L-B
G540-08600UL-XX		
G540-08600HDUL-XX	FLT-P041000L-B	FLT-L041000L-B
G560-00270UL-XX	FLT-P06050H-B	FLT-L06050H-B
G560-00350UL-XX		
G560-00450UL-XX	FLT-P06100H-B	FLT-L06100H-B
G560-00520UL-XX		
G560-00620UL-XX	FLT-P06100H-B	FLT-L06100H-B
G560-00860UL-XX		
G560-00980UL-XX	FLT-P06200H-B	FLT-L06200H-B
G560-01200UL-XX		



Note:

1. The input EMI meets the C2 requirements after an input filter is configured.
2. The preceding table describes external accessories. You need to specify the ones you choose when purchasing accessories.

D.8 Brake system

D.8.1 Brake component selection

When an inverter driving a high-inertia load decelerates or needs to decelerate abruptly, the motor runs in the power generation state and transmits the load-carrying energy to the DC circuit of the inverter, causing the bus voltage of the inverter to rise. If the bus voltage exceeds a specific value, the inverter reports an overvoltage fault. To prevent this from happening, you need to configure brake components.

	<ul style="list-style-type: none"> • The design, installation, commissioning, and operation of the device must be performed by trained and qualified professionals. • Follow all the "Warning" instructions during the operation. Otherwise, major physical injuries or property loss may be caused. • Only qualified electricians are allowed to perform the wiring. Otherwise, damage to the inverter or brake components may be caused. • Read the brake resistor or unit instructions carefully before connecting them to the inverter. • Connect brake resistors only to the terminals PB and (+), and brake units only to the terminals (+) and (-). Do not connect them to other terminals. Otherwise, damage to the brake circuit and inverter and fire may be caused.
	Connect the brake components to the inverter according to the wiring diagram. If the wiring is not properly performed, damage to the inverter or other devices may be caused.

G500 series inverters below 220V ($\leq 15\text{kW}/20\text{HP}$), 460V ($\leq 30\text{kW}/40\text{HP}$) need internal brake units and the inverters 220V ($\geq 18.5\text{kW}$), 460V ($\geq 37\text{kW}/50\text{HP}$) need external brake units. Select the resistance and power of brake resistors according to actual utilization.

The inverters of 220V ($\leq 15\text{kW}/20\text{HP}$), 460V ($\leq 30\text{kW}/40\text{HP}$), and 575V ($\leq 18.5\text{kW}/25\text{HP}$) are configured with brake units but brake units are optional for the other models. Select brake resistors according to actual operation.



Model	Model of brake unit	Brake resistor at 100% of braking torque (Ω)	Consumed power of brake resistor (kW)			Min. allowable braking resistance (Ω)
			10% braking	50% braking	80% braking	
G520-00045UL-XX	Embedded brake unit	192	0.11	0.56	0.9	93
G520-00070UL-XX		96	0.23	1.1	1.8	44
G520-00100UL-XX		65	0.33	1.7	2.64	44
G520-00160UL-XX		36	0.6	3	4.8	33
G520-00200UL-XX		26	0.75	4.13	6.6	25
G520-00300UL-XX		19	1.13	5.63	9	13
G520-00420UL-XX		13	1.6	8	12.8	8.8
G520-00550UL-XX		9.6	2	11	18	6.4

Model	Model of brake unit	Brake resistor at 100% of braking torque (Ω)	Consumed power of brake resistor (kW)			Min. allowable braking resistance (Ω)	
			10% braking	50% braking	80% braking		
G520-00700UL-XX	DBU100H-060-2	8	3	14	22	6.4	
G520-00800UL-XX	DBU100H-110-2	6.5	3	17	26	6.4	
G520-01100UL-XX		4.8	5	23	36	3.5	
G520-01300UL-XX		3.9	6	28	44		
G520-01600UL-XX		DBU100H-160-2	3.2	7	34	54	2.4
G520-02000UL-XX	2.6		8	41	66		
G540-00037UL-XX	Embedded brake unit	326	0.23	1.1	1.8	170	
G540-00050UL-XX		222	0.33	1.7	2.6	130	
G540-00140UL-XX		122	0.6	3	4.8	80	
G540-00185UL-XX		89	0.75	4.1	6.6	60	
G540-00250UL-XX		65	1.1	5.6	9	47	
G540-00320UL-XX		44	1.7	8.3	13.2	31	
G540-00380UL-XX		32	2	11	18	23	
G540-00450UL-XX		27	3	14	22	19	
G540-00600UL-XX		22	3	17	26	17	
G540-00750UL-XX		16	5	23	36	17	
G540-00920UL-XX		DBU100H-060-4	13	6	28	44	11.7
G540-01150UL-XX		DBU100H-110-4	10	7	34	54	6.4
G540-01500UL-XX	8		8	41	66		
G540-01800UL-XX	6.5		11	56	90		
G540-02150UL-XX	DBU100H-160-4	5.4	14	68	108	4.4	
G540-02600UL-XX		4.5	14	83	132		
G540-03050UL-XX	DBU100H-220-4	3.7	20	99	158	3.2	
G540-03400UL-XX	DBU100H-320-4	3.1	24	120	192	2.2	
G540-03800UL-XX		2.8	28	139	222		
G540-04250UL-XX		2.5	30	150	240		
G540-04800UL-XX	DBU100H-400-4	2.2	33	165	264	1.8	
G540-05300UL-XX		2.0	38	188	300		
G540-06000UL-XX	TWO DBU100H-320-4	3.6*2	21*2	105*2	168*2	2.2*2	
G540-06500UL-XX		3.2*2	24*2	118*2	189*2		
G540-07200UL-XX		2.8*2	27*2	132*2	210*2		
G540-08600UL-XX		2.4*2	30*2	150*2	240*2		
G540-08600HDUL-XX	TWO DBU100H-400-4	2*2	38*2	186*2	300*2	1.8*2	

Model	Model of brake unit	Brake resistor at 100% of braking torque (Ω)	Consumed power of brake resistor (kW)			Min. allowable braking resistance (Ω)
			10% braking	50% braking	80% braking	
G560-00021UL-XX	Embedded braking unit	707	0.2	0.7	1.1	470
G560-00032UL-XX		464	0.3	1.4	2.2	300
G560-00045UL-XX		330	0.5	2.0	3.2	220
G560-00065UL-XX		228	0.9	3.7	5.8	150
G560-00090UL-XX		165	1.2	5.1	8.0	110
G560-00120UL-XX		123	1.4	7.5	12.3	82
G560-00160UL-XX		93	2	11	18	62
G560-00210UL-XX		70	3	14	22	47
G560-00270UL-XX		55	4	17	27	36
G560-00350UL-XX	DBU100H-110-6	40.3	5	23	36	10.0
G560-00450UL-XX		32.7	6	28	44	
G560-00520UL-XX		26.9	7	34	54	
G560-00620UL-XX		22.0	8	41	66	
G560-00860UL-XX		16.1	11	56	90	
G560-00980UL-XX		13.4	14	68	108	
G560-01200UL-XX		11.0	17	83	132	
G560-01500UL-XX	DBU100H-160-6	9.2	20	99	158	6.9

Note:

1. Select brake resistors according to the resistance and power data provided by our company.
2. The brake resistor may increase the brake torque of the inverter. The preceding table describes the resistance and power for 100% brake torque, 10% brake usage, 50% brake usage, and 80% brake usage. You can select the brake system based on the actual operation conditions.
3. When using an external brake unit, set the brake voltage class of the brake unit properly by referring to the manual of the dynamic brake unit. If the voltage class is set incorrectly, the inverter may not run properly.

	Do not use brake resistors whose resistance is lower than the specified minimum resistance. Inverters do not provide protection against overcurrent caused by resistors with low resistance.
	In scenarios where brake is frequently implemented, that is, the brake usage is greater than 10%, you need to select a brake resistor with higher power as required by the operation conditions according to the preceding table.

D.8.2 Brake resistor cable selection

Brake resistor cables need to be shielded cables.

D.8.3 Brake resistor installation

All resistors need to be installed in places with good cooling conditions.

	<p>The materials near the brake resistor or brake unit must be non-flammable. The surface temperature of the resistor is high. Air flowing from the resistor is of hundreds of degrees Celsius. Prevent any materials from coming into contact with the resistor.</p>
---	---

Installation of brake resistors

	<ul style="list-style-type: none"> The inverters of 220V ($\leq 15\text{kW}/20\text{HP}$), 460V ($\leq 30\text{kW}/40\text{HP}$), and 575V ($\leq 18.5\text{kW}/25\text{HP}$) only need external brake resistors. PB and (+) are the wiring terminals of the brake resistors.
---	--

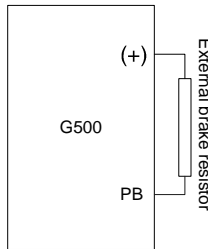

Installation of brake units

	<ul style="list-style-type: none"> The inverters of 220V ($\geq 18.5\text{kW}/25\text{HP}$), 460V ($\geq 37\text{kW}/50\text{HP}$), and 575V ($\geq 22\text{kW}/30\text{HP}$) need external braking units. (+), (-) are the wiring terminals of the braking units. The wiring length between the (+), (-) terminals of the inverter and the (+), (-) terminals of the braking units should be no more than 5m, and the distributing length among BR1 and BR2 and the braking resistor terminals should be no more than 10m.
---	---

The following figure shows the connection of one inverter to a dynamic brake unit.

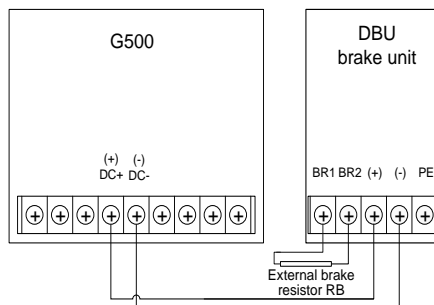

Appendix E STO function description

Reference standards: IEC 61508-1, IEC 61508-2, IEC 61508-3, IEC 61508-4, IEC 62061, ISO 13849-1, and IEC 61800-5-2

You can enable the safe torque off (STO) function to prevent unexpected startups when the main power supply of the drive is not switched off. The STO function switches off the drive output by turning off the drive signals to prevent unexpected startups of the motor (see the following figure). After the STO function is enabled, you can perform some-time operations (such as non-electrical cleaning in the lathe industry) and maintain the non-electrical components of the device without switching off the drive.

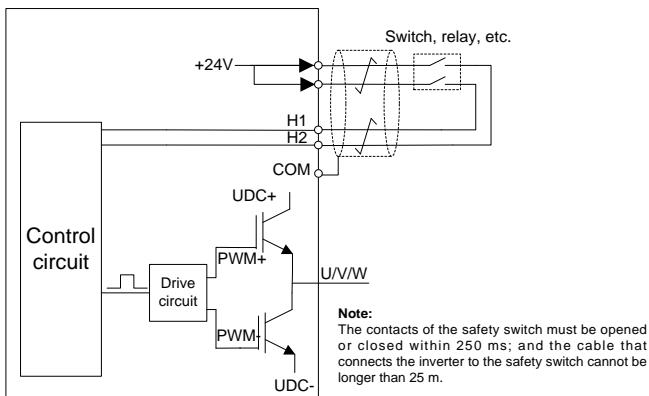

E.1 STO function logic table

The following table describes the input states and corresponding faults of the STO function.

STO input state	Corresponding fault
H1 and H2 opened simultaneously	The STO function is triggered, and the drive stops running. Fault code: 40: Safe torque off (STO)
H1 and H2 closed simultaneously	The STOP function is not triggered, and the drive runs properly.
One of H1 and H2 opened, and the other closed	The STL1, STL2, or STL3 fault occurs. Fault code: 41: Channel H1 exception (STL1) 42: Channel H2 exception (STL2) 43: Channel H1 and H2 exceptions (STL3)

E.2 STO channel delay description

The following table describes the trigger and indication delay of the STO channels.

STO mode	STO trigger delay ¹ and indication delay ²
STO fault: STL1	Trigger delay < 10 ms Indication delay < 280 ms
STO fault: STL2	Trigger delay < 10 ms Indication delay < 280 ms
STO fault: STL3	Trigger delay < 10 ms Indication delay < 280 ms
STO fault: STO	Trigger delay < 10 ms Indication delay < 100 ms

1. STO function trigger delay: Time interval between trigger the STO function and switching off the drive output
2. STO indication delay: Time interval between trigger the STO function and STO output state indication

E.3 STO function installation checklist

Before installing the STO, check the items described in the following table to ensure that the STO function can be properly used.

	Item
<input type="checkbox"/>	Ensure that the drive can be run or stopped randomly during commissioning.
<input type="checkbox"/>	Stop the drive (if it is running), disconnect the input power supply, and isolate the drive from the power cable through the switch.
<input type="checkbox"/>	Check the STO circuit connection according to the circuit diagram.
<input type="checkbox"/>	Check whether the shielding layer of the STO input cable is connected to the +24 V reference ground COM.
<input type="checkbox"/>	Connect the power supply.
<input type="checkbox"/>	Test the STO function as follows after the motor stops running: <ul style="list-style-type: none"> ● If the drive is running, send a stop command to it and wait until the shaft of the motor stops rotating. ● Activate the STO circuit and send a start command to the drive. Ensure that the motor does not start. ● Deactivate the STO circuit.
<input type="checkbox"/>	Restart the drive, and check whether the motor is running properly.
<input type="checkbox"/>	Test the STO function as follows when the motor is running: <ul style="list-style-type: none"> ● Start the drive. Ensure that the motor is running properly. ● Activate the STO circuit. ● The drive reports an STO fault (for details, see Section 7.5 "Inverter faults and corresponding solutions"). Ensure that the motor coasts to stop rotating. ● Deactivate the STO circuit.
<input type="checkbox"/>	Restart the drive, and check whether the motor is running properly.

Appendix F Acronyms and abbreviations

This chapter describes the acronyms and abbreviations of the terms or words that may be used on the interfaces of the keypad.

Term/word	Acronym/abbreviation	Term/word	Acronym/abbreviation
Accumulated/accumulation	Accum	Inverter	Inv
Address	Addr	Leakage	Lkge
Amplitude	Amp	Lower limit	LowLim
Bridge	Brdg	Low-frequency	LwFreq
Coefficient	Coeff	Low-speed	LwSp
Combination	Comb	Master/slave	M/S
Command	Cmd	Operation/operate/operator	Oper
Communication	Comm	Output	Outp
Compensation	Comp	Parameter	Param
Component	Cmpt	Password	Pwd
Consumption	Consume	Position	Pos
Control	Ctrl	Power	Pwr
Current	Cur	Proportional	Prop
Detection/detect	Det	Protect/protection	Prot
Differential	Diff	Quantity	Qty
Digital	Digi	Reference	Ref
Display	Disp	Resistance	Resis
Dynamic	Dyn	Reverse	REV
Eelectromotive force	Emf	Saturation	Satur
Emergency	Emer	Short-circuit	S/C
Error	Err	Source	Src
Factor	Fac	Speed	Spd
Feedback	Fdbk	Spindle	Spdl
Filter/filtering	Filt	Switch	Swt
Forward	FWD	System	SYS
Frequency	Freq	Temperature	Temp
Frequency point	FreqPnt	Terminal	Trml
Friction	Frict	Threshold	Thr
High-speed	HiSp	Torque	Trq
Identification/identity	ID	Upper limit	UpLim
Inductance	Ind	Value	Val
Initial	Init	Version	Ver
Input	Inp	Vibration	Vib
Instance	Inst	Voltage	Volt
Integral	Intg	Voltage point	VoltPnt
Interval	Intvl		

Appendix G Further information

G.1 Product and service queries

Should you have any queries about the product, contact your distributor or manufacturer. Provide the model and serial number of the product you query about.

G.2 Feedback on Galt Electric Inverter manuals

Send any suggestions about our manuals to www.galtelectric.com, select **Online Feedback** or **Contact Us**.

G.3 Documents on the Internet

You can find manuals and other product documents in PDF format on www.galtelectric.com and select **Support**. Choose the appropriate category and product series to find the documentation.



GALT ELECTRIC

California USA
www.galtelectric.com
1-800-511-7734



Information is subjected to change without notice.

Copyright © 2022 Galt Electric. All Rights Reserved. Designated trademarks and brands are the property of their respective owners.

202211 (V1.5)